



Since 1977

PIMTAŞ®

PLASTİK İNŞ. MALZ.SAN. VE TİC. A.Ş.



U-PVC / HDPE / PP

ÜRÜN KATALOGU PRODUCT CATALOGUE

2022

İÇİNDEKİLER / INDEX

22-23	HAKKIMIZDA / ABOUT US
24-25	SERTİFİKALAR / CERTIFICATE
26-27	KİMYASALLARA DAYANIM / RESISTANCE TO CHEMICALS
29-36	U-PVC BORULAR / PIPES
37-52	U-PVC DEVE BOYNU BORULAR / LONG BEND PIPES
53-60	KELEPÇELER / PIPE CLAMP
61-68	TEKNİK MALZEMELER / TECHNICAL MATERIALS
69-74	U-PVC CONTALI EK PARÇALAR / GASKET SOCKETED FITTINGS
75-94	U-PVC EK PARÇALAR / FITTINGS
95-100	U-PVC RAKOR / UNION
101-110	U-PVC ÇEKVALF / CHECKVALVE
111-116	U-PVC KELEBEK VANALAR / BUTTERFLY VALVE
117-134	U-PVC AKTÜATÖRLÜ KELEBEK VANALAR / ACTUATOR BUTTERFLY VALVE
135-148	U-PVC KÜRESEL VANALAR / BALL VALVE
149-160	U-PVC AKTÜATÖRLÜ KÜRESEL VANALAR / ACTUATOR BALL VALVE
161-170	HDPE BORU / PIPE
171-178	HDPE VANA / VALVE
179-184	HDPE EF EK PARÇALAR / EF FITTINGS
185-198	HDPE SPİGOT EK PARÇALAR / SPIGOT FITTINGS
199-208	HDPE KONFEKSİYON EK PARÇALAR / HAND-MADE FITTINGS
209-214	PP-B KAPLIN VANALAR / COMPRESSION VALVES
215-228	PP-B KAPLIN MAVİ SERİ / COMPRESSION BLUE SERIES
229-238	PP-B KAPLIN YEŞİL SERİ / COMPRESSION GREEN SERIES
239-240	PP VANA KUTULARI / VALVE BOXES
241-252	U-PVC / PP PRİZ KOLYE / CLAMP SADDLE
253-256	MANDALLI YAĞMURLAMA BORU ve EK PARÇALARI / LATCHED IRRIGATION PIPE AND FITTINGS
257-262	DAMLA SULAMA BORULARI / DRIP IRRIGATION PIPE
263-274	DAMLA SULAMA ÜRÜNLERİ / DRIP IRRIGATION PRODUCT LINE
275-294	PP ÜRÜN GRUBU / PRODUCT LINE
295-320	PPRC ÜRÜN GRUBU / PRODUCT LINE
321-337	YEDEK PARÇALAR / SPARE PARTS

U-PVC BORULAR / U-PVC PIPES



sayfa/page: 30-31



sayfa/page: 32-33



sayfa/page: 34



sayfa/page: 35



sayfa/page: 35

U-PVC DEVEBOYNU BORULAR / U-PVC PIPES



sayfa/page: 38



sayfa/page: 39



sayfa/page: 40



sayfa/page: 41



sayfa/page: 42



sayfa/page: 43



sayfa/page: 44



sayfa/page: 45



sayfa/page: 46



sayfa/page: 47



sayfa/page: 48



sayfa/page: 49



sayfa/page: 50



sayfa/page: 51



sayfa/page: 51

KELEPÇELER / PIPE CLAMP



sayfa/page: 54



sayfa/page: 54



sayfa/page: 54



sayfa/page: 55



sayfa/page: 56



sayfa/page: 56



sayfa/page: 57



sayfa/page: 57



sayfa/page: 57



sayfa/page: 58



sayfa/page: 58



sayfa/page: 58



sayfa/page: 59



sayfa/page: 59



sayfa/page: 59



sayfa/page: 59

TEKNİK MALZEMELER / TECHNICAL MATERIALS



sayfa/page: 62



sayfa/page: 62



sayfa/page: 63



sayfa/page: 64



sayfa/page: 65



sayfa/page: 66



sayfa/page: 66-67



sayfa/page: 67



sayfa/page: 67



sayfa/page: 67



sayfa/page: 67



sayfa/page: 67

U-PVC CONTALI EK PARÇALAR / U-PVC GASKET SOCKETED FITTINGS



sayfa/page: 70



sayfa/page: 70



sayfa/page: 70



sayfa/page: 70



sayfa/page: 71



sayfa/page: 71



sayfa/page: 71



sayfa/page: 72



sayfa/page: 72



sayfa/page: 73



sayfa/page: 73



sayfa/page: 74



sayfa/page: 74



sayfa/page: 76



sayfa/page: 76



sayfa/page: 76



sayfa/page: 77



sayfa/page: 77



sayfa/page: 78



sayfa/page: 90



sayfa/page: 91



sayfa/page: 91



sayfa/page: 92



sayfa/page: 92



sayfa/page: 92



sayfa/page: 78



sayfa/page: 79



sayfa/page: 79



sayfa/page: 80



sayfa/page: 81



sayfa/page: 81



sayfa/page: 93



sayfa/page: 93



sayfa/page: 93



sayfa/page: 82



sayfa/page: 82-83



sayfa/page: 82-83



sayfa/page: 83



sayfa/page: 84



sayfa/page: 84

U-PVC RAKOR / U-PVC UNION



sayfa/page: 84



sayfa/page: 84



sayfa/page: 85



sayfa/page: 85



sayfa/page: 85



sayfa/page: 85



sayfa/page: 96



sayfa/page: 96



sayfa/page: 97



sayfa/page: 97



sayfa/page: 98



sayfa/page: 98



sayfa/page: 86



sayfa/page: 86



sayfa/page: 87



sayfa/page: 87



sayfa/page: 88



sayfa/page: 88



sayfa/page: 98



sayfa/page: 98



sayfa/page: 99



sayfa/page: 99



sayfa/page: 99



sayfa/page: 99



sayfa/page: 88



sayfa/page: 89



sayfa/page: 89

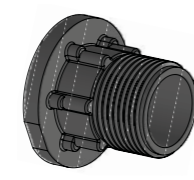

sayfa/page: 89



sayfa/page: 90



sayfa/page: 90



sayfa/page: 100



sayfa/page: 100



sayfa/page: 100



sayfa/page: 102 sayfa/page: 102-103 sayfa/page: 104 sayfa/page: 104 sayfa/page: 104 sayfa/page: 105



sayfa/page: 105 sayfa/page: 106 sayfa/page: 106-107 sayfa/page: 107 sayfa/page: 107 sayfa/page: 108



sayfa/page: 108 sayfa/page: 109 sayfa/page: 109 sayfa/page: 110

U-PVC KELEBEK VANA / U-PVC BUTTERFLY VALVE



sayfa/page: 112 sayfa/page: 113 sayfa/page: 114 sayfa/page: 115



sayfa/page: 118 sayfa/page: 119 sayfa/page: 120-123 sayfa/page: 121,125 sayfa/page: 126-130 sayfa/page: 127,131



sayfa/page: 132 sayfa/page: 132 sayfa/page: 132 sayfa/page: 132 sayfa/page: 132

U-PVC KÜRESEL VANA / U-PVC BALL VALVE



sayfa/page: 136 sayfa/page: 136 sayfa/page: 137 sayfa/page: 137 sayfa/page: 138 sayfa/page: 138



sayfa/page: 139 sayfa/page: 140 sayfa/page: 141 sayfa/page: 142 sayfa/page: 142 sayfa/page: 143



sayfa/page: 143 sayfa/page: 144 sayfa/page: 144-145 sayfa/page: 145 sayfa/page: 146 sayfa/page: 146



sayfa/page: 147 sayfa/page: 147

U-PVC AKTÜATÖRLÜ KÜRESEL VANA / U-PVC ACTUATOR BALL VALVE



sayfa/page: 150



sayfa/page: 150-151



sayfa/page: 151



sayfa/page: 152,155



sayfa/page: 153



sayfa/page: 156,159



sayfa/page: 157

HDPE EF EK PARÇALAR / HDPE EF FITTINGS



sayfa/page: 180



sayfa/page: 180



sayfa/page: 180



sayfa/page: 181



sayfa/page: 181



sayfa/page: 181



sayfa/page: 182



sayfa/page: 183

HDPE BORU-VANA / HDPE PIPE-VALVE



sayfa/page: 162,166



sayfa/page: 167,169



sayfa/page:172-173



sayfa/page:172



sayfa/page:172-173



sayfa/page: 174



sayfa/page: 174



sayfa/page: 175



sayfa/page: 175



sayfa/page: 175



sayfa/page: 175-177



sayfa/page: 176



sayfa/page: 176



sayfa/page: 176



sayfa/page: 177

HDPE SPİGOT ENJEKSİYON EK PARÇALAR / HDPE SPIGOT INJECTION FITTINGS



sayfa/page: 186



sayfa/page: 187



sayfa/page: 188



sayfa/page: 189



sayfa/page: 190-191



sayfa/page: 192



sayfa/page: 193



sayfa/page: 194-195



sayfa/page: 196



sayfa/page: 196



sayfa/page: 197



sayfa/page: 197



sayfa/page: 197

HDPE KONFEKSİYON EK PARÇALAR / HDPE HAND-MADE FITTINGS



sayfa/page: 200-201 sayfa/page: 202 sayfa/page: 202 sayfa/page: 203 sayfa/page: 203 sayfa/page: 204-205



sayfa/page: 206 sayfa/page: 207-208 sayfa/page: 207-208

PP-B KAPLİN VANALAR / PP-B COMPRESSIONS VALVES



sayfa/page: 210 sayfa/page: 210 sayfa/page: 211 sayfa/page: 211 sayfa/page: 212 sayfa/page: 212



sayfa/page: 213 sayfa/page: 213 sayfa/page: 213 sayfa/page: 214 sayfa/page: 214 sayfa/page: 214

PP-B KAPLİN MAVİ SERİ / PP-B COMPRESSIONS BLUE SERIES



sayfa/page: 216 sayfa/page: 217 sayfa/page: 218 sayfa/page: 218 sayfa/page: 219 sayfa/page: 219



sayfa/page: 220 sayfa/page: 220 sayfa/page: 221 sayfa/page: 222 sayfa/page: 223 sayfa/page: 224



sayfa/page: 224 sayfa/page: 225 sayfa/page: 226 sayfa/page: 227 sayfa/page: 228 sayfa/page: 226-227

PP-B KAPLİN YEŞİL SERİ / PP-B COMPRESSIONS GREEN SERIES



sayfa/page: 230 sayfa/page: 230 sayfa/page: 231 sayfa/page: 231 sayfa/page: 232 sayfa/page: 233



sayfa/page: 233 sayfa/page: 234 sayfa/page: 235 sayfa/page: 236 sayfa/page: 236 sayfa/page: 237



sayfa/page: 237 sayfa/page: 232

PP VANA KUTULARI / PP VALVE BOXES



sayfa/page: 240

sayfa/page: 240

sayfa/page: 240

sayfa/page: 240

DAMLA SULAMA BORU-EK PARÇA / DRIP IRRIGATION PIPE-FITTINGS



sayfa/page: 258-259

sayfa/page: 260-261

sayfa/page: 264

sayfa/page: 264

sayfa/page: 264

sayfa/page: 264

PVC/PP PRİZ KOLYE / PVC/PP CLAMP SADDLES



sayfa/page: 242

sayfa/page: 242

sayfa/page: 244

sayfa/page: 245

sayfa/page: 246

sayfa/page: 247



sayfa/page: 264

sayfa/page: 264

sayfa/page: 264

sayfa/page: 265

sayfa/page: 265

sayfa/page: 265



sayfa/page: 248

sayfa/page: 249

sayfa/page: 250

sayfa/page: 251

sayfa/page: 252

sayfa/page: 252



sayfa/page: 265

sayfa/page: 265

sayfa/page: 265

sayfa/page: 265

sayfa/page: 266

sayfa/page: 266



sayfa/page: 266

sayfa/page: 266

sayfa/page: 266

sayfa/page: 266

sayfa/page: 266

sayfa/page: 266

MANDALLI YAĞMURLAMA BORU ve EK PARÇALARI / LATCHED IRRIGATION PIPE AND FITTINGS



sayfa/page: 254

sayfa/page: 254

sayfa/page: 254

sayfa/page: 255

sayfa/page: 255

sayfa/page: 255



sayfa/page: 267

sayfa/page: 267

sayfa/page: 267

sayfa/page: 267

sayfa/page: 267

sayfa/page: 267



sayfa/page: 255

sayfa/page: 255

sayfa/page: 255

sayfa/page: 256

sayfa/page: 256

sayfa/page: 256



sayfa/page: 267

sayfa/page: 268

sayfa/page: 268

sayfa/page: 268

sayfa/page: 268

sayfa/page: 268



sayfa/page: 268



sayfa/page: 268



sayfa/page: 269



sayfa/page: 269



sayfa/page: 269



sayfa/page: 269



sayfa/page: 276



sayfa/page: 276-277



sayfa/page: 278



sayfa/page: 278-279



sayfa/page: 280



sayfa/page: 280-281



sayfa/page: 269



sayfa/page: 270



sayfa/page: 270



sayfa/page: 270



sayfa/page: 270



sayfa/page: 270



sayfa/page: 281



sayfa/page: 282-283



sayfa/page: 282-283



sayfa/page: 284



sayfa/page: 284-285



sayfa/page: 286



sayfa/page: 270



sayfa/page: 270



sayfa/page: 271



sayfa/page: 271



sayfa/page: 271



sayfa/page: 271



sayfa/page: 286



sayfa/page: 287



sayfa/page: 287



sayfa/page: 288



sayfa/page: 288-289



sayfa/page: 289



sayfa/page: 271



sayfa/page: 271



sayfa/page: 271



sayfa/page: 271



sayfa/page: 272



sayfa/page: 272



sayfa/page: 290



sayfa/page: 290-291



sayfa/page: 292



sayfa/page: 292



sayfa/page: 292



sayfa/page: 293



sayfa/page: 272



sayfa/page: 272



sayfa/page: 273



sayfa/page: 273



sayfa/page: 273



sayfa/page: 273



sayfa/page: 293



sayfa/page: 274



sayfa/page: 274

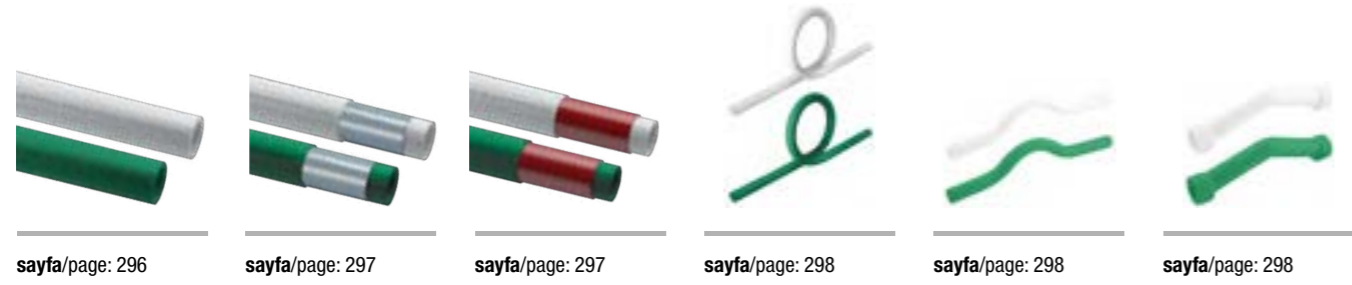

sayfa/page: 296 sayfa/page: 297 sayfa/page: 297 sayfa/page: 298 sayfa/page: 298 sayfa/page: 298



sayfa/page: 298 sayfa/page: 298 sayfa/page: 299 sayfa/page: 299 sayfa/page: 299 sayfa/page: 300



sayfa/page: 300 sayfa/page: 300 sayfa/page: 301 sayfa/page: 301 sayfa/page: 301 sayfa/page: 301



sayfa/page: 302 sayfa/page: 303 sayfa/page: 303 sayfa/page: 303 sayfa/page: 303 sayfa/page: 304



sayfa/page: 304 sayfa/page: 304 sayfa/page: 304 sayfa/page: 305 sayfa/page: 305 sayfa/page: 305

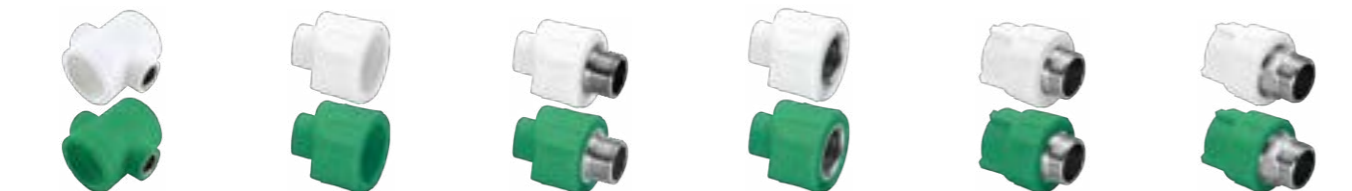

sayfa/page: 305 sayfa/page: 305 sayfa/page: 306 sayfa/page: 306 sayfa/page: 306 sayfa/page: 306

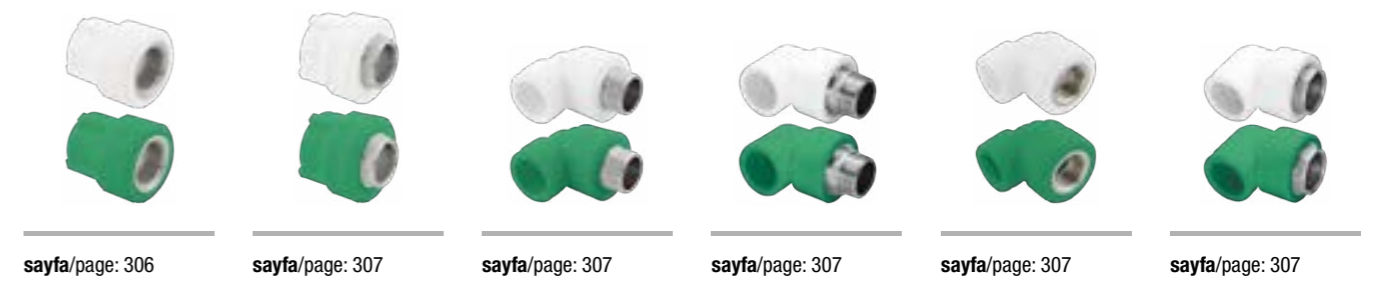

sayfa/page: 306 sayfa/page: 307 sayfa/page: 307 sayfa/page: 307 sayfa/page: 307 sayfa/page: 307



sayfa/page: 308 sayfa/page: 308 sayfa/page: 308 sayfa/page: 308 sayfa/page: 308 sayfa/page: 308



sayfa/page: 309 sayfa/page: 309 sayfa/page: 309 sayfa/page: 309 sayfa/page: 309 sayfa/page: 310



sayfa/page: 310 sayfa/page: 310 sayfa/page: 310 sayfa/page: 311 sayfa/page: 311 sayfa/page: 311



sayfa/page: 311 sayfa/page: 312 sayfa/page: 312 sayfa/page: 312 sayfa/page: 312 sayfa/page: 312



sayfa/page: 313 sayfa/page: 313 sayfa/page: 313 sayfa/page: 313 sayfa/page: 313 sayfa/page: 314



sayfa/page: 314



sayfa/page: 314



sayfa/page: 314



sayfa/page: 314



sayfa/page: 314



sayfa/page: 315



sayfa/page: 315



sayfa/page: 315

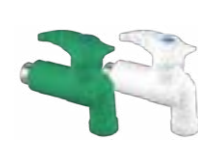

sayfa/page: 315



sayfa/page: 315



sayfa/page: 315



sayfa/page: 316



sayfa/page: 316



sayfa/page: 316



sayfa/page: 316



sayfa/page: 316



sayfa/page: 316



sayfa/page: 317



sayfa/page: 317



sayfa/page: 317



sayfa/page: 317



sayfa/page: 317



sayfa/page: 318



sayfa/page: 318



sayfa/page: 318



sayfa/page: 319



sayfa/page: 319



sayfa/page: 319



sayfa/page: 319



sayfa/page:320



sayfa/page: 320



sayfa/page: 320



sayfa/page: 320



U-PVC/UH-PVC ÜRÜN GRUBU PRODUCT LINE - SAYFA PAGE: 29-108



U-PVC/UH-PVC VANA ÜRÜN GRUBU VALVE PRODUCT LINE - SAYFA PAGE: 109-160



HDPE ÜRÜN GRUBU PRODUCT LINE - SAYFA PAGE: 161-210



PP-B KAPLİN ÜRÜN GRUBU COMPRESSION PRODUCT LINE - SAYFA PAGE: 211-242



PP/PPRC ÜRÜN GRUBU PRODUCT LINE - SAYFA PAGE: 279-322

PİMTAŞ A.Ş. 1977 yılında kurulmuş olup, üretime başladığı andan itibaren plastik inşaat malzemelerinin (Boru, Ek parça, Küresel Vana, Kelebek Vana, Çekvalf, Rakor, Havuz ve Tesisat teknik ekipmanları) kendine özgü tasarımını ve imalatını yapan, plastik sektöründeki uluslararası öncü kuruluşlardan biridir.

PİMTAŞ A.Ş. kullanmış olduğu üretim teknolojisini geliştirerek mevcut üretimini Batı Avrupa' da kullanılan teknoloji normlarına uyarlamıştır. Üretim programı her türlü inşaat problemini çözecek ek parça ve yardımcı malzemelerini kapsamaktadır. Avrupa ve Gümrük Birliğine geçmiş olmanın bilinci ile teknoloji ve kalitede Avrupa'nın en iyi firmaları ile rekabet eden bir üretim gerçekleştirmektedir.

Bugün Pimtaş Plastik , ISO 9001 kalite yönetim sistemine ve TSE Belgesine sahip olarak en yeni teknolojik altyapı, makine ve kalıp sistemleri ile başta Avrupa ülkeleri başta olmak üzere 105 ayrı ülkeye ihracat yapan ve 81 ilde tüketicinin memnuniyetini ve güvenini kazanmış bir firmadır.

550'yi aşkın tecrübeli çalışanı ile 7/24 hizmet vermektedir. 1977 yılından beri siz değerli müşterilerimize daha kaliteli ürünler ve hizmetler sunabilmek için üretiyor ve her geçen yıl kendini yenilemeye devam ediyor.

Vizyonumuz

Sürekli gelişim hedefi ile sektöründe bir dünya şirketi olmak.

Misyonumuz

Biz, ürettiğimiz ürünlerle insan medeniyetinin alt yapısına hizmet ediyoruz.

Yeryüzünde İnsan hayatına suyun rahat, güvenilir ve standartlara uygun bir şekilde ulaşmasını sağlıyoruz. Ürettiğimiz ürünlerle, insanların temel ihtiyaçlarının karşılanmasından, kaliteli ve konforlu bir yaşamın oluşmasına ve sürdürülmesine kadar tüm yaşam alanlarına destek oluyoruz.

Tarım, Turizm, İnşaat ve altyapı sektörlerindeki müşterilerimizin bize duyduğu güvene; kaliteli, hızlı ve ulaşılabilir plastik boru ve bağlantı ekipmanları üreterek cevap veriyoruz.

PİMTAŞ A.Ş. was established in 1977, and is now one of the leading international companies in the plastic sector that has been designing and manufacturing plastic construction materials (Pipes,Fittings, Ball Valves, Butterfly Valves, Check Valves, Fittings, Pool and Plumbing technical equipment) since the moment it started production.

PİMTAŞ A.Ş. has adapted its current production to the technology standards used in Western Europe by improving its production technology. The production program includes additional parts and auxiliary materials that can solve all kinds of construction problems. With the awareness of being transferred to Europe and the Customs Union, it realizes a production that competes with Europe's best companies in technology and quality.

Today, Pimtaş Plastik is a company that has ISO 9001 quality management system and TSE Certificate and exports to 105 different countries, mostly to European countries, with the latest technological infrastructure, machinery and mold systems, and gained the satisfaction and trust of consumers in 81 provinces.Pimtaş provides 24/7 service with the help of more than 550 experienced employees. It has been producing since 1977 to provide better quality products and services to our valued customers and continues to renew itself every year.

Our Vision

To become a globally known company in its sector with the scope of continuous development.

Our Mission

We serve the infrastructure of human civilization with the products we produce.We ensure that water reaches human life comfortably, reliably and in accordance with the standards. With the products we produce, we support all living spaces, from meeting basic needs to the creation and maintenance of a qualified and comfortable life.

We maintain the confidence of our customers in the agriculture, tourism, construction and infrastructure sectors by producing high quality, fast and accessible plastic pipes and connection equipment.

PİMTAŞ 1



PİMTAŞ 2



PİMTAŞ 3



PİMTAŞ 4



PİMTAŞ 5



PİMTAŞ 6



PİMTAŞ 7



PİMTAŞ 8





KİMYASALLARA DAYANIM RESISTANCE TO CHEMICALS

U-PVC BORULARIN KİMYASAL MADDELERE DAYANIM TABLOSU

TABLE FOR RESISTANCE OF U-PVC PIPES TO CHEMICAL SUBSTANCES

Aşağıdaki tablo'dan da görüleceği üzere, U-PVC Borular bir çok kimyasal ve hemen hemen bütün asitlere karşı çok iyi dayanıma sahiptir. Aşağıdaki tabloda verilen dayanıklılık bilgileri 20°C sıcaklıkta geçerlidir. U-PVC borular, daha yüksek sıcaklıklarda daha değişik davranış gösterebilir. U-PVC boruların diğer kimyasallara karşı ve daha yüksek sıcaklıklardaki dayanıklılık durumları hakkındaki bilgileri firmamızdan temin edebilirsiniz.

As can be seen from the following table, U-PVC pipes have very good strength against many chemicals and almost all acids. Strength information provided in the following table is valid at 20°C temperature. U-PVC pipes may exhibit more different behaviors under higher temperatures. You can obtain detailed information about the strength status of U-PVC pipes against other chemicals and at higher temperatures from our company.

Kimyasalın Adı Name of Chemical	20°C'de Kullanım için Usage at 20°C	40°C'de Kullanım için Usage at 40°C
Anilin	Dayanısız (Irresistant) 😞	Dayanısız (Irresistant) 😞
Arsenic Asit (Up To %80 Conc.)	Dayanıklı (Resistant) 😊	Dayanıklı (Resistant) 😊
Aseton	Dayanısız (Irresistant) 😞	Dayanısız (Irresistant) 😞
Barium Salts (Saturated)	Dayanıklı (Resistant) 😊	Dayanıklı (Resistant) 😊
Beer (Commercial form)	Dayanıklı (Resistant) 😊	
Benzoic Acid	Dayanıklı (Resistant) 😊	Dayanıklı (Resistant) 😊
Gasoline (Fuel)	Dayanıklı (Resistant) 😊	Dayanıklı (Resistant) 😊
Borax (Ageous)	Dayanıklı (Resistant) 😊	Dayanıklı (Resistant) 😊
Boric Acid (Ageous)	Dayanıklı (Resistant) 😊	Dayanıklı (Resistant) 😊
Butanol	Dayanıklı (Resistant) 😊	Dayanıklı (Resistant) 😊
Calcium Hydroxide (Sturated)	Dayanıklı (Resistant) 😊	Dayanıklı (Resistant) 😊
Calcium Salts	Dayanıklı (Resistant) 😊	Dayanıklı (Resistant) 😊
Carbonic Acid	Dayanıklı (Resistant) 😊	Dayanıklı (Resistant) 😊
Caustic Soda (NaOH) (50% Conc.)	Dayanıklı (Resistant) 😊	Dayanıklı (Resistant) 😊
Citric Acid	Dayanıklı (Resistant) 😊	Dayanıklı (Resistant) 😊
Chloric Acid (Up To %20 Conc.)	Dayanıklı (Resistant) 😊	Dayanıklı (Resistant) 😊
Chlorine Gas	Dayanısız (Irresistant) 😞	
Chloroform	Dayanısız (Irresistant) 😞	
Compressed Air With Oil	Dayanısız (Irresistant) 😞	Dayanısız (Irresistant) 😞
Copper Salts	Dayanıklı (Resistant) 😊	Dayanıklı (Resistant) 😊
Diesel Feul (Commercial Form)	Dayanıklı (Resistant) 😊	Dayanıklı (Resistant) 😊
Ethyl Alcohol (%96 Conc.)	Dayanıklı (Resistant) 😊	Dayanıklı (Resistant) 😊
Formic Acid (Up To %50 Aqueous Conc.)	Dayanıklı (Resistant) 😊	Dayanıklı (Resistant) 😊
Freon 12 Gas	Dayanıklı (Resistant) 😊	
Fruit Juice	Dayanıklı (Resistant) 😊	Dayanıklı (Resistant) 😊
Fuel Oil	Dayanıklı (Resistant) 😊	Dayanıklı (Resistant) 😊
Glucose	Dayanıklı (Resistant) 😊	Dayanıklı (Resistant) 😊
Hexane	Dayanıklı (Resistant) 😊	Dayanıklı (Resistant) 😊
Hydrochloric Acid (Up To %38 Aqueous Conc.)	Dayanıklı (Resistant) 😊	Dayanıklı (Resistant) 😊

U-PVC BORULARIN ASİT DAYANIMLARI / RESISTANCE OF U-PVC PIPES TO ACIDS	
Medium	Up to 5 concentration
Sulphuric Acid	≤ 70 % H2SO4
Chromic-Sulphuric acid mixture Chromic Acid	≤ 70 % H2SO4 + K2Cr207 / Na2Cr201 ≤ 10 % CrO3
Hydrochloric Acid	≤ 25% HCl
Nidric Acid	≤ 20 % HNO3 ≤ 6 % HaOCI
Sodium hypochlorite (potassium hypochlorite)	
Hydrogen peroxide	≤ 5 % H2O2
Hydrofluoric Acid	≤ 0 % HF

Kimyasalın Adı Name of Chemical	20°C'de Kullanım için Usage at 20°C	40°C'de Kullanım için Usage at 40°C
Hydrogen Peroxide (Up To 90 % Conc.)	Dayanıklı (Resistant) 😊	
Lactic Acid (% 10 Aqueous Conc)	Dayanıklı (Resistant) 😊	Sınırlı Dayanıklı (Medum Resistant) 😞
Methane - Doğal Gaz (Natural Gas)	Dayanıklı (Resistant) 😊	
Methanol	Dayanıklı (Resistant) 😊	Dayanıklı (Resistant) 😊
Milk (Süt)	Dayanıklı (Resistant) 😊	Dayanıklı (Resistant) 😊
Mineral Water (Maden Suyu)	Dayanıklı (Resistant) 😊	Dayanıklı (Resistant) 😊
Naphtaline	Dayanısız (Irresistant) 😞	
Nitric Acid (HNO3) (% 6,3 Aqueous Conc.)	Dayanıklı (Resistant) 😊	Dayanıklı (Resistant) 😊
Nitric Acid (HNO3) (% 25 Aqueous Conc.)	Dayanıklı (Resistant) 😊	Dayanıklı (Resistant) 😊
Nitric Acid (HNO3) (% 65 Aqueous Conc.)	Sınırlı Dayanıklı (Medum Resistant) 😞	Sınırlı Dayanıklı (Medum Resistant) 😞
Nitric Acid (HNO3) (More Than % 85 Aqueous Conc.)	Dayanısız (Irresistant) 😞	
Olive Oil	Dayanıklı (Resistant) 😊	Dayanıklı (Resistant) 😊
Phosphoric Acid (Up To % 95 Aqueous Conc.)	Dayanıklı (Resistant) 😊	Dayanıklı (Resistant) 😊
Phthalic Acid (Saturated)	Dayanıklı (Resistant) 😊	Sınırlı Dayanıklı (Medum Resistant) 😞
Potassium Hydroxide (% 50 Aqueous Conc.)	Dayanıklı (Resistant) 😊	Dayanıklı (Resistant) 😊
Propane (Gaseous And Liquid)	Dayanıklı (Resistant) 😊	
Salisilic Acid (Saturated)	Dayanıklı (Resistant) 😊	Dayanıklı (Resistant) 😊
Sea Water	Dayanıklı (Resistant) 😊	Dayanıklı (Resistant) 😊
Starch (Nişasta) (Aqueous Solution)	Dayanıklı (Resistant) 😊	Dayanıklı (Resistant) 😊
Sulphuric Acid (Up To % 98 Aqueous Conc.)	Dayanıklı (Resistant) 😊	Dayanıklı (Resistant) 😊
Toluene	Dayanısız (Irresistant) 😞	
Urea (Up To % 30 Conc.)	Dayanıklı (Resistant) 😊	Dayanıklı (Resistant) 😊
Urine	Dayanıklı (Resistant) 😊	Dayanıklı (Resistant) 😊
Xylene	Dayanısız (Irresistant) 😞	

KISALTMALAR LİSTESİ LIST OF ABBREVIATIONS

ANSI	American National Standard
ASTM	American Society for Testing and Materials
BS	British Standard
DIN	Deutsche Industrie-Normen
ISO	International Standardization Organisation
ABS	Acrylnitril Butadien Styrene
PVC-U	Polyvinyl Chloride
PVC- U	Polyvinyl Chloride chlorinated
PP	Polypropylene heat stabilised
PE	Polyethylene
PVDF	Polyvinylidene fluoride
EPDM	Ethylene Propylene Rubber
FPM	Fluorine Rubber. e.g. Viton
NBR	Nitrile Rubber
IIR	Butyl Rubber
CSM	Chlore Sulphonyl Polythene. e.g. Hypalon
CR	Chloroprene Rubber. e.g. Neoprene
PTFE	Polytetrafluorethylene. e.g. Teflon
PB TP	Polybutylene lerephthalate
UP-GF	Unsaturated colyester resin glassfiare reinforced
St	Steel
Ms	Brass
Tg	Malleable iron
d	Pipe outside diameter
DN	Nominal bore
PN	Nominal pressure at 20°C. water
kg	Weight in kilograms
SP	Standard pack.
G	Pipe thread. not pressure tight in the thread to Iso 228-1
NPT	Taper male thread pressure tight in the thread to ANSI B 1.20.1
R	Taper male thread. pressure tight in the thread to ISO7-1/DIN 2999-1
Rc	Taper female thread. pressure tight in the thread to ISO 7-1/DIN 2999-1
Rp	Parallel female thread. pressure tight in the thread to ISO7-1/DIN 2999-1 Trapezoid thread
Tr	Trapezoid thread
SC	Size of hexagon bolts
s	A/F
e	Wall thickness
AL	Number of bolt haies
®	Registered trade-mark
①	Call for price

U-PVC BORULAR PIPES

ÜRETİM STANDARDI
PRODUCTION STANDARD | EN 1452-2

ÇAP / SIZE Ø20 - Ø400



 **PIMTAŞ®**

Since 1977

U-PVC Geçme Mufllu Borular

Pipe With O-Ring (Gasket Socketed)

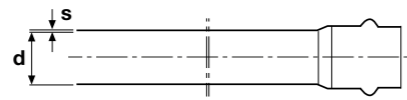

PN 4

Çap Dia	Basınç PN	Kod / Code 6 m	Fiyat (metre) Price (meter)	Ağırlık (Kg/m) Weight (Kg/m)	S(mm) Et kalınlığı Wall Thickness
Emniyet kat sayısı (safety factor) C =2,5					
75	4	101 04 075 1	3,78 €	0.655	1,8
90	4	101 04 090 1	4,58 €	0.790	1,8
Emniyet kat sayısı (safety factor) C =2,0					
110	4	101 04 110 1	6,69 €	1.161	2,2
125	4	101 04 125 1	8,66 €	1.500	2,5
140	4	101 04 140 1	10,88 €	1.882	2,8
160	4	101 04 160 1	14,07 €	2.437	3,2
200	4	101 04 200 1	21,95 €	3.801	4,0
225	4	101 04 225 3	27,80 €	4.811	4,5
250	4	101 04 250 3	33,65 €	5.827	4,9
280	4	101 04 280 3	42,29 €	7.323	5,5
315	4	101 04 315 3	53,54 €	9.272	6,2
355	4	101 04 355 3	68,30 €	11.826	7,0
400	4	101 04 400 3	87,35 €	15.128	7,9
450	4	101 04 450 3	①	20.643	8,9
500	4	101 04 500 3	①	24.083	9,8

PN 6

Çap Dia	Basınç PN	Kod / Code 6 m	Fiyat (metre) Price (meter)	Ağırlık (Kg/m) Unit Weight (Kg/m)	S(mm) Et kalınlığı Wall Thickness
Emniyet kat sayısı (safety factor) C =2,5					
50	6	101 06 050 1	2,12 €	0,369	1,6
63	6	101 06 063 1	3,32 €	0,578	2,0
75	6	101 06 075 1	4,61 €	0,798	2,3
90	6	101 06 090 1	6,66 €	1,150	2,8
Emniyet kat sayısı (safety factor) C =2,0					
110	6	101 06 110 1	7,94 €	1,436	2,7
125	6	101 06 125 1	10,29 €	1,868	3,1
140	6	101 06 140 1	12,81 €	2,362	3,5
160	6	101 06 160 1	16,67 €	3,080	4,0
200	6	101 06 200 1	25,76 €	4,722	4,9
225	6	101 06 225 3	32,73 €	5,970	5,5
250	6	101 06 250 3	40,31 €	7,484	6,2
280	6	101 06 280 3	50,63 €	9,316	6,9
315	6	101 06 315 3	63,99 €	11,739	7,7
355	6	101 06 355 3	81,95 €	14,926	8,7
400	6	101 06 400 3	103,62 €	19,085	9,8
450	6	101 06 450 3	①	24,158	11,0
500	6	101 06 500 3	①	30,072	12,3

Fiyatlara conta dahil değildir. Gasket is not included the price
Miktar yeterli olması durumunda özel boylarda üretim yapılabilir. If the quantity is sufficient, special lengths can be produced.

U-PVC Geçme Mufllu Borular

Pipe With O-Ring (Gasket Socketed)

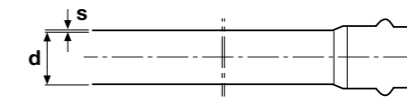

PN 10

Çap Dia	Basınç PN	Kod / Code 6 m	Fiyat (metre) Price (meter)	Ağırlık (Kg/m) Weight (Kg/m)	S(mm) Et kalınlığı Wall Thickness
Emniyet kat sayısı (safety factor) C =2,5					
50	10	101 10 050 1	3,24 €	0,561	2,4
63	10	101 10 063 1	5,10 €	0,879	3,0
75	10	101 10 075 1	7,23 €	1,251	3,6
90	10	101 10 090 1	10,41 €	1,803	4,3
Emniyet kat sayısı (safety factor) C =2,0					
110	10	101 10 110 1	12,68 €	2,193	4,2
125	10	101 10 125 1	16,32 €	2,826	4,8
140	10	101 10 140 1	20,64 €	3,575	5,4
160	10	101 10 160 1	27,27 €	4,691	6,2
200	10	101 10 200 1	42,00 €	7,270	7,7
225	10	101 10 225 3	52,88 €	9,158	8,6
250	10	101 10 250 3	65,73 €	11,379	9,6
280	10	101 10 280 3	82,61 €	14,304	10,7
315	10	101 10 315 3	104,73 €	18,120	12,1
355	10	101 10 355 3	132,39 €	22,926	13,6
400	10	101 10 400 3	169,29 €	29,314	15,3
450	10	101 10 450 3	①	32,052	17,2
500	10	101 10 500 3	①	45,840	19,1

PN 16

Çap Dia	Basınç PN	Kod / Code 6 m	Fiyat (metre) Price (meter)	Ağırlık (Kg/m) Unit Weight (Kg/m)	S(mm) Et kalınlığı Wall Thickness
Emniyet kat sayısı (safety factor) C =2,5					
50	16	101 16 050 1	4,76 €	0,823	3,7
63	16	101 16 063 1	7,61 €	1,317	4,7
75	16	101 16 075 1	10,86 €	1,880	5,6
90	16	101 16 090 1	15,56 €	2,693	6,7
Emniyet kat sayısı (safety factor) C =2,0					
110	16	101 16 110 1	19,16 €	3,318	6,6
125	16	101 16 125 1	24,45 €	4,235	7,4
140	16	101 16 140 1	30,80 €	5,330	8,3
160	16	101 16 160 1	40,23 €	6,965	9,5
200	16	101 16 200 1	63,03 €	10,914	11,9
225	16	101 16 225 3	80,16 €	13,881	13,4
250	16	101 16 250 3	98,54 €	17,062	14,8
280	16	101 16 280 3	123,74 €	21,424	16,6
315	16	101 16 315 3	157,41 €	27,257	18,7
355	16	101 16 355 3	200,28 €	34,680	21,1
400	16	101 16 400 3	258,00 €	44,676	23,7
450	16	101 16 450 3	①		
500	16	101 16 500 3	①		

Fiyatlara conta dahil değildir. Gasket is not included the price
Miktar yeterli olması durumunda özel boylarda üretim yapılabilir. If the quantity is sufficient, special lengths can be produced.

U-PVC Yapıştırma Mufllu Borular

U-PVC Solvent Cement Socketed Pressure Pipes

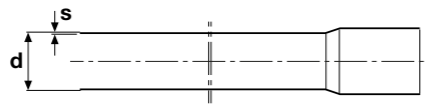

PN 4

Çap Dia	Basınç PN	Kod / Code 6 m	Kod / Code 3 m	Fiyat (metre) Price (meter)	Ağırlık (Kg/m) Weight (Kg/m)	S(mm) Et kalınlığı Wall Thickness
Emniyet kat sayısı (safety factor) C =2,5						
75	4	100 04 075 1	150 04 075 1	3,78 €	0,655	1,8
90	4	100 04 090 1	150 04 090 1	4,58 €	0,790	1,8
Emniyet kat sayısı (safety factor) C =2,0						
110	4	100 04 110 1	150 04 110 1	6,71 €	1,161	2,2
125	4	100 04 125 1	150 04 125 1	8,66 €	1,500	2,5
140	4	100 04 140 1	150 04 140 1	10,53 €	1,822	2,8
160	4	100 04 160 1	150 04 160 1	14,10 €	2,437	3,2
200	4	100 04 200 1	150 04 200 1	21,95 €	3,801	4,0
225	4	100 04 225 3	150 04 225 3	27,80 €	4,811	4,5
250	4	100 04 250 3	150 04 250 3	33,65 €	5,827	4,9
280	4	100 04 280 3	150 04 280 3	42,27 €	7,321	5,5
315	4	100 04 315 3	150 04 315 3	53,54 €	9,272	6,2
355	4	100 04 355 3	150 04 355 3	68,30 €	11,826	7,0
400	4	100 04 400 3	150 04 400 3	87,02 €	15,069	7,9
450	4	100 04 450 3	150 04 450 3	①	20,900	8,9
500	4	100 04 500 3	150 04 500 3	①	24,100	9,8

PN 6

Çap Dia	Basınç PN	Kod / Code 6 m	Kod / Code 3 m	Fiyat (metre) Price (meter)	Ağırlık (Kg/m) Weight (Kg/m)	S(mm) Et kalınlığı Wall Thickness
Emniyet kat sayısı (safety factor) C =2,5						
50	6	100 06 050 1	150 06 050 1	2,12 €	0,367	1,6
63	6	100 06 063 1	150 06 063 1	3,32 €	0,574	2,0
75	6	100 06 075 1	150 06 075 1	4,61 €	0,798	2,3
90	6	100 06 090 1	150 06 090 1	6,66 €	1,154	2,8
Emniyet kat sayısı (safety factor) C =2,0						
110	6	100 06 110 1	150 06 110 1	7,94 €	1,375	2,7
125	6	100 06 125 1	150 06 125 1	10,29 €	1,783	3,1
140	6	100 06 140 1	150 06 140 1	12,81 €	2,216	3,5
160	6	100 06 160 1	150 06 160 1	16,67 €	2,887	4,0
200	6	100 06 200 1	150 06 200 1	25,76 €	4,459	4,9
225	6	100 06 225 3	150 06 225 3	32,73 €	5,669	5,5
250	6	100 06 250 3	150 06 250 3	40,31 €	6,979	6,2
280	6	100 06 280 3	150 06 280 3	50,63 €	8,766	6,9
315	6	100 06 315 3	150 06 315 3	63,99 €	11,081	7,7
355	6	100 06 355 3	150 06 355 3	81,95 €	14,189	8,7
400	6	100 06 400 3	150 06 400 3	103,62 €	17,943	9,8
450	6	100 06 450 3	150 06 450 3	①	23,119	11,0
500	6	100 06 500 3	150 06 500 3	①	28,720	12,3

Miktar yeterli olması durumunda özel boylarda üretim yapılabilir. If the quantity is sufficient, special lengths can be produced.

U-PVC Yapıştırma Mufllu Borular

U-PVC Solvent Cement Socketed Pressure Pipes

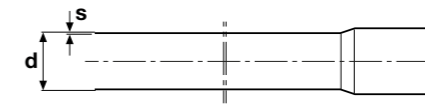

PN 10

Çap Dia	Basınç PN	Kod / Code 6 m	Kod / Code 3 m	Fiyat (metre) Price (meter)	Ağırlık (Kg/m) Weight (Kg/m)	S(mm) Et kalınlığı Wall Thickness
Emniyet kat sayısı (safety factor) C =2,5						
25	10	100 10 025 1	150 10 025 1	0,96 €	0,165	1,5
32	10	100 10 032 1	150 10 032 1	1,40 €	0,241	1,6
40	10	100 10 040 1	150 10 040 1	2,04 €	0,353	1,9
50	10	100 10 050 1	150 10 050 1	3,24 €	0,561	2,4
63	10	100 10 063 1	150 10 063 1	5,03 €	0,871	3,0
75	10	100 10 075 1	150 10 075 1	7,20 €	1,245	3,6
90	10	100 10 090 1	150 10 090 1	10,29 €	1,784	4,3
Emniyet kat sayısı (safety factor) C =2,0						
110	10	100 10 110 1	150 10 110 1	12,48 €	2,160	4,2
125	10	100 10 125 1	150 10 125 1	16,08 €	2,782	4,8
140	10	100 10 140 1	150 10 140 1	20,28 €	3,512	5,4
160	10	100 10 160 1	150 10 160 1	26,60 €	4,607	6,2
200	10	100 10 200 1	150 10 200 1	41,13 €	7,123	7,7
225	10	100 10 225 3	150 10 225 3	51,72 €	8,957	8,6
250	10	100 10 250 3	150 10 250 3	64,22 €	11,119	9,6
280	10	100 10 280 3	150 10 280 3	80,88 €	14,007	10,7
315	10	100 10 315 3	150 10 315 3	100,50 €	17,404	12,1
355	10	100 10 355 3	150 10 355 3	128,04 €	22,171	13,6
400	10	100 10 400 3	150 10 400 3	161,78 €	28,014	15,3
450	10	100 10 450 3	150 10 450 3	①	35,640	17,2
500	10	100 10 500 3	150 10 500 3	①	43,976	19,1

PN 16

Çap Dia	Basınç PN	Kod / Code 6 m	Kod / Code 3 m	Fiyat (metre) Price (meter)	Ağırlık (Kg/m) Weight (Kg/m)	S(mm) Et kalınlığı Wall Thickness
Emniyet kat sayısı (safety factor) C =2,5						
20	16	100 16 020 1	150 16 020 1	0,78 €	0,138	1,5
25	16	100 16 025 1	150 16 025 1	1,25 €	0,213	1,9
32	16	100 16 032 1	150 16 032 1	2,00 €	0,345	2,4
40	16	100 16 040 1	150 16 040 1	3,08 €	0,530	3,0
50	16	100 16 050 1	150 16 050 1	4,76 €	0,823	3,7
63	16	100 16 063 1	150 16 063 1	7,59 €	1,313	4,7
75	16	100 16 075 1	150 16 075 1	10,74 €	1,860	5,6
90	16	100 16 090 1	150 16 090 1	15,38 €	2,663	6,7
Emniyet kat sayısı (safety factor) C =2,0						
110	16	100 16 110 1	150 16 110 1	18,87 €	3,268	6,6
125	16	100 16 125 1	150 16 125 1	24,08 €	4,169	7,4
140	16	100 16 140 1	150 16 140 1	30,24 €	5,237	8,3
160	16	100 16 160 1	150 16 160 1	39,50 €	6,839	9,5
200	16	100 16 200 1	150 16 200 1	61,31 €	10,616	11,9
225	16	100 16 225 3	150 16 225 3	77,61 €	13,441	13,4
250	16	100 16 250 3	150 16 250 3	95,43 €	16,524	14,8
280	16	100 16 280 3	150 16 280 3	120,21 €	20,424	16,6
315	16	100 16 315 3	150 16 315 3	152,00 €	26,815	18,7
355	16	100 16 355 3	150 16 355 3	194,24 €	33,635	21,1
400	16	100 16 400 3	150 16 400 3	247,25 €	42,812	23,7
450	16	100 16 450 3	150 16 450 3	①		
500	16	100 16 500 3	150 16 500 3	①		

Miktar yeterli olması durumunda özel boylarda üretim yapılabilir. If the quantity is sufficient, special lengths can be produced.

U-PVC Zonder Boru

U-PVC Industry Pipes

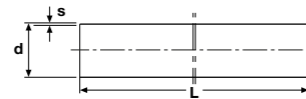

PN 20

Çap Dia	Basınç PN	Kod /Code 3 m	Fiyat (metre) Price (meter)	Birim ağırlık (Kg/m) Unit Weight (Kg/m)	S (mm) Et kalınlığı Wall Thickness
Emniyet kat sayısı (safety factor) C =2,5					
20	20	102 20 020 1	1,28 €	0,170	1,9
25	20	102 20 025 1	1,94 €	0,270	2,3
32	20	102 20 032 1	2,93 €	0,410	2,9
40	20	102 20 040 1	4,58 €	0,650	3,7
50	20	102 20 050 1	6,84 €	1,005	4,6
63	20	102 20 063 1	11,10 €	1,590	5,8
75	20	102 20 075 1	15,45 €	2,216	6,8
90	20	102 20 090 1	22,44 €	3,205	8,2
Emniyet kat sayısı (safety factor) C =2,0					
110	20	102 20 110 1	27,75 €	3,995	8,1
125	20	102 20 125 1	35,25 €	5,105	8,7
140	20	102 20 140 1	44,70 €	6,384	9,2
160	20	102 20 160 1	50,40 €	7,340	11,8
200	20	102 20 200 1	89,25 €	13,050	14,7

PN 25

Çap Dia	Basınç PN	Kod /Code 3 m	Fiyat (metre) Price (meter)	Birim ağırlık (Kg/m) Unit Weight (Kg/m)	S(mm) Et kalınlığı Wall Thickness
Emniyet kat sayısı (safety factor) C =2,5					
20	25	102 25 020 1	1,44 €	0,195	2,3
25	25	102 25 025 1	2,13 €	0,299	2,8
32	25	102 25 032 1	3,48 €	0,490	3,6
40	25	102 25 040 1	5,63 €	0,810	4,5
50	25	102 25 050 1	8,07 €	1,190	5,6
63	25	102 25 063 1	13,14 €	1,900	7,1
75	25	102 25 075 1	18,50 €	2,678	8,4
90	25	102 25 090 1	26,54 €	3,830	10,0
Emniyet kat sayısı (safety factor) C =2,0					
110	25	102 25 110 1	33,00 €	4,788	10,0
125	25	102 25 125 1	42,48 €	6,200	11,4
140	25	102 25 140 1	53,30 €	7,685	12,6
160	25	102 25 160 1	69,03 €	10,163	14,6
200	25	102 25 200 1	107,07 €	15,750	18,2

U-PVC Şeffaf Boru

U-PVC Transparent Pipe



Çap Dia	Basınç PN	Kod / Code 5 m	Fiyat (metre) Price (meter)	(Kg/m) (Kg/m)	S (mm) Et kalınlığı Wall Thickness
20	10	231 020 0208	9,02 €	0,137	1,5
25	10	231 020 0258	12,33 €	0,174	1,5
32	10	231 020 0328	14,12 €	0,264	1,8
40	10	231 020 0408	20,88 €	0,366	2,0
50	10	231 020 0508	25,43 €	0,552	2,4
63	10	231 020 0638	67,65 €	0,854	3,0
75	10	231 020 0758	68,31 €	1,220	3,6
90	10	231 020 0908	97,22 €	1,750	4,3
110	10	231 020 1108	142,32 €	2,610	5,3
125	10	231 020 1258	168,00 €		
140	10	231 020 1408	Ⓜ		
160	10	231 020 1608	Ⓜ		
200	10	231 020 2008	Ⓜ		

U-PVC Özel Amaçlı Borular

U-PVC Specific Usage Pipes

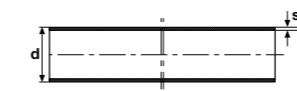

Çap Dia	Kod / Code 3 m	Fiyat (metre) Price (meter)	(Kg/m) (Kg/m)	S (mm) Et kalınlığı Wall Thickness
8	121 15 008 1	1,82 €	0,047	1,5
9	121 15 009 1	1,85 €	0,055	1,5
10	121 15 010 1	1,86 €	0,061	1,5
10	121 20 010 1	1,86 €	0,043	1,0
11	121 15 011 1	1,88 €	0,068	1,5
12	121 15 012 1	1,89 €	0,075	1,5
12	121 20 012 1	1,89 €	0,096	2,0
14	121 20 014 1	1,91 €	0,115	2,0
16	121 20 016 1	1,92 €	0,134	2,0
17	121 10 017 1	1,94 €	0,077	1,0
17	121 15 017 1	1,94 €	0,111	1,5
18	121 15 018 1	1,95 €	0,119	1,5
20	121 10 020 1	1,95 €	0,092	1,0
20	121 15 020 1	1,98 €	0,133	1,5
20	121 20 020 1	2,01 €	0,173	2,0
21	121 20 021 1	2,01 €	0,182	2,0
22	121 25 022 1	2,04 €	0,233	2,5
23	121 10 023 1	2,04 €	0,107	1,0
27	121 20 027 1	2,07 €	0,239	2,0
32	121 15 032 1	2,85 €	0,219	1,5
33	121 20 033 1	3,63 €	0,297	2,0
40	121 20 040 1	4,13 €	0,364	2,0
42	121 20 042 1	4,79 €	0,383	2,0
50	121 20 050 1	6,60 €	0,460	2,0
63	121 20 063 1	16,50 €	0,584	2,0

Not / Note

U-PVC

DEVE BOYNU BORULAR LONG BEND PIPES

ÜRETİM STANDARDI
PRODUCTION STANDARD | EN 1452-2

ÇAP / SIZE Ø25 - Ø500



U-PVC Geçme Mufllu Temiz Su Deve Boynu

U-PVC Long Bend With O-Ring Socket

11° PN 10

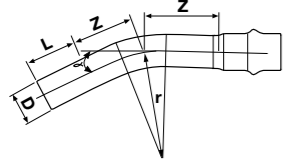

Çap Dia	Basınç PN	Kod Code	Fiyat (Adet) Price (Pcs)	Açılış Açısı	Yarıçap R	Z mm	L mm
Emniyet kat sayısı (safety factor) C =2,5							
50	10	111 10 050 6	4,86 €	11°	125	62	86
63	10	111 10 063 6	6,95 €	11°	221	46	90
75	10	111 10 075 6	10,47 €	11°	263	55	94
90	10	111 10 090 6	16,71 €	11°	315	66	97
Emniyet kat sayısı (safety factor) C =2,0							
110	10	111 10 110 6	23,76 €	11°	385	81	104
125	10	111 10 125 6	30,57 €	11°	438	92	108
140	10	111 10 140 6	42,06 €	11°	490	103	112
160	10	111 10 160 6	59,81 €	11°	560	118	119
200	10	111 10 200 6	113,87 €	11°	700	147	129
225	10	111 10 225 6	160,89 €	11°	788	166	136
250	10	111 10 250 6	235,11 €	11°	875	184	143
280	10	111 10 280 6	350,57 €	11°	980	206	152
315	10	111 10 315 6	462,68 €	11°	1103	232	160
355	10	111 10 355 6	607,28 €	11°	1243	262	169
400	10	111 10 400 6	887,76 €	11°	1400	295	178
450	10	111 10 450 6	①	11°	1575	332	
500	10	111 10 500 6	①	11°	1750	369	

11° PN 16

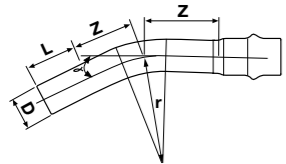

Çap Dia	Basınç PN	Kod Code	Fiyat (Adet) Price (Pcs)	Açılış Açısı	Yarıçap R	Z mm	L mm
Emniyet kat sayısı (safety factor) C =2,5							
50	16	111 16 050 6	7,73 €	11°	125	62	86
63	16	111 16 063 6	11,82 €	11°	221	46	90
75	16	111 16 075 6	19,07 €	11°	263	55	94
90	16	111 16 090 6	30,30 €	11°	315	66	97
Emniyet kat sayısı (safety factor) C =2,0							
110	16	111 16 110 6	40,34 €	11°	385	81	104
125	16	111 16 125 6	51,98 €	11°	438	92	108
140	16	111 16 140 6	71,55 €	11°	490	103	112
160	16	111 16 160 6	101,69 €	11°	560	118	119
200	16	111 16 200 6	193,53 €	11°	700	147	129
225	16	111 16 225 6	273,89 €	11°	788	166	136
250	16	111 16 250 6	399,63 €	11°	875	184	143
280	16	111 16 280 6	596,00 €	11°	980	206	152
315	16	111 16 315 6	786,80 €	11°	1103	232	160
355	16	111 16 355 6	1.032,99 €	11°	1243	262	169
400	16	111 16 400 6	1.509,44 €	11°	1400	295	178
450	16	111 16 450 6	①	11°	1575	332	
500	16	111 16 500 6	①	11°	1750	369	

Fiyatlara conta dahil değildir. Gasket is not included the price

U-PVC Geçme Mufllu Temiz Su Deve Boynu

U-PVC Long Bend With O-Ring Socket

22,5° PN 10

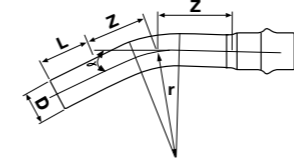

Çap Dia	Basınç PN	Kod Code	Fiyat (Adet) Price (Pcs)	Açılış Açısı	Yarıçap R	Z mm	L mm
Emniyet kat sayısı (safety factor) C =2,5							
50	10	112 10 050 6	4,86 €	22,5°	125	74	86
63	10	112 10 063 6	6,95 €	22,5°	221	68	90
75	10	112 10 075 6	10,47 €	22,5°	263	81	94
90	10	112 10 090 6	16,71 €	22,5°	315	97	97
Emniyet kat sayısı (safety factor) C =2,0							
110	10	112 10 110 6	23,76 €	22,5°	385	119	104
125	10	112 10 125 6	30,57 €	22,5°	438	135	108
140	10	112 10 140 6	42,06 €	22,5°	490	151	112
160	10	112 10 160 6	59,81 €	22,5°	560	173	119
200	10	112 10 200 6	113,87 €	22,5°	700	216	129
225	10	112 10 225 6	160,89 €	22,5°	788	243	136
250	10	112 10 250 6	235,11 €	22,5°	875	270	143
280	10	112 10 280 6	350,57 €	22,5°	980	302	152
315	10	112 10 315 6	462,68 €	22,5°	1103	340	160
355	10	112 10 355 6	607,28 €	22,5°	1243	384	169
400	10	112 10 400 6	887,76 €	22,5°	1400	432	178
450	10	112 10 450 6	①	22,5°	1575	486	
500	10	112 10 500 6	①	22,5°	1750	540	

22,5° PN 16

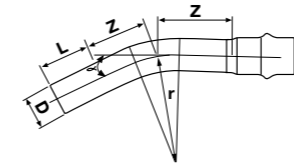

Çap Dia	Basınç PN	Kod Code	Fiyat (Adet) Price (Pcs)	Açılış Açısı	Yarıçap R	Z mm	L mm
Emniyet kat sayısı (safety factor) C =2,5							
50	16	112 16 050 6	7,73 €	22,5°	125	74	86
63	16	112 16 063 6	11,82 €	22,5°	221	68	90
75	16	112 16 075 6	19,07 €	22,5°	263	81	94
90	16	112 16 090 6	30,30 €	22,5°	315	97	97
Emniyet kat sayısı (safety factor) C =2,0							
110	16	112 16 110 6	40,34 €	22,5°	385	119	104
125	16	112 16 125 6	51,98 €	22,5°	438	135	108
140	16	112 16 140 6	71,55 €	22,5°	490	151	112
160	16	112 16 160 6	101,69 €	22,5°	560	173	119
200	16	112 16 200 6	193,53 €	22,5°	700	216	129
225	16	112 16 225 6	273,89 €	22,5°	788	243	136
250	16	112 16 250 6	399,63 €	22,5°	875	270	143
280	16	112 16 280 6	596,00 €	22,5°	980	302	152
315	16	112 16 315 6	786,80 €	22,5°	1103	340	160
355	16	112 16 355 6	1.032,99 €	22,5°	1243	384	169
400	16	112 16 400 6	1.509,44 €	22,5°	1400	432	178
450	16	112 16 450 6	①	22,5°	1575	486	
500	16	112 16 500 6	①	22,5°	1750	540	

Fiyatlara conta dahil değildir. Gasket is not included the price

U-PVC Geçme Mufllu Temiz Su Deve Boynu
U-PVC Long Bend With O-Ring Socket

30° PN 10

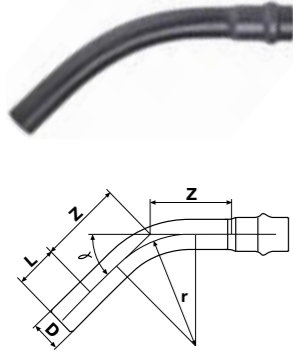

Çap Dia	Basınç PN	Kod Code	Fiyat (Adet) Price (Pcs)	Açı Angle	Yarıçap R	Z mm	L mm
Emniyet kat sayısı (safety factor) C =2,5							
50	10	113 10 050 6	5,54 €	30°	125	84	86
63	10	113 10 063 6	8,04 €	30°	221	84	90
75	10	113 10 075 6	13,61 €	30°	263	100	94
90	10	113 10 090 6	18,93 €	30°	315	120	97
Emniyet kat sayısı (safety factor) C =2,0							
110	10	113 10 110 6	25,04 €	30°	385	147	104
125	10	113 10 125 6	40,26 €	30°	438	167	108
140	10	113 10 140 6	54,47 €	30°	490	187	112
160	10	113 10 160 6	71,09 €	30°	560	214	119
200	10	113 10 200 6	142,19 €	30°	700	268	129
225	10	113 10 225 6	190,41 €	30°	788	301	136
250	10	113 10 250 6	271,17 €	30°	875	334	143
280	10	113 10 280 6	450,20 €	30°	980	375	152
315	10	113 10 315 6	569,13 €	30°	1103	421	160
355	10	113 10 355 6	777,29 €	30°	1243	475	169
400	10	113 10 400 6	1.184,04 €	30°	1400	535	178
450	10	113 10 450 6	Ⓜ	30°	1575	602	
500	10	113 10 500 6	Ⓜ	30°	1750	669	

30° PN 16

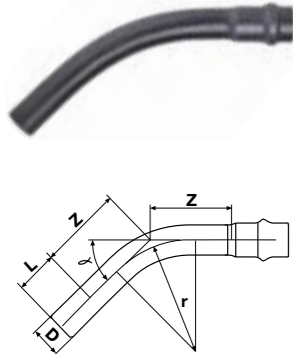

Çap Dia	Basınç PN	Kod Code	Fiyat (Adet) Price (Pcs)	Açı Angle	Yarıçap R	Z mm	L mm
Emniyet kat sayısı (safety factor) C =2,5							
50	16	113 16 050 6	8,48 €	30°	125	84	86
63	16	113 16 063 6	14,28 €	30°	221	84	90
75	16	113 16 075 6	23,15 €	30°	263	100	94
90	16	113 16 090 6	32,24 €	30°	315	120	97
Emniyet kat sayısı (safety factor) C =2,0							
110	16	113 16 110 6	42,47 €	30°	385	147	104
125	16	113 16 125 6	68,39 €	30°	438	167	108
140	16	113 16 140 6	92,72 €	30°	490	187	112
160	16	113 16 160 6	120,62 €	30°	560	214	119
200	16	113 16 200 6	241,17 €	30°	700	268	129
225	16	113 16 225 6	322,52 €	30°	788	301	136
250	16	113 16 250 6	459,63 €	30°	875	334	143
280	16	113 16 280 6	767,73 €	30°	980	375	152
315	16	113 16 315 6	966,77 €	30°	1103	421	160
355	16	113 16 355 6	1.270,25 €	30°	1243	475	169
400	16	113 16 400 6	2.011,89 €	30°	1400	535	178
450	16	113 16 450 6	Ⓜ	30°	1575	602	
500	16	113 16 500 6	Ⓜ	30°	1750	669	

Fiyatlara conta dahil değildir. Gasket is not included the price

U-PVC Geçme Mufllu Temiz Su Deve Boynu
U-PVC Long Bend With O-Ring Socket

45° PN 10

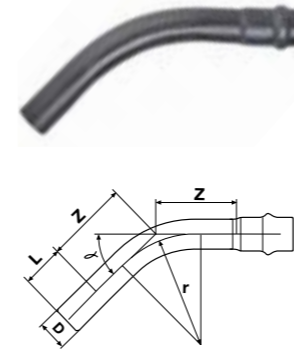

Çap Dia	Basınç PN	Kod Code	Fiyat (Adet) Price (Pcs)	Açı Angle	Yarıçap R	Z mm	L mm
Emniyet kat sayısı (safety factor) C =2,5							
50	10	114 10 050 6	5,54 €	45°	125	102	86
63	10	114 10 063 6	8,04 €	45°	221	117	90
75	10	114 10 075 6	13,61 €	45°	263	139	94
90	10	114 10 090 6	18,93 €	45°	315	166	97
Emniyet kat sayısı (safety factor) C =2,0							
110	10	114 10 110 6	25,04 €	45°	385	203	104
125	10	114 10 125 6	40,26 €	45°	438	231	108
140	10	114 10 140 6	54,47 €	45°	490	259	112
160	10	114 10 160 6	71,09 €	45°	560	296	119
200	10	114 10 200 6	142,19 €	45°	700	370	129
225	10	114 10 225 6	190,41 €	45°	788	416	136
250	10	114 10 250 6	271,17 €	45°	875	462	143
280	10	114 10 280 6	450,20 €	45°	980	518	152
315	10	114 10 315 6	569,13 €	45°	1103	583	160
355	10	114 10 355 6	777,29 €	45°	1243	656	169
400	10	114 10 400 6	1.184,04 €	45°	1400	740	178
450	10	114 10 450 6	Ⓜ	45°	1575	832	
500	10	114 10 500 6	Ⓜ	45°	1750	925	

45° PN 16



Çap Dia	Basınç PN	Kod Code	Fiyat (Adet) Price (Pcs)	Açı Angle	Yarıçap R	Z mm	L mm
Emniyet kat sayısı (safety factor) C =2,5							
50	16	114 16 050 6	8,48 €	45°	125	84	86
63	16	114 16 063 6	14,28 €	45°	221	84	90
75	16	114 16 075 6	23,15 €	45°	263	100	94
90	16	114 16 090 6	32,24 €	45°	315	120	97
Emniyet kat sayısı (safety factor) C =2,0							
110	16	114 16 110 6	42,47 €	45°	385	147	104
125	16	114 16 125 6	68,39 €	45°	438	167	108
140	16	114 16 140 6	92,72 €	45°	490	187	112
160	16	114 16 160 6	120,62 €	45°	560	214	119
200	16	114 16 200 6	241,17 €	45°	700	268	129
225	16	114 16 225 6	322,52 €	45°	788	301	136
250	16	114 16 250 6	459,63 €	45°	875	334	143
280	16	114 16 280 6	767,73 €	45°	980	375	152
315	16	114 16 315 6	966,77 €	45°	1103	421	160
355	16	114 16 355 6	1.270,25 €	45°	1243	475	169
400	16	114 16 400 6	2.011,89 €	45°	1400	535	178
450	16	114 16 450 6	Ⓜ	45°	1575	602	
500	16	114 16 500 6	Ⓜ	45°	1750	669	

Fiyatlara conta dahil değildir. Gasket is not included the price

U-PVC Geçme Mufllu Temiz Su Deve Boynu

U-PVC Long Bend With O-Ring Socket

60° PN 10

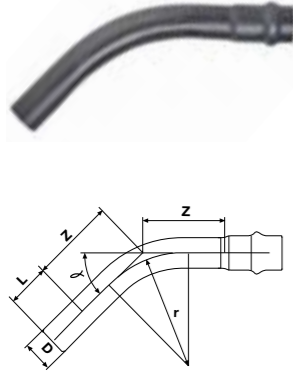

Çap Dia	Basınç PN	Kod Code	Fiyat (Adet) Price (Pcs)	Açı Angle	Yarıçap R	Z mm	L mm
Emniyet kat sayısı (safety factor) C =2,5							
50	10	115 10 050 6	6,18 €	60°	125	122	86
63	10	115 10 063 6	9,26 €	60°	221	153	90
75	10	115 10 075 6	14,72 €	60°	263	182	94
90	10	115 10 090 6	26,00 €	60°	315	218	97
Emniyet kat sayısı (safety factor) C =2,0							
110	10	115 10 110 6	33,35 €	60°	385	266	104
125	10	115 10 125 6	53,13 €	60°	438	303	108
140	10	115 10 140 6	70,26 €	60°	490	339	112
160	10	115 10 160 6	96,39 €	60°	560	387	119
200	10	115 10 200 6	191,13 €	60°	700	484	129
225	10	115 10 225 6	271,16 €	60°	788	545	136
250	10	115 10 250 6	389,13 €	60°	875	605	143
280	10	115 10 280 6	522,72 €	60°	980	678	152
315	10	115 10 315 6	967,04 €	60°	1103	763	160
355	10	115 10 355 6	1.106,43 €	60°	1243	859	169
400	10	115 10 400 6	1.701,75 €	60°	1400	968	178
450	10	115 10 450 6	①	60°	1575	1089	
500	10	115 10 500 6	①	60°	1750	1210	

60° PN 16

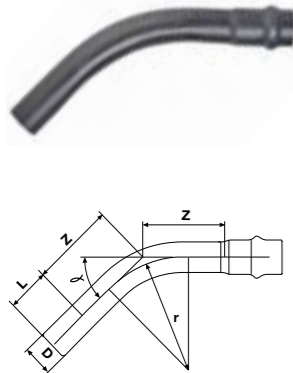

Çap Dia	Basınç PN	Kod Code	Fiyat (Adet) Price (Pcs)	Açı Angle	Yarıçap R	Z mm	L mm
Emniyet kat sayısı (safety factor) C =2,5							
50	16	115 16 050 6	9,12 €	60°	125	122	86
63	16	115 16 063 6	15,74 €	60°	221	153	90
75	16	115 16 075 6	25,04 €	60°	263	182	94
90	16	115 16 090 6	44,15 €	60°	315	218	97
Emniyet kat sayısı (safety factor) C =2,0							
110	16	115 16 110 6	56,73 €	60°	385	266	104
125	16	115 16 125 6	90,29 €	60°	438	303	108
140	16	115 16 140 6	119,45 €	60°	490	339	112
160	16	115 16 160 6	165,00 €	60°	560	387	119
200	16	115 16 200 6	323,43 €	60°	700	484	129
225	16	115 16 225 6	460,65 €	60°	788	545	136
250	16	115 16 250 6	659,21 €	60°	875	605	143
280	16	115 16 280 6	888,63 €	60°	980	678	152
315	16	115 16 315 6	1.643,67 €	60°	1103	763	160
355	16	115 16 355 6	1.887,60 €	60°	1243	859	169
400	16	115 16 400 6	2.892,39 €	60°	1400	968	178
450	16	115 16 450 6	①	60°	1575	1089	
500	16	115 16 500 6	①	60°	1750	1210	

Fiyatlara conta dahil değildir. Gasket is not included the price

U-PVC Geçme Mufllu Temiz Su Deve Boynu

U-PVC Long Bend With O-Ring Socket

90° PN 10

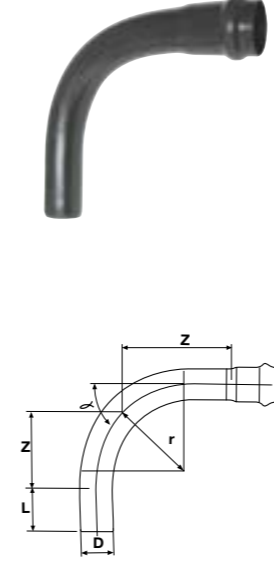

Çap Dia	Basınç PN	Kod Code	Fiyat (Adet) Price (Pcs)	Açı Angle	Yarıçap R	Z mm	L mm
Emniyet kat sayısı (safety factor) C =2,5							
50	10	116 10 050 6	6,18 €	90°	125	175	86
63	10	116 10 063 6	9,26 €	90°	221	246	90
75	10	116 10 075 6	14,72 €	90°	263	293	94
90	10	116 10 090 6	26,00 €	90°	315	351	97
Emniyet kat sayısı (safety factor) C =2,0							
110	10	116 10 110 6	33,35 €	90°	385	429	104
125	10	116 10 125 6	53,13 €	90°	438	488	108
140	10	116 10 140 6	70,26 €	90°	490	546	112
160	10	116 10 160 6	96,39 €	90°	560	624	119
200	10	116 10 200 6	191,13 €	90°	700	780	129
225	10	116 10 225 6	271,16 €	90°	788	878	136
250	10	116 10 250 6	389,13 €	90°	875	975	143
280	10	116 10 280 6	522,72 €	90°	980	1092	152
315	10	116 10 315 6	967,04 €	90°	1103	1229	160
355	10	116 10 355 6	1.106,43 €	90°	1243	1385	169
400	10	116 10 400 6	1.701,75 €	90°	1400	1560	178
450	10	116 10 450 6	①	90°	1575	1755	
500	10	116 10 500 6	①	90°	1750	1950	

90° PN 16

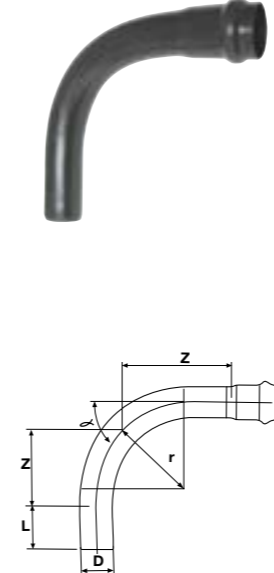

Çap Dia	Basınç PN	Kod Code	Fiyat (Adet) Price (Pcs)	Açı Angle	Yarıçap R	Z mm	L mm
Emniyet kat sayısı (safety factor) C =2,5							
50	16	116 16 050 6	9,12 €	90°	125	122	175
63	16	116 16 063 6	15,74 €	90°	221	153	246
75	16	116 16 075 6	25,04 €	90°	263	182	293
90	16	116 16 090 6	44,15 €	90°	315	218	351
Emniyet kat sayısı (safety factor) C =2,0							
110	16	116 16 110 6	56,73 €	90°	385	266	429
125	16	116 16 125 6	90,29 €	90°	438	303	488
140	16	116 16 140 6	119,45 €	90°	490	339	546
160	16	116 16 160 6	165,00 €	90°	560	387	624
200	16	116 16 200 6	323,43 €	90°	700	484	780
225	16	116 16 225 6	460,65 €	90°	788	545	878
250	16	116 16 250 6	659,21 €	90°	875	605	975
280	16	116 16 280 6	888,63 €	90°	980	678	1092
315	16	116 16 315 6	1.643,67 €	90°	1103	763	1229
355	16	116 16 355 6	1.887,60 €	90°	1243	859	1385
400	16	116 16 400 6	2.892,39 €	90°	1400	968	1560
450	16	116 16 450 6	①	90°	1575	1089	1755
500	16	116 16 500 6	①	90°	1750	1210	1950

Fiyatlara conta dahil değildir. Gasket is not included the price

U-PVC Yapıştırma Muflu Temiz Su Deve Boynu

U-PVC Solvent Cement Socketed Long Bend

11° PN 10

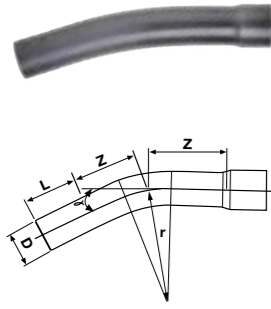

Çap Dia	Basınç (PN)	Kod Code	Fiyat (Adet) Price (Pcs)	Açrı Angle	Yarıçap (r)	Z (mm)	L (mm)
Emniyet kat sayısı (safety factor) C =2,5							
25	10	105 10 025 6	4,86 €	11°	63	31	18,5
32	10	105 10 032 6	4,86 €	11°	80	40	22
40	10	105 10 040 6	4,86 €	11°	100	50	26
50	10	105 10 050 6	4,86 €	11°	125	62	31
63	10	105 10 063 6	6,95 €	11°	221	46	37,5
75	10	105 10 075 6	10,47 €	11°	263	55	43,5
90	10	105 10 090 6	16,71 €	11°	315	66	51
Emniyet kat sayısı (safety factor) C =2,0							
110	10	105 10 110 6	23,73 €	11°	385	81	61
125	10	105 10 125 6	30,57 €	11°	438	92	68,5
140	10	105 10 140 6	42,09 €	11°	490	103	76
160	10	105 10 160 6	59,81 €	11°	560	118	86
200	10	105 10 200 6	113,84 €	11°	700	147	106
225	10	105 10 225 6	160,89 €	11°	788	166	118,5
250	10	105 10 250 6	235,08 €	11°	875	184	131
280	10	105 10 280 6	350,57 €	11°	980	206	146
315	10	105 10 315 6	462,63 €	11°	1103	232	163,5
355	10	105 10 355 6	607,28 €	11°	1243	262	183,5
400	10	105 10 400 6	887,76 €	11°	1400	295	206
450	10	105 10 450 6	①	11°	1575	332	
500	10	105 10 500 6	①				

11° PN 16

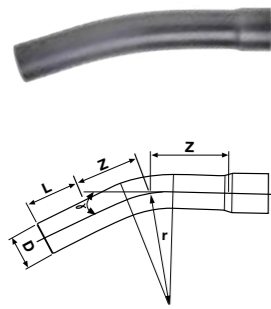

Çap Dia	Basınç (PN)	Kod Code	Fiyat (Adet) Price (Pcs)	Açrı Angle	Yarıçap (R)	Z (mm)	L (mm)
Emniyet kat sayısı (safety factor) C =2,5							
25	16	105 16 025 6	7,70 €	11°	63	31	18,5
32	16	105 16 032 6	7,70 €	11°	80	40	22
40	16	105 16 040 6	7,70 €	11°	100	50	26
50	16	105 16 050 6	7,70 €	11°	125	62	31
63	16	105 16 063 6	11,82 €	11°	221	46	37,5
75	16	105 16 075 6	19,07 €	11°	263	55	43,5
90	16	105 16 090 6	30,27 €	11°	315	66	51
Emniyet kat sayısı (safety factor) C =2,0							
110	16	105 16 110 6	40,34 €	11°	385	81	61
125	16	105 16 125 6	51,83 €	11°	438	92	68,5
140	16	105 16 140 6	71,55 €	11°	490	103	76
160	16	105 16 160 6	101,69 €	11°	560	118	86
200	16	105 16 200 6	193,53 €	11°	700	147	106
225	16	105 16 225 6	273,89 €	11°	788	166	118,5
250	16	105 16 250 6	399,63 €	11°	875	184	131
280	16	105 16 280 6	675,20 €	11°	980	206	146
315	16	105 16 315 6	786,81 €	11°	1103	232	163,5
355	16	105 16 355 6	1.032,96 €	11°	1243	262	183,5
400	16	105 16 400 6	1.509,44 €	11°	1400	295	206
450	16	105 16 450 6	①	11°	1575	332	
500	16	105 16 500 6	①	11°	1750	369	

U-PVC Yapıştırma Muflu Temiz Su Deve Boynu

U-PVC Solvent Cement Socketed Long Bend

22,5° PN 10

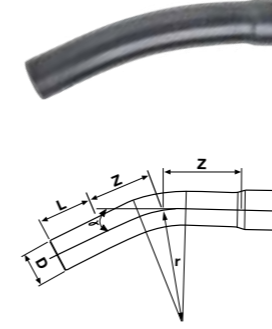

Çap Dia	Basınç (PN)	Kod Code	Fiyat (Adet) Price (Pcs)	Açrı Angle	Yarıçap (R)	Z (mm)	L (mm)
Emniyet kat sayısı (safety factor) C =2,5							
25	10	106 10 025 6	4,86 €	22,5°	63	37	18,5
32	10	106 10 032 6	4,86 €	22,5°	80	48	22
40	10	106 10 040 6	4,86 €	22,5°	100	59	26
50	10	106 10 050 6	4,86 €	22,5°	125	74	31
63	10	106 10 063 6	6,95 €	22,5°	221	68	37,5
75	10	106 10 075 6	10,47 €	22,5°	263	81	43,5
90	10	106 10 090 6	16,71 €	22,5°	315	97	51
Emniyet kat sayısı (safety factor) C =2,0							
110	10	106 10 110 6	23,73 €	22,5°	385	119	61
125	10	106 10 125 6	30,57 €	22,5°	438	135	68,5
140	10	106 10 140 6	42,09 €	22,5°	490	151	76
160	10	106 10 160 6	59,81 €	22,5°	560	173	86
200	10	106 10 200 6	113,84 €	22,5°	700	216	106
225	10	106 10 225 6	160,89 €	22,5°	788	243	118,5
250	10	106 10 250 6	235,08 €	22,5°	875	270	131
280	10	106 10 280 6	350,57 €	22,5°	980	302	146
315	10	106 10 315 6	462,63 €	22,5°	1103	340	163,5
355	10	106 10 355 6	607,28 €	22,5°	1243	384	183,5
400	10	106 10 400 6	887,76 €	22,5°	1400	432	206
450	10	106 10 450 6	①	22,5°	1575	486	
500	10	106 10 500 6	①	22,5°	1750	540	

22,5° PN 16



Çap Dia	Basınç (PN)	Kod Code	Fiyat (Adet) Price (Pcs)	Açrı Angle	Yarıçap (R)	Z (mm)	L (mm)
Emniyet kat sayısı (safety factor) C =2,5							
25	16	106 16 025 6	7,70 €	22,5°	63	37	18,5
32	16	106 16 032 6	7,70 €	22,5°	80	48	22
40	16	106 16 040 6	7,70 €	22,5°	100	59	26
50	16	106 16 050 6	7,70 €	22,5°	125	74	31
63	16	106 16 063 6	11,82 €	22,5°	221	68	37,5
75	16	106 16 075 6	19,07 €	22,5°	263	81	43,5
90	16	106 16 090 6	30,27 €	22,5°	315	97	51
Emniyet kat sayısı (safety factor) C =2,0							
110	16	106 16 110 6	40,34 €	22,5°	385	119	61
125	16	106 16 125 6	51,98 €	22,5°	438	135	68,5
140	16	106 16 140 6	71,55 €	22,5°	490	151	76
160	16	106 16 160 6	101,69 €	22,5°	560	173	86
200	16	106 16 200 6	193,53 €	22,5°	700	216	106
225	16	106 16 225 6	273,89 €	22,5°	788	243	118,5
250	16	106 16 250 6	399,63 €	22,5°	875	270	131
280	16	106 16 280 6	675,20 €	22,5°	980	302	146
315	16	106 16 315 6	786,81 €	22,5°	1103	340	163,5
355	16	106 16 355 6	1.032,96 €	22,5°	1243	384	183,5
400	16	106 16 400 6	1.509,44 €	22,5°	1400	432	206
450	16	106 16 450 6	①	22,5°	1575	486	
500	16	106 16 500 6	①	22,5°	1750	540	

U-PVC Yapıştırma Mufllu Temiz Su Deve Boynu
U-PVC Solvent Cement Socketed Long Bend

30° PN 10

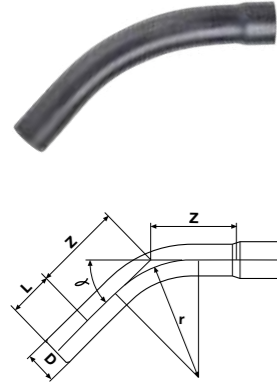

Çap Dia	Basınç PN	Kod Code	Fiyat (Adet) Price (Pcs)	Açı Angle	Yarıçap R	Z mm	L mm
Emniyet kat sayısı (safety factor) C =2,5							
25	10	107 10 025 6	5,54 €	30°	63	42	18,5
32	10	107 10 032 6	5,54 €	30°	80	53	22
40	10	107 10 040 6	5,54 €	30°	100	67	26
50	10	107 10 050 6	5,54 €	30°	125	84	31
63	10	107 10 063 6	8,04 €	30°	221	84	37,5
75	10	107 10 075 6	13,58 €	30°	263	100	43,5
90	10	107 10 090 6	18,93 €	30°	315	120	51
Emniyet kat sayısı (safety factor) C =2,0							
110	10	107 10 110 6	25,04 €	30°	385	147	61
125	10	107 10 125 6	40,26 €	30°	438	167	68,5
140	10	107 10 140 6	54,47 €	30°	490	187	76
160	10	107 10 160 6	71,07 €	30°	560	214	86
200	10	107 10 200 6	142,14 €	30°	700	268	106
225	10	107 10 225 6	190,38 €	30°	788	301	118,5
250	10	107 10 250 6	271,17 €	30°	875	334	131
280	10	107 10 280 6	450,20 €	30°	980	375	146
315	10	107 10 315 6	569,13 €	30°	1103	421	163,5
355	10	107 10 355 6	777,29 €	30°	1243	475	183,5
400	10	107 10 400 6	1.184,07 €	30°	1400	535	206
450	10	107 10 450 6	Ⓜ	30°	1575	602	
500	10	107 10 500 6	Ⓜ	30°	1750	669	

30° PN 16

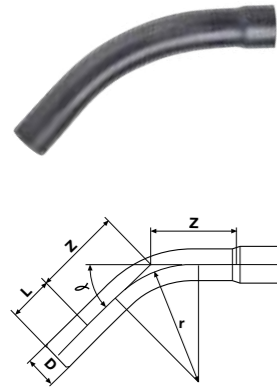

Çap Dia	Basınç PN	Kod Code	Fiyat (Adet) Price (Pcs)	Açı Angle	Yarıçap R	Z mm	L mm
Emniyet kat sayısı (safety factor) C =2,5							
25	16	107 16 025 6	8,48 €	30°	63	42	18,5
32	16	107 16 032 6	8,48 €	30°	80	53	22
40	16	107 16 040 6	8,48 €	30°	100	67	26
50	16	107 16 050 6	8,48 €	30°	125	84	31
63	16	107 16 063 6	14,28 €	30°	221	84	37,5
75	16	107 16 075 6	23,15 €	30°	263	100	43,5
90	16	107 16 090 6	32,24 €	30°	315	120	51
Emniyet kat sayısı (safety factor) C =2,0							
110	16	107 16 110 6	42,47 €	30°	385	147	61
125	16	107 16 125 6	68,39 €	30°	438	167	68,5
140	16	107 16 140 6	92,72 €	30°	490	187	76
160	16	107 16 160 6	120,63 €	30°	560	214	86
200	16	107 16 200 6	241,17 €	30°	700	268	106
225	16	107 16 225 6	322,52 €	30°	788	301	118,5
250	16	107 16 250 6	459,57 €	30°	875	334	131
280	16	107 16 280 6	767,73 €	30°	980	375	146
315	16	107 16 315 6	966,77 €	30°	1103	421	163,5
355	16	107 16 355 6	1.270,25 €	30°	1243	475	183,5
400	16	107 16 400 6	2.011,89 €	30°	1400	535	206
450	16	107 16 450 6	Ⓜ	30°	1575	602	
500	16	107 16 500 6	Ⓜ	30°	1750	669	

U-PVC Yapıştırma Mufllu Temiz Su Deve Boynu
U-PVC Solvent Cement Socketed Long Bend

45° PN 10

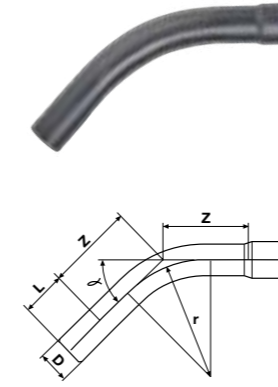

Çap Dia	Basınç PN	Kod Code	Fiyat (Adet) Price (Pcs)	Açı Angle	Yarıçap R	Z mm	L mm
Emniyet kat sayısı (safety factor) C =2,5							
25	10	108 10 025 6	5,54 €	45°	63	51	18,5
32	10	108 10 032 6	5,54 €	45°	80	65	22
40	10	108 10 040 6	5,54 €	45°	100	81	26
50	10	108 10 050 6	5,54 €	45°	125	102	31
63	10	108 10 063 6	8,04 €	45°	221	117	37,5
75	10	108 10 075 6	13,58 €	45°	263	139	43,5
90	10	108 10 090 6	18,93 €	45°	315	166	51
Emniyet kat sayısı (safety factor) C =2,0							
110	10	108 10 110 6	25,04 €	45°	385	203	61
125	10	108 10 125 6	40,26 €	45°	438	231	68,5
140	10	108 10 140 6	54,47 €	45°	490	259	76
160	10	108 10 160 6	71,07 €	45°	560	296	86
200	10	108 10 200 6	142,19 €	45°	700	370	106
225	10	108 10 225 6	190,38 €	45°	788	416	118,5
250	10	108 10 250 6	271,17 €	45°	875	462	131
280	10	108 10 280 6	450,20 €	45°	980	518	146
315	10	108 10 315 6	569,13 €	45°	1103	583	163,5
355	10	108 10 355 6	777,29 €	45°	1243	656	183,5
400	10	108 10 400 6	1.184,07 €	45°	1400	740	206
450	10	108 10 450 6	Ⓜ	45°	1575	832	
500	10	108 10 500 6	Ⓜ	45°	1750	925	

45° PN 16

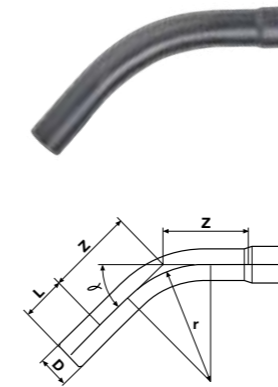

Çap Dia	Basınç PN	Kod Code	Fiyat (Adet) Price (Pcs)	Açı Angle	Yarıçap R	Z mm	L mm
Emniyet kat sayısı (safety factor) C =2,5							
25	16	108 16 025 6	8,48 €	45°	63	51	18,5
32	16	108 16 032 6	8,48 €	45°	80	65	22
40	16	108 16 040 6	8,48 €	45°	100	81	26
50	16	108 16 050 6	8,48 €	45°	125	102	31
63	16	108 16 063 6	14,28 €	45°	221	117	37,5
75	16	108 16 075 6	23,15 €	45°	263	139	43,5
90	16	108 16 090 6	32,24 €	45°	315	166	51
Emniyet kat sayısı (safety factor) C =2,0							
110	16	108 16 110 6	43,97 €	45°	385	203	61
125	16	108 16 125 6	68,39 €	45°	438	231	68,5
140	16	108 16 140 6	92,72 €	45°	490	259	76
160	16	108 16 160 6	120,63 €	45°	560	296	86
200	16	108 16 200 6	241,17 €	45°	700	370	106
225	16	108 16 225 6	322,52 €	45°	788	416	118,5
250	16	108 16 250 6	459,57 €	45°	875	462	131
280	16	108 16 280 6	767,73 €	45°	980	518	146
315	16	108 16 315 6	966,77 €	45°	1103	583	163,5
355	16	108 16 355 6	1.270,25 €	45°	1243	656	183,5
400	16	108 16 400 6	2.011,89 €	45°	1400	740	206
450	16	108 16 450 6	Ⓜ	45°	1575	832	
500	16	108 16 500 6	Ⓜ	45°	1750	925	

U-PVC Yapıştırma Mufllu Temiz Su Deve Boynu

U-PVC Solvent Cement Socketed Long Bend

60° PN 10

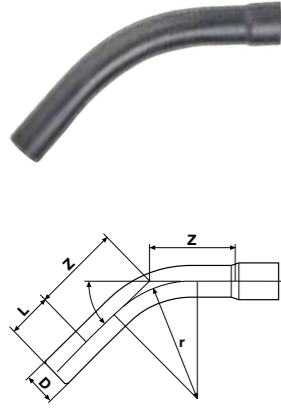

Çap Dia	Basınç PN	Kod Code	Fiyat (Adet) Price (Pcs)	Açı Angle	Yarıçap R	Z mm	L mm
Emniyet kat sayısı (safety factor) C =2,5							
25	10	109 10 025 6	6,18 €	60°	63	61	18,5
32	10	109 10 032 6	6,18 €	60°	80	78	22
40	10	109 10 040 6	6,18 €	60°	100	98	26
50	10	109 10 050 6	6,18 €	60°	125	122	31
63	10	109 10 063 6	9,26 €	60°	221	153	37,5
75	10	109 10 075 6	14,72 €	60°	263	182	43,5
90	10	109 10 090 6	26,00 €	60°	315	218	51
Emniyet kat sayısı (safety factor) C =2,0							
110	10	109 10 110 6	33,35 €	60°	385	266	61
125	10	109 10 125 6	53,13 €	60°	438	303	68,5
140	10	109 10 140 6	70,26 €	60°	490	339	76
160	10	109 10 160 6	96,39 €	60°	560	387	86
200	10	109 10 200 6	191,13 €	60°	700	484	106
225	10	109 10 225 6	271,16 €	60°	788	545	118,5
250	10	109 10 250 6	389,13 €	60°	875	605	131
280	10	109 10 280 6	522,72 €	60°	980	678	146
315	10	109 10 315 6	967,04 €	60°	1103	763	163,5
355	10	109 10 355 6	1.106,43 €	60°	1243	859	183,5
400	10	109 10 400 6	1.701,75 €	60°	1400	968	206
450	10	109 10 450 6	①	60°	1575	1089	
500	10	109 10 500 6	①	60°	1750	1210	

60° PN 16

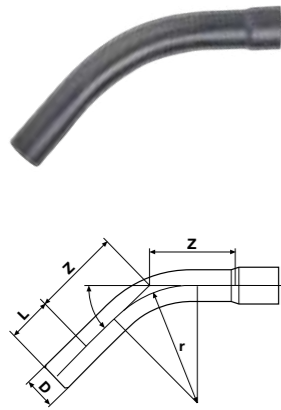

Çap Dia	Basınç PN	Kod Code	Fiyat (Adet) Price (Pcs)	Açı Angle	Yarıçap R	Z mm	L mm
Emniyet kat sayısı (safety factor) C =2,5							
25	16	109 16 025 6	9,12 €	60°	63	61	18,5
32	16	109 16 032 6	9,12 €	60°	80	78	22
40	16	109 16 040 6	9,12 €	60°	100	98	26
50	16	109 16 050 6	9,12 €	60°	125	122	31
63	16	109 16 063 6	15,72 €	60°	221	153	37,5
75	16	109 16 075 6	25,04 €	60°	263	182	43,5
90	16	109 16 090 6	44,15 €	60°	315	218	51
Emniyet kat sayısı (safety factor) C =2,0							
110	16	109 16 110 6	56,73 €	60°	385	266	61
125	16	109 16 125 6	90,32 €	60°	438	303	68,5
140	16	109 16 140 6	119,45 €	60°	490	339	76
160	16	109 16 160 6	165,00 €	60°	560	387	86
200	16	109 16 200 6	323,43 €	60°	700	484	106
225	16	109 16 225 6	460,65 €	60°	788	545	118,5
250	16	109 16 250 6	657,36 €	60°	875	605	131
280	16	109 16 280 6	887,04 €	60°	980	678	146
315	16	109 16 315 6	1.643,67 €	60°	1103	763	163,5
355	16	109 16 355 6	1.887,60 €	60°	1243	859	183,5
400	16	109 16 400 6	2.892,39 €	60°	1400	968	206
450	16	109 16 450 6	①	60°	1575	1089	
500	16	109 16 500 6	①	60°	1750	1210	

U-PVC Yapıştırma Mufllu Temiz Su Deve Boynu

U-PVC Solvent Cement Socketed Long Bend

90° PN 10

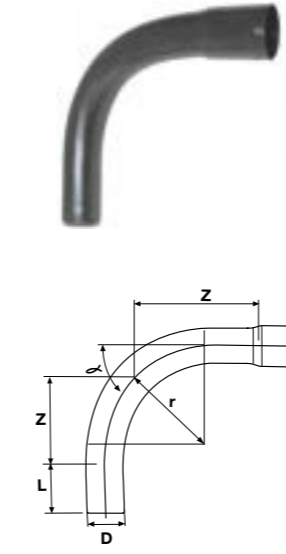

Çap Dia	Basınç PN	Kod Code	Fiyat (Adet) Price (Pcs)	Açı Angle	Yarıçap R	Z mm	L mm
Emniyet kat sayısı (safety factor) C =2,5							
25	10	110 10 025 6	6,18 €	90°	63	88	18,5
32	10	110 10 032 6	6,18 €	90°	80	112	22
40	10	110 10 040 6	6,18 €	90°	100	140	26
50	10	110 10 050 6	6,18 €	90°	125	175	31
63	10	110 10 063 6	9,26 €	90°	221	246	37,5
75	10	110 10 075 6	14,72 €	90°	263	293	43,5
90	10	110 10 090 6	26,00 €	90°	315	351	51
Emniyet kat sayısı (safety factor) C =2,0							
110	10	110 10 110 6	33,35 €	90°	385	429	61
125	10	110 10 125 6	53,13 €	90°	438	488	68,5
140	10	110 10 140 6	70,26 €	90°	490	546	76
160	10	110 10 160 6	96,39 €	90°	560	624	86
200	10	110 10 200 6	191,13 €	90°	700	780	106
225	10	110 10 225 6	271,16 €	90°	788	878	118,5
250	10	110 10 250 6	389,13 €	90°	875	975	131
280	10	110 10 280 6	522,72 €	90°	980	1092	146
315	10	110 10 315 6	967,04 €	90°	1103	1229	163,5
355	10	110 10 355 6	1.106,43 €	90°	1243	1385	183,5
400	10	110 10 400 6	1.701,75 €	90°	1400	1560	206
450	10	110 10 450 6	①	90°	1575	1755	
500	10	110 10 500 6	①	90°	1750	1950	

90° PN 16

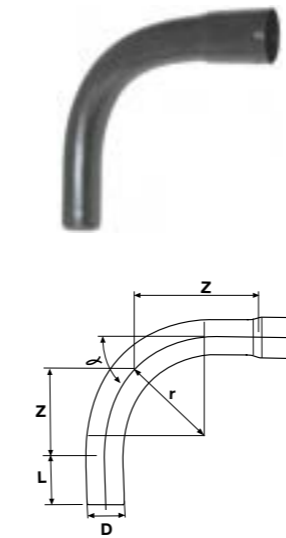

Çap Dia	Basınç PN	Kod Code	Fiyat (Adet) Price (Pcs)	Açı Angle	Yarıçap R	Z mm	L mm
Emniyet kat sayısı (safety factor) C =2,5							
25	16	110 16 025 6	9,12 €	90°	63	88	18,5
32	16	110 16 032 6	9,12 €	90°	80	112	22
40	16	110 16 040 6	9,12 €	90°	100	140	26
50	16	110 16 050 6	9,12 €	90°	125	175	31
63	16	110 16 063 6	15,72 €	90°	221	246	37,5
75	16	110 16 075 6	25,04 €	90°	263	293	43,5
90	16	110 16 090 6	44,15 €	90°	315	351	51
Emniyet kat sayısı (safety factor) C =2,0							
110	16	110 16 110 6	56,73 €	90°	385	429	61
125	16	110 16 125 6	90,32 €	90°	438	488	68,5
140	16	110 16 140 6	119,45 €	90°	490	546	76
160	16	110 16 160 6	165,00 €	90°	560	624	86
200	16	110 16 200 6	323,43 €	90°	700	780	106
225	16	110 16 225 6	460,65 €	90°	788	878	118,5
250	16	110 16 250 6	657,36 €	90°	875	975	131
280	16	110 16 280 6	887,04 €	90°	980	1092	146
315	16	110 16 315 6	1.643,67 €	90°	1103	1229	163,5
355	16	110 16 355 6	1.887,60 €	90°	1243	1385	183,5
400	16	110 16 400 6	2.892,39 €	90°	1400	1560	206
450	16	110 16 450 6	①	90°	1575	1755	
500	16	110 16 500 6	①	90°	1750	1950	

U-PVC Kayar Manşon PN 16

U-PVC Double Socketed Sleeve PN 16

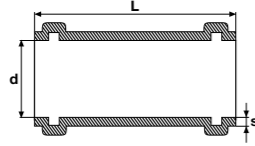

Çap Dia	Basınç PN	Kod Code	Fiyat (Adet) Price (Pcs)	Koli/ Adet Box/Pcs	Kg/Adet Kg/Pcs	S (mm)	L (mm)
*50	16	117 00 050 6	2,48 €	30	0,170	3,7	180
63	16	117 00 063 2	5,87 €	32	0,350	4,7	225
75	16	117 00 075 2	7,85 €	22	0,560	5,6	255
90	16	117 00 090 2	12,30 €	15	0,940	6,7	275
110	16	117 00 110 2	21,71 €	10	1,060	6,6	290
*125	16	117 00 125 6	21,89 €	7	1,670	7,4	290
*140	16	117 00 140 6	25,35 €	5	2,130	8,3	355
160	16	117 00 160 2	32,48 €	3	2,440	9,5	310
*200	16	117 00 200 5	59,24 €	2	4,100	11,9	338
*225	16	117 00 225 5	81,68 €	1	5,500	13,4	360
*250	16	117 00 250 5	149,82 €	1	7,230	14,8	385
*280	16	117 00 280 5	116,00 €	1	10,210	16,6	460
*315	16	117 00 315 6	223,41 €	1	13,730	18,7	460
*355	16	117 00 355 2	314,16 €	1	22,020	21,1	562
*400	16	117 00 400 6	449,46 €	1	27,990	23,7	602

Konfeksiyon. Hand-made from pipe
Conta dahil değildir. Gasket is not included the price.

EPDM Temiz Su Borusu Üçgen Conta

EPDM Rubber Triangle Gasket

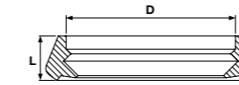

Çap Dia	Kod Code	Fiyat (Adet) Price (Pcs)	Koli/ Adet Box/Pcs	L (mm)
50	101 00 050 8	0,80 €		14
63	101 00 063 8	0,87 €	300	16,5
75	101 00 075 8	1,19 €	240	19,5
90	101 00 090 8	1,34 €	120	22
110	101 00 110 8	1,89 €	80	24
125	101 00 125 8	2,97 €	64	25
140	101 00 140 8	3,14 €	50	26
160	101 00 160 8	3,78 €	44	27
200	101 00 200 8	5,82 €	40	30,5
225	101 00 225 8	8,28 €	25	33
250	101 00 250 8	9,05 €	20	36
280	101 00 280 8	12,36 €	30	
315	101 00 315 8	18,12 €	40	
355	101 00 355 8	24,42 €	25	
400	101 00 400 8	33,08 €	25	
450	101 00 450 8	①		
500	101 00 500 8	①		

EPDM Temiz Su Borusu Kare Conta

EPDM Rubber Ring Gasket

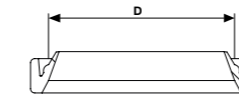

Çap Dia	Kod Code	Fiyat (Adet) Price (Pcs)	Koli/ Adet Box/Pcs
50	101 00 050 9	0,80 €	
63	101 00 063 9	0,87 €	300
75	101 00 075 9	1,19 €	240
90	101 00 090 9	1,34 €	120
110	101 00 110 9	1,89 €	80
125	101 00 125 9	2,97 €	64
140	101 00 140 9	3,14 €	50
160	101 00 160 9	3,78 €	44
200	101 00 200 9	5,82 €	40
225	101 00 225 9	8,28 €	25
250	101 00 250 9	9,05 €	20
280	101 00 280 9	12,36 €	30
315	101 00 315 9	18,12 €	40
355	101 00 355 9	24,42 €	25
400	101 00 400 9	33,08 €	25
450	101 00 450 9	①	
500	101 00 500 9	①	

Not / Note

PP

KELEPÇELER PIPE CLAMP

ÜRETİM STANDARDI
PRODUCTION STANDARD | EN 1452-2

ÇAP / SIZE Ø20 - Ø200



Boru Kelepçesi
Pipe Clamp

YENİ / NEW



Model A

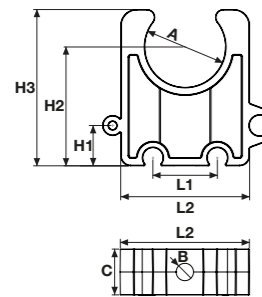

Model B

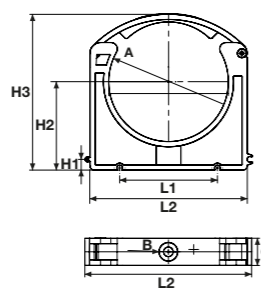

Model C

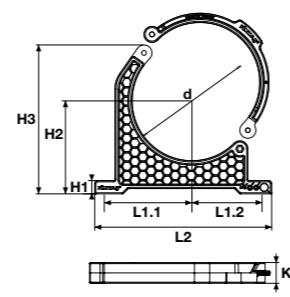

Model A

Çap Dia	Kod Code	Fiyat (Adet) Price (Pcs)	A (mm)	B (mm)	C (mm)	L1 (mm)	L2 (mm)	H1 (mm)	H2 (mm)	H3 (mm)
20	118 00 020 4	0,08 €	20	5,5	14,5	16	32	10	29,5	38,9
25	118 00 025 4	0,09 €	25	5,5	14,5	20	37	10	32	42,15
32	118 00 032 4	0,14 €	32	5,5	14,5	24	46	10	35,5	47,5

Model B

Çap Dia	Kod Code	Fiyat (Adet) Price (Pcs)	A (mm)	B (mm)	C (mm)	L1 (mm)	L2 (mm)	H1 (mm)	H2 (mm)	H3 (mm)
40	118 00 040 4	0,16 €	40	6,5	18	30	56	10	46,5	70,4
50	118 00 050 4	0,22 €	50	6,5	20	40	66	10	51,5	80,4
63	118 00 063 4	0,46 €	63	8,5	22	50	82	10	58	92,9
75	118 00 075 4	0,58 €	75	8,5	23	60	96	10	64	106,9
90	118 00 090 4	0,89 €	90	8,5	23	70	115	10	71,5	124,4
110	118 00 110 4	0,91 €	110	8,5	25	90	145	10	81,5	143,8
125	118 00 125 4	1,42 €	125	8,5	28	120	165	10	90	161,6
140	118 00 140 4	1,60 €	140	8,5	28	125	185	10	100	180,7
160	118 00 160 4	2,44 €	160	8,5	28	140	209	10	110	200,8
200	118 00 200 4	3,33 €	200	8,5	28	160	255	10	130	241,6

Model C

Çap Dia	Kod Code	Fiyat (Adet) Price (Pcs)	L1/1 (mm)	L1/2 (mm)	L2 (mm)	H1 (mm)	H2 (mm)	H3 (mm)	K (mm)
225	118 00 225 4	10,14 €	165	132	333	25	175	265,23	39
250	118 00 250 4	12,37 €	185	155	366	25	200	314,17	39
280	118 00 280 4	13,38 €	200	156	392	25	200	320,81	39
315	118 00 315 4	15,56 €	220	172	428	25	229	362,18	39

Boru Kelepçesi Yükseltme Kiti
Pipe Clamp Lifting Kit

YENİ / NEW

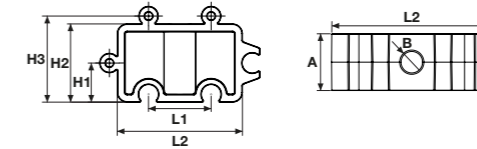

Çap Dia	Kod Code	Fiyat (Adet) Price (Pcs)	A (mm)	B (mm)	L1 (mm)	L2 (mm)	H1 (mm)	H2 (mm)	H3 (mm)	Ağırlık (gr)
20	118 01 020 4	0,08 €	14,5	5,5	16	32	10	20	22	4,34
25	118 01 025 4	0,09 €	14,5	5,5	20	37	10	20	22	4,75
32	118 01 032 4	0,14 €	14,5	5,5	24	46	10	20	22	6,22
40	118 01 040 4	0,16 €	18	6,5	30	56	10	20	22	8,85
50	118 01 050 4	0,22 €	20	6,5	40	66	10	20	22	11,25
63	118 01 063 4	0,46 €	22	8,5	50	82	10	20	22	16,54
75	118 01 075 4	0,58 €	23	8,5	60	96	10	20	22	20,67
90	118 01 090 4	0,89 €	23	8,5	70	115	10	20	22	24,9
110	118 01 110 4	0,91 €	25	8,5	90	145	10	20	22	35,03



Somun Kelepçe (Metal)

Metal Clamp With Nut



Çap Dia	Kod Code	Fiyat (Adet) Price (Pcs)	Koli/Adet Box/Pcs	Kg/Adet Kg/Pcs	Sıkma Aralığı	Çap (mm)	Askı Somunu	Saç (mm)	Bağlantı vidası
20	119 00 020 8	0,39 €	200	0,057	20-24	21	M8	1,5x20	M5
25	119 00 025 8	0,42 €	200	0,06	25-28	27	M8	1,5x20	M5
32	119 00 032 8	0,45 €	150	0,07	32-35	34	M8	1,5x20	M5
40	119 00 040 8	0,52 €	100	0,087	39-46	42	M8	1,5x20	M6
50	119 00 050 8	0,57 €	100	0,096	48-53	48	M8	1,5x20	M6
63	119 00 063 8	1,00 €	75	0,112	56-66	60	M8	1,5x20	M6
75	119 00 075 8	1,16 €	30	0,171	75-80	76	M10	2x25	M6
90	119 00 090 8	1,25 €	30	0,189	86-94	89	M10	2x25	M6
110	119 00 110 8	1,54 €	25	0,312	110-116	114	M10	2,5x25	M6
125	119 00 125 8	2,09 €	25	0,256	123-126	120	M10	2,5x25	M6
140	119 00 140 8	2,24 €	25	0,36	135-143	140	M10	2,5x25	M6
160	119 00 160 8	2,36 €	25	0,342	163-170	165	M10	2,5x25	M6
200	119 00 200 8	2,70 €	25	0,377	207-219	219	M10	2,5x25	M6

Somunlu Ağır Yük Kelepçesi (Metal)

Metal Clamp With Nut Heavy Load



Çap Dia	Kod Code	Fiyat (Adet) Price (Pcs)	Koli/Adet Box/Pcs	Kg/Adet Kg/Pcs	Sıkma Aralığı	Çap (mm)	Askı Somunu	Saç (mm)	Bağlantı vidası
20	119 01 020 8	1,47 €	50		21-28	30	M12	2x25	M8
25	119 01 025 8	1,47 €	50	1	25-32	33	M12	2x25	M8
32	119 01 032 8	1,50 €	50	1,5	33-40	36,5	M12	2x25	M8
40	119 01 040 8	1,56 €	50	1	41-48	41	M12	2x25	M8
50	119 01 050 8	1,69 €	40	0,28	48-56	44,5	M12	2x25	M8
63	119 01 063 8	1,85 €	30	0,39	60-69	51	M12	2x25	M8
75	119 01 075 8	2,00 €	30	0,35	75-81	59	M12	2x25	M8
90	119 01 090 8	2,17 €	30	0,39	87-95	65	M12	2x25	M8
110	119 01 110 8	2,66 €	30	0,45	109-119	78,6	M12	2,5x30	M8
125	119 01 125 8	4,16 €	10	0,65	136-147	96,1	M16	3x30	M10
140	119 01 140 8	4,36 €	10	0,75	153 - 164	104,1	M16	3x30	M10
160	119 01 160 8	4,65 €	10	1,1	164-174	108,6	M16	3x30	M10
200	119 01 200 8	①	15	2,5	214-226	133,6	M16	3x30	M10

Trifonlu Kelepçe

Metal Clamp With Screw



Çap Dia	Kod Code	Fiyat (Adet) Price (Pcs)	Koli/Adet Box/Pcs	Kg/Adet Kg/Pcs	Sıkma Aralığı	Çap (mm)	Askı Somunu	Saç (mm)	Bağlantı vidası
20	120 00 020 8	0,40 €	100	0,06	20-24	21	8x60	1,5x20	M5
25	120 00 025 8	0,43 €	100	0,066	25-28	27	8x60	1,5x20	M5
32	120 00 032 8	0,47 €	75	0,076	32-35	34	8x60	1,5x20	M5
40	120 00 040 8	0,52 €	50	0,082	39-46	42	8x60	1,5x20	M6
50	120 00 050 8	0,57 €	50	0,092	48-53	48	8x60	1,5x20	M6
63	120 00 063 8	0,90 €	50	0,103	56-66	60	8x60	1,5x20	M6
75	120 00 075 8	1,10 €	50	0,168	75-80	76	8x60	2x25	M6
90	120 00 090 8	1,25 €	25	0,182	86-94	89	8x60	2x25	M6
110	120 00 110 8	1,60 €	25	0,237	110-116	114	8x60	2,5x25	M6
125	120 00 125 8	2,00 €	25	0,265					M6
140	120 00 140 8	2,25 €	25	0,85					M6

Uzun Trifonlu Kelepçe

Metal Clamp With Screw Long Bolt



Çap Dia	Kod Code	Fiyat (Adet) Price (Pcs)	Koli/Adet Box/Pcs	Kg/Adet Kg/Pcs	Sıkma Aralığı	Çap (mm)	Askı Somunu	Saç (mm)	Bağlantı vidası
20	120 01 020 8	0,68 €	150	0,07	20-24	21	8x60	1,5x20	M5
25	120 01 025 8	0,72 €	150	0,08	25-28	27	8x60	1,5x20	M5
32	120 01 032 8	0,78 €	100	0,09	32-35	34	8x60	1,5x20	M5
40	120 01 040 8	0,90 €	75	0,09	39-46	42	8x60	1,5x20	M6
50	120 01 050 8	0,99 €	75	0,09	48-53	48	8x60	1,5x20	M6
63	120 01 063 8	1,73 €	50	0,11	56-66	60	8x60	1,5x20	M6
75	120 01 075 8	2,00 €	30	0,12	75-80	76	8x60	2x25	M6
90	120 01 090 8	2,16 €	30	0,22	86-94	89	8x60	2x25	M6
110	120 01 110 8	2,66 €	25	0,23	110-116	114	8x60	2,5x25	M6

Somunlu Ağır Yük Kelepçesi (Kafalı)

Metal Clamp With Nut Heavy Load



Çap Dia	Kod Code	Fiyat (Adet) Price (Pcs)	Koli/Adet Box/Pcs	Kg/Adet Kg/Pcs	Sıkma Aralığı	Çap (mm)	Askı Somunu	Saç (mm)	Bağlantı vidası
50	119 02 050 8	1,71 €	50	0,28	48-58	48	M8	1,5x20	M6
63	119 02 063 8	3,00 €	40	0,39	56-60	60	M8	1,5x20	M6
75	119 02 075 8	3,48 €	25	0,2352	75-80	76	M10	2x25	M6
90	119 02 090 8	3,75 €	25	0,2364	86-91	89	M10	2x25	M6
110	119 02 110 8	4,62 €	25	0,236	110-115	114	M10	2,5x25	M6
125	119 02 125 8	6,27 €	10		123-126	120	M10	2,5x25	M6
140	119 02 140 8	6,72 €	10	1,07	138-142	140	M10	2,5x25	M6
160	119 02 160 8	7,08 €	10	1,1	160-165	165	M10	2,5x25	M6
200	119 02 200 8	8,10 €	5		195-200	219	M10	2,5x25	M6

Sprinkler Kelepçe
Sprinkler Clamp



Çap Dia	Kod Code	Fiyat (Adet) Price (Pcs)	Koli/Adet Box/Pcs	Kg/Adet Kg/Pcs	Sıkma Aralığı	Çap (mm)	Askı Somunu	Saç (mm)	Bağlantı vidası
25	119 03 025 8	0,52 €	100	0,06	25-28	27	M8	1,5x20	M5
32	119 03 032 8	0,58 €	100	0,07	32-35	34	M8	1,5x20	M5
40	119 03 040 8	0,66 €	100	0,08	40-45	42	M8	1,5x20	M6
50	119 03 050 8	0,70 €	75	0,09	48-58	48	M8	1,5x20	M6
63	119 03 063 8	0,74 €	50	0,1	56-60	60	M8	1,5x20	M6
75	119 03 075 8	1,16 €	50	0,11	75-80	76	M10	2x25	M6
90	119 03 090 8	1,32 €	50	0,15	86-91	89	M10	2x25	M6
110	119 03 110 8	1,54 €	25	0,21	110-115	114	M10	2,5x25	M6
140	119 03 140 8	2,34 €	25	0,23	138-142	140	M10	2,5x25	M6
160	119 03 160 8	2,62 €	25	0,45	160-165	165	M10	2,5x25	M6

U Bolt
U Bolt



Çap Dia	Kod Code	Fiyat (Adet) Price (Pcs)	Koli/Adet Box/Pcs	Kg/Adet Kg/Pcs	d	L	Açma Aralığı
1/2"	119 04 020 8	0,52 €	100	0,02	M-6		24
3/4"	119 04 025 8	0,58 €	100	0,02	M-6		30
1"	119 04 032 8	0,75 €	100	0,05	M-8		36
1 1/4"	119 04 040 8	0,92 €	70	0,05	M-8		46
1 1/2"	119 04 050 8	1,04 €	50	0,06	M-8		52
2"	119 04 063 8	1,44 €	50	0,12	M-10		64
2 1/2"	119 04 075 8	1,67 €	30	0,14	M-10		78
3"	119 04 090 8	2,59 €	25	0,25	M-12		94
4"	119 04 110 8	3,45 €	25	0,28	M-12		118
5"	119 04 140 8	3,85 €	10	0,35	M-12		146
6"	119 04 160 8	8,86 €	10	0,71	M-16		172
8"	119 04 225 8	9,20 €	10	0,95	M-16		224
10"	119 04 280 8	13,80 €	5	1,20	M-16		278
12"	119 04 315 8	17,25 €	5	1,60	M-16		328

C Kanal
Canal C



Kod Code	Fiyat (Adet) Price (Pcs)	a (mm)	b (mm)	m (mm)	L (mm)	Uzunluk Length
119 00 001 8	12,08 €	27	18	1,25	2000	2000
119 00 002 8	17,83 €	28	30	1,75	2000	2000
119 00 003 8	31,05 €	38	40	2,00	2000	2000

U Kanal
Canal U



Kod Code	Fiyat (Adet) Price (Pcs)	a (mm)	b (mm)	m (mm)	L (mm)	Uzunluk Length
119 00 004 8	22,43 €	30	30	3	2000	2000
119 00 005 8	31,63 €	40	40	3	2000	2000
119 00 006 8	40,25 €	40	40	4	2000	2000
119 00 007 8	50,60 €	50	40	4	2000	2000

L Kanal
Canal L



Kod Code	Fiyat (Adet) Price (Pcs)	a (mm)	b (mm)	m (mm)	L (mm)	Uzunluk Length
119 00 008 8	15,53 €	30	30	3	2000	2000
119 00 009 8	21,28 €	40	40	3	2000	2000
119 00 010 8	25,88 €	40	40	4	2000	2000
119 00 011 8	35,08 €	50	50	4	2000	2000

Boru Gömleklİ Dübel
Sleeve Pipe Anchor



Çap Dia	Kod Code	Fiyat (Adet) Price (Pcs)	Koli/Adet Box/Pcs	D	d	L
M-6	119 00 024 8	0,48 €	100	10	6	65
M-8	119 00 025 8	1,10 €	100	13	8	65
M-10	119 00 026 8	1,50 €	100	15	10	85
M-12	119 00 027 8	1,50 €	100	16	12	90

Çakmalı Dübel
Drop-In Anchor



Çap Dia	Kod Code	Fiyat (Adet) Price (Pcs)	Koli/Adet Box/Pcs	D (mm)	d (mm)	L (mm)
M-6	119 00 012 8	0,35 €	100	8	6	30
M-8	119 00 013 8	0,38 €	100	10	8	35
M-10	119 00 014 8	0,53 €	100	12	10	40
M-12	119 00 015 8	0,94 €	100	15	12	50

Çekmeceli Dübel
Cavity Anchor



Çap Dia	Kod Code	Fiyat (Adet) Price (Pcs)	Koli/Adet Box/Pcs	D (mm)	d (mm)	L (mm)
M-6	119 00 016 8	0,58 €	100	10	6	30
M-8	119 00 017 8	0,58 €	100	13	8	35
M-10	119 00 018 8	0,92 €	100	15	10	45
M-12	119 00 019 8	1,38 €	100	17	12	50

Saç Gömleklİ Dübel
Sleeve Sheet Anchor



Çap Dia	Kod Code	Fiyat (Adet) Price (Pcs)	Koli/Adet Box/Pcs	D (mm)	d (mm)	L (mm)
M-6	119 00 020 8	0,25 €	100	8	6	65
M-8	119 00 021 8	0,44 €	100	10	8	65
M-10	119 00 022 8	0,74 €	100	12	10	85
M-12	119 00 023 8	1,50 €	100	16	12	90

Gijon (Galvanizli)
Gijon (Galvanised)



Çap Dia	Kod Code	Fiyat (Adet) Price (Pcs)	Uzunluk Length
M6 x 1000	119 00 112 8	2,82 €	1000
M8 x 1000	119 00 111 3	4,20 €	1000
M10 x 1000	119 00 111 4	6,66 €	1000
M12 x 1000	119 00 111 5	9,66 €	1000
M16 x 1000	119 00 111 6	21,84 €	1000

Not / Note

PVC

TEKNİK MALZEMELER TECHNICAL MATERIALS



PVC-U Yapıştırıcı 1000 Gr
 PVC-U Solvent 1000 Gr

ML / L	Kod Code	Fiyat (Adet) Price (Pcs)	Koli /Adet Box/Pcs
1000	13 01 10 00 8	20,00 €	8
500	13 01 05 00 8	12,00 €	12
250	13 01 02 50 8	7,00 €	24

PVC-U Temizleyici
 PVC-U Cleaner 1000 Gr

Kg	Kod Code	Fiyat (Adet) Price (Pcs)	Koli /Adet Box/Pcs
1000	13 10 0100 8	19,50 €	12

U-PVC Boruların Birbirine Eklenmesi
 Connection Of U-PVC Pipes

1) Öncelikle birbirine yapıştırılacak olan parçaların yapıştırma bölgeleri temizleyici sıvı kullanılarak bütün toz, yağ, pislik ve çapaklardan temizlenir.

1) First of all the glueign parts have to be clean by cleanser liquid for purge the parts from dust, oil and bur.



2) Yapıştırma alanı muf boyuna göre işaretlenir.

2) Glueing area has to marked accord-ing to solvent cement socket connection lenght.



3) Yapıştırılacak olan her iki parça üzerinde yapıştırma bölgeleri uygun bir şekilde zımparalanır. Zımparalama işleminden sonra tekrar temizleme sıvısı ile yapıştırma bölgeleri temizlenir ve kurulanır.

3) On both of two parts, glueing area have to rubbing with sand-paper. After rubbing pro-cess glueing areas have to be clean by cleanser liquid and to be dry.



4) Yapıştırılacak olan her iki parça üzerine temiz bir fırça ile boylamasına olarak yapıştırıcı sürülür. Parçalar üzerine gereğinden fazla yapıştırıcı sürüldüyse bu fazla sürülen yapıştırıcı kutusuna geri alınır.

4) Pimtaş Solvent Cement has to apply on two glueing areas with a clear brush as lon-gitudional. In case of pouring, excess glue should be taken back into the glue can.



5) Yapıştırıcı uygun bir şekilde sürüldükten sonra parçalar hiç beklemeden hızlı bir şekilde ve döndürülmeden birbiri içine itilir.

5) After correct application of glue, parts must pushing each other as nonstop, straightly and very quickly.



6) Parçalar birbiri içine itilince dışarı taşan fazla yapıştırıcı temizlenir.

6) Later on pushed parts to inside each other and came off over glue should be cleaning.

U-PVC Plaka (Koyu Gri)
 U-PVC Plate (Dark Grey)

Çap Dia	Kod Code	Fiyat (Adet) Price (Pcs)	Plaka Ölçüsü Plate Dia 2000x1000 kg	Plaka Ölçüsü Plate Dia 3000x1500 kg
3	127 00 003 3	12,00 €	8,64	19,44
4	127 00 004 3	12,00 €	11,52	25,92
5	127 00 005 3	12,00 €	14,40	32,40
6	127 00 006 3	12,00 €	17,28	38,88
7	127 00 007 3	12,00 €	20,16	45,36
8	127 00 008 3	12,00 €	23,04	51,84
10	127 00 010 3	12,00 €	28,80	64,80
12	127 00 012 3	12,00 €	34,56	77,76
15	127 00 015 3	12,00 €	43,20	97,20
20	127 00 020 3	12,00 €	57,60	129,60
25	127 00 025 3	12,00 €	72,00	162,00
30	127 00 030 3	12,00 €	86,40	194,40

PP Plaka (Bej)
 PP Plate (Beige)

Çap Dia	Kod Code	Fiyat (Adet) Price (Pcs)	Plaka Ölçüsü Plate Dia 2000x1000 kg	Plaka Ölçüsü Plate Dia 3000x1500 kg
3	127 01 003 3	12,00 €	5,55	12,56
4	127 01 004 3	12,00 €	7,42	16,74
5	127 01 005 3	12,00 €	9,29	20,93
6	127 01 006 3	12,00 €	11,09	25,11
7	127 01 007 3	12,00 €		
8	127 01 008 3	12,00 €	14,88	33,48
10	127 01 010 3	12,00 €	18,61	41,85
12	127 01 012 3	12,00 €	22,32	50,22
15	127 01 015 3	12,00 €	27,91	62,78
20	127 01 020 3	12,00 €	37,19	83,72
25	127 01 025 3	12,00 €	46,49	104,47
30	127 01 030 3	12,00 €	55,81	125,56

HDPE Plaka (Siyah)
 HDPE Plate (Black)

Çap Dia	Kod Code	Fiyat (Adet) Price (Pcs)	Plaka Ölçüsü Plate Dia 2000x1000 kg	Plaka Ölçüsü Plate Dia 3000x1500 kg
3	127 02 003 3	12,00 €	5,76	12,96
4	127 02 004 3	12,00 €	7,65	17,28
5	127 02 005 3	12,00 €	9,62	21,62
6	127 02 006 3	12,00 €	11,52	25,93
7	127 02 007 3	12,00 €		
8	127 02 008 3	12,00 €	15,36	34,56
10	127 02 010 3	12,00 €	19,21	43,22
12	127 02 012 3	12,00 €	23,04	51,88
15	127 02 015 3	12,00 €	28,81	64,83
20	127 02 020 3	12,00 €	38,41	86,45
25	127 02 025 3	12,00 €	48,01	108,01
30	127 02 030 3	12,00 €	57,61	129,65

U-PVC İçi Dolu Kütük (Beyaz)

U-PVC Solid Rod (White)



Çap Dia	Kod Code	Fiyat (Kg) Price (Kg)	Kg/m
10	126 00 010 3	24,00 €	0,110
12	126 00 012 3	24,00 €	0,180
15	126 00 015 3	24,00 €	0,275
16	126 00 016 3	24,00 €	0,300
18	126 00 018 3	24,00 €	0,378
20	126 00 020 3	24,00 €	0,500
22	126 00 022 3	24,00 €	0,600
25	126 00 025 3	24,00 €	0,750
28	126 00 028 3	24,00 €	0,900
30	126 00 030 3	24,00 €	1,050
32	126 00 032 3	24,00 €	1,170
35	126 00 035 3	24,00 €	1,350
36	126 00 036 3	24,00 €	1,500
40	126 00 040 3	24,00 €	1,900
45	126 00 045 3	24,00 €	2,400
50	126 00 050 3	24,00 €	2,900
55	126 00 055 3	24,00 €	3,500
60	126 00 060 3	24,00 €	4,200

Kütük Uzunluğu 2 m/adet / Solid Rod Length 2 m/pcs

HDPE İçi Dolu Kütük (Siyah)

HDPE Solid Rod (Black)



Çap Dia	Kod Code	Fiyat (Kg) Price (Kg)	Kg/m
10	126 02 010 3	30,00 €	
12	126 02 012 3	30,00 €	
15	126 02 015 3	30,00 €	
16	126 02 016 3	30,00 €	
18	126 02 018 3	30,00 €	
20	126 02 020 3	30,00 €	
22	126 02 022 3	30,00 €	
25	126 02 025 3	30,00 €	
28	126 02 028 3	30,00 €	
30	126 02 030 3	30,00 €	
32	126 02 032 3	30,00 €	
35	126 02 035 3	30,00 €	
36	126 02 036 3	30,00 €	
40	126 02 040 3	30,00 €	
45	126 02 045 3	30,00 €	
50	126 02 050 3	30,00 €	
55	126 02 055 3	30,00 €	
60	126 02 060 3	30,00 €	

Kütük Uzunluğu 2 m/adet / Solid Rod Length 2 m/pcs

PP İçi Dolu Kütük (Bej)

PP Solid Rod (Beige)



Çap Dia	Kod Code	Fiyat (Kg) Price (Kg)	Kg/m
10	126 01 010 3	30,00 €	0,078
12	126 01 012 3	30,00 €	0,114
15	126 01 015 3	30,00 €	0,176
16	126 01 016 3	30,00 €	0,195
18	126 01 018 3	30,00 €	
20	126 01 020 3	30,00 €	0,312
22	126 01 022 3	30,00 €	
25	126 01 025 3	30,00 €	0,484
28	126 01 028 3	30,00 €	
30	126 01 030 3	30,00 €	0,694
32	126 01 032 3	30,00 €	0,767
35	126 01 035 3	30,00 €	0,947
36	126 01 036 3	30,00 €	
40	126 01 040 3	30,00 €	1,230
45	126 01 045 3	30,00 €	1,560
50	126 01 050 3	30,00 €	1,950
55	126 01 055 3	30,00 €	2,300
60	126 01 060 3	30,00 €	2,800

Kütük Uzunluğu 2 m/adet / Solid Rod Length 2 m/pcs

Sıcak Hava Kaynak Makinesi ve Aksesuarları

Hot Air Welding Machine and Accessories



Parça Adı Description Of Item	Kod Code	Fiyat (Adet) Price (Pcs)
Elektronik El Kaynak Makinası Electronic Hot Air Welding Machine	128 00 1500 8	1
Test Cihazı / Test Equipment	128 01 0000 8	1
50x300x2,5 mm Ağızlık / Nozzle	128 02 4000 8	1
50x150 mm Ağızlık / Nozzle	128 03 4002 8	1
40 mm Ağızlık / Nozzle	128 04 4003 8	1
40 mm Merdere / Runner	128 05 5010 8	1
50x70 mm Ağızlık / Nozzle	128 06 5011 8	1
90° Ağızlık / Nozzle	128 07 5012 8	1
20° Ağızlık / Nozzle	128 08 5015 8	1
5 mm Yuvarlak Ağızlık / Rounded Nozzle	128 09 7001 8	1
5 mm Çatal Ağızlık / Slotted Nozzle	128 01 0001 8	1
7,5 mm Üçgen Ağızlık / Triangular Nozzle	128 01 0002 8	1
Mantar / Cork	128 01 0003 8	1

Teknik Veriler

Technical Specifications

Gerilim / Voltage	V	220/230
Güç / Power	W	1550
Frekans / Frequency	Hz	50/60
Isı Ayar Aralığı / Heat Adjustment Step	°C	20-650
Hava Akımı / Air Flow	l/dak	~250
Statik Basınç / Statical Pressure	Pa	~3000
Gürültü Seviyesi / Noise Level	dB	64
Ağırlık / Weight	kg	1,3(kabloyla)/(with cable)
İşaretleme / Marking		CE

U-PVC Kaynak Çubuğu

U-PVC Welding Rods



Çap Dia	Kod Code	Fiyat (Adet) Price (Pcs)	Kg /Koli Kg/Box
3	123 00 003 1	16,50 €	2
4	123 00 004 1	16,50 €	2
5	123 00 005 1	16,50 €	2
6	123 00 006 1	16,50 €	2
7	123 00 007 1	16,50 €	2
8	123 00 008 1	16,50 €	2
9	123 00 009 1	16,50 €	2
10	123 00 010 1	16,50 €	2
12	123 00 012 1	16,50 €	2

PE Kaynak Çubuğu

PE Welding Rods



Çap Dia	Kod Code	Fiyat (Adet) Price (Pcs)	Kg /Koli Kg/Box
3	124 00 003 1	18,00 €	5
4	124 00 004 1	18,00 €	5

PP Kaynak Çubuğu

PP Welding Rods



Çap Dia	Kod Code	Fiyat (Adet) Price (Pcs)	Kg /Koli Kg/Box
3	125 00 003 1	18,00 €	5
4	125 00 004 1	18,00 €	5

U-PVC Flaşlı Ön Filtre (Pislik Tutucu)

U-PVC Prefilters With Flange



d (mm)	Kod Code	Fiyat (Adet) Price (Pcs)	Koli/kg Box/kg	Koli /Adet Kg/Pcs	D (mm)	H (mm)
63	729 00 063 5	506,00 €	15,25	1	280	37
75	729 00 075 5	528,00 €	15,25	1	280	37
90	729 00 090 5	550,00 €	15,30	1	280	37
110	729 00 110 5	572,00 €	15,35	1	315	37
125	729 00 125 5	594,00 €	19,20	1	315	37
140	729 00 140 5	616,00 €	19,25	1	315	48
160	729 00 160 5	660,00 €	21,20	1	315	48

*Konfeksiyon / Hand-made

304 Paslanmaz Çelik Ön Filtre

304 Stainless Steel Prefilter



d (mm)	Kod Code	Fiyat (Adet) Price (Pcs)	Koli /Adet Kg/Pcs
75	729 01 075 5	1.100,00 €	1
90	729 01 090 5	1.230,00 €	1
110	729 01 110 5	1.350,00 €	1
140	729 01 140 5	1.840,00 €	1
160	729 01 160 5	2.144,00 €	1
225	729 01 225 5	3.030,00 €	1

PP Flaşlı Ön Filtre

PP Prefilters With Flange



d (mm)	Kod Code	Fiyat (€/Adet) Price (€/Pcs)	Koli /Adet Kg/Pcs
90-110	729 90 110 5	600,00 €	1

Hava Emiş Vanası (Vakum)

Air Suction Valve (Vacuum)



d (mm)	Kod Code	Fiyat (Adet) Price (Pcs)	Kg /Adet Kg/Pcs	Koli/Adet Box/Pcs
1" Tek Hareket (Step)	729 02 032 2	82,14 €		30
2" Tek Hareket (Step)	729 02 063 2	149,60 €		14
1" Çift Hareketli (Double Steps)	729 12 032 2	82,14 €		30
2" Çift Hareketli (Double Steps)	729 12 063 2	149,60 €		14

Hava Purjörü

Air Reliff Cock



Kod Code	Fiyat (Adet) Price (Pcs)	Kg /Adet Kg/Pcs	Koli/Adet Box/Pcs
729 02 000 0	5,40 €	10,80 €	1

Manometre

Manometer



d (mm)	Kod Code	Fiyat (Adet) Price (Pcs)	Kg /Adet Kg/Pcs	Koli/Adet Box/Pcs
3 bar	729 02 000 3	37,34 €		1
10 bar	729 02 001 0	48,00 €		1

Tesisat Keteni (1.Kalite)

Flax Fiber (First Quality)



Kod Code	Fiyat (Adet) Price (Pcs)	Çuval/kg Sack/Kg
70006606	1.484,80 €	25
70006603	2.969,60 €	50

Teflon Bant

Teflon Tape



Çap Dia	Kod Code	Fiyat (Adet) Price (Pcs)	Koli Adet Box Pcs
12x10	70006800	3,50 €	1000
12x20	70006801	6,20 €	1000
19x50	70006802	8,92 €	250

Not / Note

U-PVC

CONTALI EK PARÇALAR GASKET SOCKETED FITTINGS

ÜRETİM STANDARDI
PRODUCTION STANDARD | EN 1452-3

ÇAP / SIZE Ø63 - Ø400

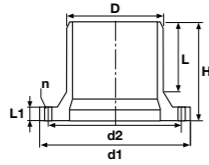

U-PVC Flanlı Manşon M
 U-PVC Flange Socket M

Çap Dia	Basınç PN	Kod Code	Fiyat (Adet) Price (Pcs)	Kg /Adet Kg/Pcs	Koli/Adet Box/Pcs	d1 (mm)	d2 (mm)	H (mm)	L (mm)	L1 (mm)	Q-n (mm)
63	10	611 00 063 4	41,20 €	0,53	42	125	165	110	80	16	17,5 x 4
75	10	611 00 075 4	43,42 €	0,67	25	145	185	130	85	16	17,5 x 4
90	10	611 00 090 4	51,50 €	1,03	15	160	200	153	115	20	17,5 x 8
110	10	611 00 110 4	55,40 €	1,28	10	180	225	167	125	21	17,5 x 8
160	10	611 00 160 4	98,96 €	2,54	8	240	285	196	146	25	22 x 8
200	10	611 00 200 4	181,44 €	4,20	4	295	336	215	166	32	22 x 8
225	10	611 00 225 4	267,60 €	4,75	2	295	340	226	170	31	22 x 8
250	10	611 00 250 4	283,04 €	6,25	2	350	395	257	180	33	22 x 12
315	10	611 00 315 4	428,50 €	9,45	2	400	445	297	200	36	22 x 12
355	10	611 00 355 4	624,00 €	-	2	445-460	505			38	22 x 16
400	10	611 00 400 4	664,12 €	13,10	2	495-515	565	303	235	41	26 x 16

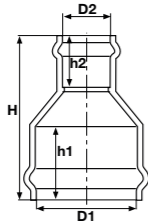
U-PVC Geçme Muflu Redüksiyonlu Manşon F/F
 U-PVC Reducing Socket With Rubber-Ring F/F

Çap Dia	Basınç PN	Kod Code	Fiyat (Adet) Price (Pcs)	Kg /Adet Kg/Pcs	Koli/Adet Box/Pcs	H (mm)	Z (mm)	h1 (mm)	h2 (mm)
90 - 63	10	612 00 090063 4	40,76 €	0,66	28	304	128	115	76
90 - 75	10	612 00 090075 4	44,20 €	0,82	22	304	153	115	81
110 - 63	10	612 00 110063 4	46,80 €	0,90	18	340	141	122	76
110 - 90	10	612 00 110090 4	50,28 €	1,41	16	340	197	122	115
160 - 110	10	612 00 160110 4	110,96 €	2,31	8	430	220	142	122
200 - 110	10	612 00 200110 4	130,04 €	3,50	4	477	235	155	122
200 - 160	10	612 00 200160 4	138,70 €	3,93	4	535	255	155	142
225 - 110	10	612 00 225110 4	156,60 €	3,93	4	492	250	166	122
225 - 160	10	612 00 225160 4	164,72 €	4,48	4	545	270	166	142
225 - 200	10	612 00 225200 4	173,38 €	5,25	2				
250 - 110	10	612 00 250110 4	199,40 €	5,00	4	516	265	180	122
250 - 160	10	612 00 250160 4	208,06 €	5,30	4	576	285	180	142
250 - 200	10	612 00 250200 4	216,72 €	6,15	2	618	315	180	155
250 - 225	10	612 00 250225 4	225,38 €	6,25	2				
315 - 110	10	612 00 315110 4	①	-	2	570	312	198	122
315 - 160	10	612 00 315160 4	433,44 €	8,75	2	618	317	198	142
315 - 200	10	612 00 315200 4	476,76 €	9,25	2	658	344	198	155
355 - 160	10	612 00 355160 4	①	-	2	616	343	206	142
355 - 200	10	612 00 355200 4	627,60 €	11,50	2	616	387	206	155
355 - 225	10	612 00 355225 4	①	-	1	664	370	206	166
355 - 250	10	612 00 355250 4	①	-	1	664	413	206	117

UH-PVC

YAPIŞTIRMA MUFLU EK PARÇALAR SOLVENT CEMENT FITTINGS

ÜRETİM STANDARDI
PRODUCTION STANDARD | EN 1452-3

ÇAP / SIZE Ø20 - Ø400



UH-PVC 90° Yapıştırma Muflu Dirsek
 UH-PVC 90° Solvent Cement Elbow

d (mm)	Basınç PN	Kod Code	Fiyat (Adet) Price (Pcs)	Kg /Adet Kg/Pcs	Koli/Adet Box/Pcs	DN	L (mm)	Z (mm)
20	16	500 00 020 2	0,23 €	0,01	400	15	16	11
25	16	500 00 025 2	0,28 €	0,02	200	20	18,5	13,5
32	16	500 00 032 2	0,42 €	0,02	100	25	22	17
40	16	500 00 040 2	0,81 €	0,05	60	32	26	21
50	16	500 00 050 2	0,82 €	0,09	80	40	31	26
63	16	500 00 063 2	1,03 €	0,18	60	50	38	32,5
75	16	500 00 075 2	1,97 €	0,31	40	65	43,5	38,5
90	16	500 00 090 2	2,73 €	0,42	25	80	51	46
110	16	500 00 110 2	4,62 €	0,75	15	100	61	56
125	16	500 00 125 2	7,21 €	1,15	8	110	68,5	63,5
140	16	500 00 140 2	10,67 €	1,53	6	125	76	71
160	16	500 00 160 2	13,81 €	2,25	4	150	86	81
200	16	500 00 200 2	33,61 €	4,65	2	175	106	101
225	10	500 00 225 2	48,95 €	4,83	1	200	118,5	114
250	10	500 00 250 4	123,20 €	6,97	1	250	131	131
280	10	500 00 280 4	192,50 €	8,55	1	250	146	141
315	10	500 00 315 4	217,80 €	12,3	1	300	163,5	163
355	10	500 00 355 4	645,46 €	17,5	1	350	183,5	184
400	10	500 00 400 4	646,87 €	23,5	1	400	206	206

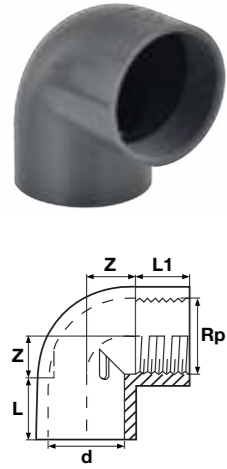
UH-PVC 90° Tek Tarafı İçten Dişli Dirsek
 UH-PVC 90° One Side Female Threaded Elbow

d-Rp Inch	Basınç PN	Kod Code	Fiyat (Adet) Price (Pcs)	Kg /Adet Kg/Pcs	Koli/Adet Box/Pcs	DN	Z (mm)	L (mm)	L1 (mm)
20 x 1/2"	16	500 10 020 2	0,30 €	0,02	303	15	11	16	14
25 x 3/4"	16	500 10 025 2	0,36 €	0,02	200	20	14	18,5	15,5
32 x 1"	16	500 10 032 2	0,55 €	0,04	100	25	17	22	21
40 x 1 1/4"	16	500 10 040 2	1,05 €	0,05	60	32	21	26	23
50 x 1 1/2"	16	500 10 050 2	1,07 €	0,09	80	40	26	31	25
63 x 2"	16	500 10 063 2	1,34 €	0,19	60	50	33	38	29,5
75 x 2 1/2"	16	500 10 075 2	2,56 €	0,41	40	65	38,5	43,5	30
90 x 3"	16	500 10 090 2	3,55 €	0,51	25	80	46	51	33
110 x 4"	16	500 10 110 2	6,01 €	1,00	15	100	56	61	39

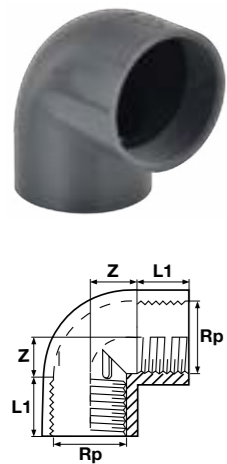
UH-PVC 90° Çift Tarafı İçten Dişli Dirsek
 UH-PVC 90° Both Sides Female Threaded Elbow

Rp Inch	Basınç PN	Kod Code	Fiyat (Adet) Price (Pcs)	Kg /Adet Kg/Pcs	Koli/Adet Box/Pcs	DN	L1 (mm)	Z (mm)
1/2"	16	500 20 020 2	0,35 €	0,02	303	15	14	11
3/4"	16	500 20 025 2	0,42 €	0,02	200	20	16,5	14
1"	16	500 20 032 2	0,63 €	0,04	100	25	21	17
1 1/4"	16	500 20 040 2	1,22 €	0,05	60	32	23	21
1 1/2"	16	500 20 050 2	1,23 €	0,09	80	40	25	26
2"	16	500 20 063 2	1,55 €	0,19	60	50	29,5	33
2 1/2"	16	500 20 075 2	2,96 €	0,42	40	65	30	38,5
3"	16	500 20 090 2	4,10 €	0,55	25	80	33	46
4"	16	500 20 110 2	6,93 €	1,05	15	100	39	56

UH-PVC 90° Yapıştırma Muflu Redüksiyonlu Dirsek
 UH-PVC 90° PRO-FIT Elbow

d (mm)	d1 (mm)	Basınç PN	Kod Code	Fiyat (Adet) Price (Pcs)	Kg /Adet Kg/Pcs	Koli/Adet Box/Pcs	L (mm)	L1 (mm)	Z (mm)	Z1 (mm)	Z2 (mm)
50	40	16	501 00 050040 2	2,30 €	0,12	80	57	67	26	36	41
63	50	16	501 00 063050 2	2,37 €	0,23	40	71	83	33	45	52

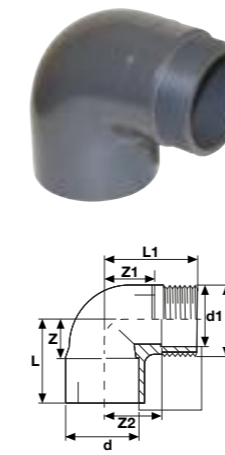
UH-PVC 90° Redüksiyonlu Dış Diş Dirsek
 UH-PVC 90° PRO-FIT Male Threaded Elbow

d (mm)	Rp (Inch)	Basınç PN	Kod Code	Fiyat (Adet) Price (Pcs)	Kg /Adet Kg/Pcs	Koli/Adet Box/Pcs	d1 (mm)	L (mm)	L1 (mm)	Z (mm)	Z1 (mm)	Z2 (mm)
50	1 1/2"	10	501 10 050040 2	2,91 €	1,00	80	40	57	67	26	36	41
63	2"	10	501 10 063050 2	4,12 €	1,00	40	50	71	83	33	45	52

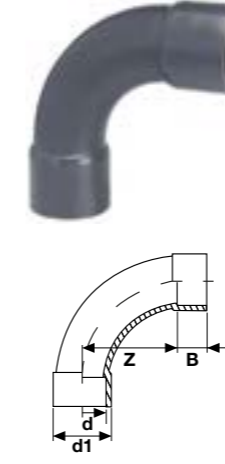
UH-PVC 90° Deve Boynu Dirsek (İç Dış Yapıştırma)
 UH-PVC 90° Solvent Cement Short Bend

d (mm)	Basınç PN	Kod Code	Fiyat (Adet) Price (Pcs)	Kg /Adet Kg/Pcs	Koli/Adet Box/Pcs	d1 (mm)	Z (mm)	B (mm)
50	16	501 00 050050 2	6,96 €	0,27	25	63	100	31
63	16	501 00 063063 2	8,72 €	0,51	20	75	126	38
75	16	501 00 075075 2	16,85 €	0,78	15	90	150	44
90	16	501 00 090090 2	24,68 €	1,33	10	110	180	51
110	16	501 00 110110 2	39,27 €	2,96	5	125	220	61

*U-PVC Borudan Konfeksiyon / U-PVC Hand-made from pipe

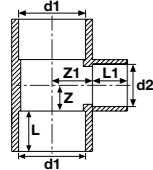
UH-PVC Yapıştırma Muflu İnegal Te
 UH-PVC Solvent Cement Reducing Tee

d1 (mm)	d2 (mm)	Basınç PN	Kod Code	Fiyat (Adet) Price (Pcs)	Kg/Adet Kg/Pcs	Koli/Adet Box/Pcs	DN1 (mm)	DN2 (mm)	L (mm)	L1 (mm)	Z1 (mm)	Z (mm)
32	20	16	508 00 032020 2	0,83 €	0,08	50	25	15	22	16	17	14
32	25	16	508 00 032025 2	0,76 €	0,08	100	25	20	22	16	17	14
32	50	16	508 00 032050 2	1,89 €	0,11	80	25	40	22	16	17	14
40	20	16	508 00 040020 2	1,25 €	0,13	48	32	15	26	16	23	17
40	25	16	508 00 040025 2	1,18 €	0,13	48	32	20	26	18,5	23	17
40	32	16	508 00 040032 2	1,06 €	0,13	48	32	25	26	22	23	17
50	20	16	508 00 050020 2	1,45 €	0,14	75	40	15	31	16	28	17
50	25	16	508 00 050025 2	1,45 €	0,14	75	40	20	31	18,5	28	17
50	32	16	508 00 050032 2	1,26 €	0,14	75	40	25	31	18,5	28	17
50	40	16	508 00 050040 2	1,24 €	0,14	50	40	32	31	22	28	17
63	25	16	508 00 063025 2	2,48 €	0,24	40	40	15	38	26	28	23
63	32	16	508 00 063032 2	2,51 €	0,24	30	50	25	38	18,5	35	23
63	40	16	508 00 063040 2	2,36 €	0,25	30	50	32	38	22	35	23
63	50	16	508 00 063050 2	2,31 €	0,29	30	50	40	38	26	35	23
75	32	16	508 00 075032 2	3,15 €		30	65	25	43,5	22	38,5	17
*75	40	16	508 00 075040 2	3,15 €		30	65	32	43,5	26	38,5	23
*75	50	16	508 00 075050 2	3,20 €		30	65	40	43,5	31	38,5	28
75	63	16	508 00 075063 2	3,26 €	0,45	30	65	50	43,5	31	38,5	28
*90	32	16	508 00 090032 2	4,46 €		35	80	25	51	22	46	17
*90	40	16	508 00 090040 2	4,46 €		35	80	32	51	26	46	23
*90	50	16	508 00 090050 2	4,52 €		35	80	40	51	31	46	28
90	63	16	508 00 090063 2	4,57 €	0,64	35	80	50	51	38	46	35
90	75	16	508 00 090075 2	4,73 €	0,66	25	80	65	51	38	46	35
*110	32	16	508 00 110032 2	6,49 €		22	100	25	61	22	56	17
*110	40	16	508 00 110040 2	6,49 €		22	100	32	61	26	56	23
110	50	16	508 00 110050 2	6,55 €		22	100	40	61	31	56	28
110	63	16	508 00 110063 2	6,60 €	0,75	22	100	50	61	43,5	56	40
110	75	16	508 00 110075 2	6,82 €	0,93	10	100	65	61	38	56	35
110	90	16	508 00 110090 2	7,15 €	0,98	11	100	80	61	43,5	56	40
125	63	16	508 00 125063 2	14,21 €	1,26	10	110	50	68,5	51	64	46
*125	75	16	508 00 125075 2	14,04 €	1,71	10	110	65	68,5	38	64	35
125	90	16	508 00 125090 2	13,33 €	1,58	8	110	80	68,5	43,5	64	40
125	110	16	508 00 125110 2	11,83 €	1,59	8	110	100	68,5	51	64	46
*140	63	16	508 00 140063 2	19,90 €	2,53	8	125	50	76	61	72	56
*140	75	16	508 00 140075 2	19,77 €	2,54	6	125	65	76	38	72	35
*140	90	16	508 00 140090 2	19,48 €	2,53	6	125	80	76	43,5	72	40
140	110	16	508 00 140110 2	17,82 €	2,27	6	125	100	76	51	72	46
*160	63	16	508 00 160063 2	24,08 €	2,69	5	150	50	86	61	81	56
*160	75	16	508 00 160075 2	22,70 €	2,70	5	150	65	86	38	81	35
*160	90	16	508 00 160090 2	22,00 €	2,69	5	150	80	86	43,5	81	40
160	110	16	508 00 160110 2	20,90 €	2,43	5	150	100	86	51	81	46
*160	125	16	508 00 160125 2	23,95 €	4,15	5	150	110	86	61	81	56
*200	75	16	508 00 200075 2	38,25 €	4,30	2	175	65	106	68,5	107	69
*200	90	16	508 00 200090 2	37,96 €	4,29	2	175	80	106	43,5	107	40
200	110	16	508 00 200110 2	36,30 €	4,03	2	175	100	106	51	107	46
*200	125	16	508 00 200125 2	40,01 €	5,25	2	175	110	106	61	107	82
*200	140	16	508 00 200140 2	38,17 €	4,96	2	175	125	106	68,5	107	82
200	160	16	508 00 200160 2	35,75 €	4,40	2	175	150	106	76	107	82
225	110	16	508 00 225110 2	60,06 €	4,32	2	200	100	118,5	86	120	82
*225	125	16	508 00 225125 2	65,16 €	5,43	2	200	110	118,5	61	120	56
*225	140	16	508 00 225140 2	63,33 €	5,14	2	200	125	118,5	68,5	120	69
225	160	16	508 00 225160 2	60,91 €	4,58	2	200	150	118,5	76	120	72
*225	200	10	508 00 225200 2	74,25 €	4,80	2	200	175	118,5	86	120	82
250	110	10	508 00 250110 2	110,74 €	7,75	1	250	100	131	106	132	107
*250	140	10	508 00 250140 2	115,83 €	7,85	1	250	125	131	61	132	132
250	160	10	508 00 250160 2	111,87 €	7,95	1	250	150	131	76	132	132
250	200	10	508 00 250200 2	113,50 €	8,15	1	250	175	131	86	132	132
*250	225	10	508 00 250225 2	156,15 €	10,56	1	250	200	131	106	132	132
280	110	10	508 00 280110 5	264,00 €		1	215	100	146	118,5	146	132
*280	140	10	508 00 280140 5	263,12 €		1	250	125	146	61	146	146
280	160	10	508 00 280160 5	260,70 €		1	250	150	146	76	146	146
*280	200	10	508 00 280200 5	243,65 €		1	250	175	146	86	146	146
280	225	10	508 00 280225 5	235,40 €		1	250	200	146	106	146	146
*280	250	10	508 00 280250 5	234,25 €		1	250	250	146	118,5	146	146
315	110	10	508 00 315110 5	223,27 €	14,2	1	300	100	146	131	146	146
315	160	10	508 00 315160 2	223,27 €	13,5	1	300	150	163,5	61	168	168
315	225	10	508 00 315225 2	216,95 €	14,1	1	300	200	163,5	86	168	168
*315	250	10	508 00 315250 2	302,50 €	22,3	1	300	250	163,5	118,5	168	168
*315	280	10	508 00 315280 2	280,50 €	19,9	1	300	250	163,5	131	168	168
*355	280	10	508 00 355280 5	916,00 €	33,5	1	350	250	163,5	146	168	168
*355	315	10	508 00 355315 5	847,00 €	30,1	1	350	300	183,5	146	196	152
*400	280	10	508 00 400280 5	1.430,10 €	46,5	1	400	250	183,5	163,5	196	175
*400	315	10	508 00 400315 5	1.361,10 €	43,0	1	400	300	206	146	214	152
*400	355	10	508 00 400355 5	1.234,10 €	36,6	1	400	350	206	163,5	214	175

*Redüksiyon ile düşürülmüştür/Reduced with reducer.

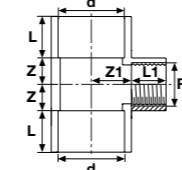
UH-PVC Tek Taraf İçten Dişli İnegal Te
 UH-PVC One Side Female Threaded Reducing Tee

d (mm)	Rp (Inch)	Basınç PN	Kod Code	Fiyat (Adet) Price (Pcs)	Kg /Adet Kg/Pcs	Koli/Adet Box/Pcs	DN (mm)	L (mm)	L1 (mm)	Z1 (mm)	Z (mm)
50	1"	16	508 10 050032 2	1,64 €	0,14	75	40	31	21	18	26
63	1"	16	508 10 063032 2	3,26 €	0,24	40	50	38	21	18	32,5
63	1 1/2"	16	508 10 063050 2	3,00 €	0,29	30	50	38	25	26	32,5
75	2"	16	508 10 075063 2	4,23 €	0,47	35	65	44	29,5	26	40
90	2"	16	508 10 090063 2	5,94 €	0,66	25	75	51	29,5	32,5	46
90	2 1/2"	16	508 10 090075 2	7,52 €	0,68	22	75	51	30	32,5	46
110	2"	16	508 10 110063 2	8,19 €	0,77	10	100	61	29,5	40	52
110	2 1/2"	16	508 10 110075 2	9,77 €	0,95	11	100	61	30	32,5	52
110	3"	16	508 10 110090 2	8,87 €	1,00	10	100	61	33	56	52

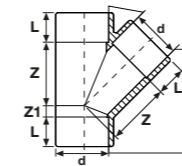
UH-PVC 45° Yapıştırma Muflu Te (Çatal)
 UH-PVC 45° Solvent Single Branch Tee

d (mm)	Basınç PN	Kod Code	Fiyat (Adet) Price (Pcs)	Kg /Adet Kg/Pcs	Koli/Adet Box/Pcs	Z (mm)	Z1 (mm)	L (mm)
*20	16	507 00 020 4	0,70 €			27	6	16
*25	16	507 00 025 4	0,75 €			33	7	18,5
*32	16	507 00 032 4	1,10 €			42	8	22
*40	16	507 00 040 4	1,25 €			51	10	26
50	16	507 00 050 4	1,48 €	0,12	20	53	12	31
63	16	507 00 063 4	1,98 €	0,23	20	79	14	38
*75	16	507 00 075 4	3,60 €		25	94	17	43,5
*90	16	507 00 090 4	5,40 €		20	122	20	51
110	16	507 00 110 4	8,60 €	1,41	8	137	24	61

*U-PVC Borudan Konfeksiyon / U-PVC Hand-made from pipe

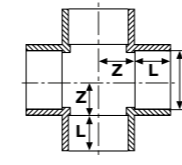
UH-PVC 90° Yapıştırma Muflu Kruva (İstavroz)
 UH-PVC 90° Solvent Cement Cross

d (mm)	Basınç PN	Kod Code	Fiyat (Adet) Price (Pcs)	Kg /Adet Kg/Pcs	Koli/Adet Box/Pcs	DN	L (mm)	Z (mm)
32	16	506 00 032 2	2,50 €	0,09	110	25	22	17
40	16	506 00 040 2	2,99 €	0,14	70	32	26	21
50	16	506 00 050 2	3,47 €	0,22				

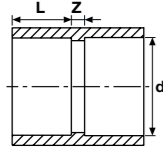
UH-PVC Yapıştırma Muflu Manşon
 UH-PVC Double Socket

d (mm)	Basınç PN	Kod Code	Fiyat (Adet) Price (Pcs)	Kg /Adet Kg/Pcs	Koli/Adet Box/Pcs	DN	L (mm)	Z (mm)
16	16	511 00 016 2	0,27 €	0,01	500	12	14	3
20	16	511 00 020 2	0,17 €	0,01	480	15	16	3
25	16	511 00 025 2	0,21 €	0,02	250	20	18,5	3
32	16	511 00 032 2	0,24 €	0,01	125	25	22	3
40	16	511 00 040 2	0,40 €	0,03	140	32	26	3
50	16	511 00 050 2	0,41 €	0,06	70	40	31	3
63	16	511 00 063 2	0,64 €	0,11	120	50	38	3
75	16	511 00 075 2	1,30 €	0,17	90	65	43,5	4
90	16	511 00 090 2	1,64 €	0,30	40	80	51	5
110	16	511 00 110 2	2,77 €	0,48	28	100	61	6
125	16	511 00 125 2	3,60 €	0,7	22	110	68,5	6
140	16	511 00 140 2	4,25 €	0,9	16	125	76	8
160	16	511 00 160 2	6,36 €	1,3	12	150	86	8
200	16	511 00 200 2	14,30 €	2,15	3	175	106	8
225	16	511 00 225 2	22,94 €	3,79	2	200	118,5	10
250	10	511 00 250 4	39,16 €	4	1	250	131	12
280	10	511 00 280 5	62,00 €	7,6	1	250	146	12
315	10	511 00 315 5	76,89 €	6,98	1	300	163,5	14
355	10	511 00 355 5	294,91 €	13,9	1	350	183,5	68
400	10	511 00 400 5	322,08 €	11,6	1	400	206	73

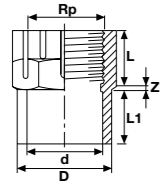
UH-PVC Tek Taraf İçten Dişli Redüksiyonlu Adaptör
 UH-PVC One Side Female Threaded Reducer Adaptor

d (mm)	Rp (Inch)	Basınç PN	Kod Code	Fiyat (Adet) Price (Pcs)	Kg /Adet Kg/Pcs	Koli/Adet Box/Pcs	D (mm)	L (mm)	L1 (mm)	Z (mm)
20	1/2"	16	518 00 020 2	0,25 €	0,01	450	25	12	16	5,5
25	3/4"	16	518 00 025 2	0,28 €	0,02	240	32	16	22	1,5
32	1"	16	518 00 032 2	0,32 €	0,03	180	40	19	27	1,5
40	1 1/4"	16	518 00 040 2	0,63 €	0,06	80	50	22	27	5
50	1 1/2"	16	518 00 050 2	0,89 €	0,13	100	63	19	38	9,5
63	2"	16	518 00 063 2	1,26 €	0,17	75	75	24	39	6

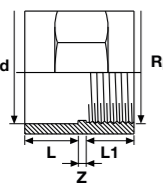

d (mm)	Rp (Inch)	Basınç PN	Kod Code	Fiyat (Adet) Price (Pcs)	Kg /Adet Kg/Pcs	Koli/Adet Box/Pcs	L (mm)	L1 (mm)	Z (mm)
75	2 1/2"	16	519 00 075 2	1,94 €	0,24	75	44	32	7
90	3"	16	519 00 090 2	2,42 €	0,31	60	52	36	9
110	4"	16	519 00 110 2	3,89 €	0,47	18	61	40	9
125	4 1/2"	16	519 00 125 5	9,68 €	0,86	22	69	44	40
140	5"	16	519 00 140 5	10,37 €	1,06	16	75	44	40
160	6"	10	519 00 160 5	15,57 €	1,56	12	86	50	50
*200	7"	10	519 00 200 5	39,83 €	2,34	4	106	55	50
*225	8"	10	519 00 225 5	62,11 €	3,09	2	120	60	55
*250	9"	10	519 00 250 5	73,71 €	3,90	2	131	60	55

*Konfeksiyon / Hand-made

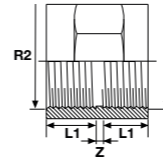
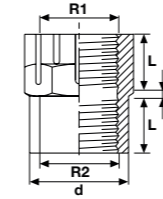
UH-PVC Çift Tarafı İçten Dişli Redüksiyonlu Adaptör
 UH-PVC Both Sides Female Threaded Reducer Adaptor

d (mm)	R1-R2 (inch)	Basınç PN	Kod Code	Fiyat (Adet) Price (Pcs)	Kg /Adet Kg/Pcs	Koli/Adet Box/Pcs	L (mm)	Z (mm)
25	1/2"	16	518 10 020 2	0,38 €	0,01	450	12	5,5
32	3/4"	16	518 10 025 2	0,42 €	0,02	240	16	1,5
40	1"	16	518 10 032 2	0,48 €	0,03	180	19	1,5
50	1 1/4"	16	518 10 040 2	0,95 €	0,06	80	22	5
*63	1 1/2"	16	518 10 050 2	1,34 €	0,15	100	19	9,5
*75	2"	16	518 10 063 2	1,89 €	0,15	75	24	6

*Konfeksiyon / Hand-made

R1 (inch)	R2 (inch)	Basınç PN	Kod Code	Fiyat (Adet) Price (Pcs)	Kg /Adet Kg/Pcs	Koli/Adet Box/Pcs	L1 (mm)	Z (mm)
75	2 1/2"	16	519 10 075 2	2,92 €		75	32	7
90	3"	16	519 10 090 2	3,62 €		60	36	9
110	4"	16	519 10 110 2	5,83 €		18	40	9

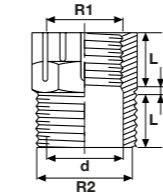
UH-PVC Tek Taraf Dış Diş Tek Taraf İç Diş Redüksiyonlu Adaptör
 UH-PVC One Side Female Other Side Male Threaded Adaptor

R1 Inch	R2 Inch	Basınç PN	Kod Code	Fiyat (Adet) Price (Pcs)	Kg /Adet Kg/Pcs	Koli/Adet Box/Pcs	L (mm)	Z (mm)
1 1/4"	1 1/2"	16	518 20 040 2	0,95 €	0,04	80	22	5
1 1/2"	1 1/2"	16	518 20 050 2	1,42 €	0,07	150	19	9,5
*2 1/2"	2"	16	508 20 050 2	1,34 €	0,09	95	19	9,5
*2"	2"	16	518 20 063 2	2,13 €	0,10	160	24	6
2"	2 1/2"	16	518 20 063 3	1,89 €	0,14	75	24	6
2 1/2"	3"	16	518 20 075 2	2,92 €		75	32	7
4"	4 1/2"	16	518 20 110 2	5,83 €		18	36	9

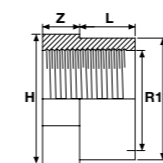
UH-PVC Dış Y.M. İç Diş Redüksiyonlu Adaptör
 UH-PVC One Side Female Threaded Reducer Adaptor

d (mm)	R1 Inch	Basınç PN	Kod Code	Fiyat (Adet) Price (Pcs)	Kg /Adet Kg/Pcs	Koli/Adet Box/Pcs	L (mm)	Z (mm)	H (mm)
32	3/4"	16	518 20 025 2	0,42 €	0,01	550	12	8	28
40	1"	16	518 20 032 2	0,48 €	0,01	250	14,4	9	35
50	1 1/4"	16	518 21 040 2	0,84 €	0,02	180	16,8	9	44
63	1 1/2"	16	518 20 063 2	2,13 €	0,06	120	21,1	12	68

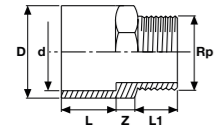
UH-PVC Tek Taraf Dıştan Dişli Redüksiyonlu Adaptör
 UH-PVC One Side Male Threaded Reducer Adaptor

d (mm)	Rp Inch	Basınç PN	Kod Code	Fiyat (Adet) Price (Pcs)	Kg /Adet Kg/Pcs	Koli/Adet Box/Pcs	D (mm)	L (mm)	L1 (mm)	Z (mm)
20	1/2"	16	522 00 020 2	0,24 €	0,01	400	25	16	15	10
25	3/4"	16	522 00 025 0	0,30 €	0,02	250	32	19	16	11
32	1"	16	522 00 032 2	0,35 €	0,03	160	40	22	19	11
40	1 1/4"	16	522 00 040 2	0,74 €	0,06	120	50	26	21	14
50	1 1/2"	16	522 00 050 2	0,95 €	0,10	150	63	31	22	8
63	2"	16	522 00 063 2	1,42 €	0,16	100	75	38	27	9
75	2 1/2"	16	522 00 075 2	1,94 €	0,24	48	90	44	30	16
90	3"	16	522 00 090 2	3,31 €	0,44	27	110	51	33	20
110	4"	16	522 00 110 2	4,25 €	0,47	26	125	61	39	19

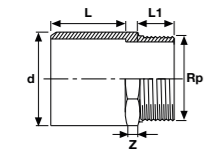
UH-PVC Dış Dişli Dıştan Yapıştırılabilir Adaptör (Uzun Tip)
 UH-PVC Male Threaded Adaptor (Long Type)

d (mm)	Rp Inch	Basınç PN	Kod Code	Fiyat (Adet) Price (Pcs)	Kg /Adet Kg/Pcs	Koli/Adet Box/Pcs	L (mm)	L1 (mm)	Z (mm)
50	1 1/2"	16	524 00 050 2	0,96 €	0,09	125	60,0	22,0	14
63	2"	16	524 00 063 2	1,31 €	0,14	70	70,0	30,0	15
75	2 1/2"	16	524 00 075 2	2,26 €	0,22	80	87,0	30,0	15
90	3"	16	524 00 090 2	3,31 €	0,37	40	108,0	35,0	15
110	4"	16	524 00 110 2	3,78 €	0,45	30	94,0	40,0	30
* 125	4 1/2"	16	524 00 125 2	10,14 €	1,02	14	126,0	44,0	40
* 140	5"	16	524 00 140 2	11,84 €	0,95	12	126,0	44,0	40
* 160	6"	16	524 00 160 2	16,25 €	1,14	8	111,0	50,0	50
* 200	7"	10	524 00 200 2	39,88 €	1,65	6	172,0	80,0	50

*Konfeksiyon / Hand-made

UH-PVC Yapıştırma Muflu Dış Dişli Adaptör

UH-PVC Male Threaded Adaptor Solvent Cemented

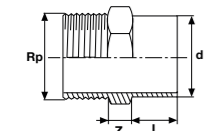

d (mm)	Rp Inch	Basınç PN	Kod Code	Fiyat (Adet) Price (Pcs)	Kg /Adet Kg/Pcs	Koli/Adet Box/Pcs	L (mm)	Z (mm)
50	1 1/2"	16	521 00 050 2	0,92 €	0,11	150	22	14
63	2"	16	521 00 063 2	1,16 €	0,12	140	27	15

UH-PVC Çift Taraf Dış Diş Redüksiyonlu Adaptör

UH-PVC Both Sides Male Threaded Reducer Adaptor

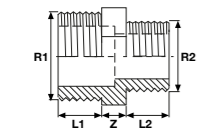

R1 Inch	R2 Inch	Basınç PN	Kod Code	Fiyat (Adet) Price (Pcs)	Kg /Adet Kg/Pcs	Koli/Adet Box/Pcs	L1 (mm)	L2 (mm)	Z (mm)
3/4"	1/2"	16	522 10 020 2	0,45 €	0,01	500	13	12	8
1"	3/4"	16	522 10 025 2	0,53 €	0,01	300	14	13	8
1 1/4"	1"	16	522 10 032 2	1,05 €	0,02	179	16	14	9
1 1/2"	1"	16	522 12 032 2	1,42 €	0,03	150	17	14	9
1 1/2"	1 1/4"	16	522 10 040 2	1,42 €	0,08	149	17	16	9
2"	1"	16	522 11 032 2	2,13 €	0,12	70	23	21	12
2"	1 1/4"	16	522 11 040 2	2,13 €	0,16	105	23	16	12
2"	1 1/2"	16	522 10 050 2	2,13 €	0,27	70	23	17	12
2 1/2"	1 1/4"	16	522 11 050 2	2,92 €	0,08	75	24	17	12
2 1/2"	2"	16	522 10 063 2	2,92 €	0,08	105	24	21	12
3"	2"	16	522 11 063 2	4,97 €	0,12	35	26	21	14
3"	2 1/2"	16	522 10 075 2	4,97 €	0,27	48	26	24	14
4"	2 1/2"	16	522 12 075 2	6,38 €	0,16	35	32	24	16
4"	2"	16	522 12 063 2	6,38 €	0,27	35	32	21	16
4"	3"	16	522 10 090 2	6,38 €	0,03	45	32	26	16

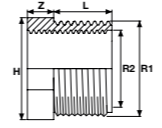
UH-PVC Tek Taraf Dış Diş Tek Taraf İç Diş Redüksiyonlu Adaptör
 UH-PVC One Side Female Other Side Male Threaded Reducer Adaptor

R1 Inch	R2 Inch	Basınç PN	Kod Code	Fiyat (Adet) Price (Pcs)	Kg /Adet Kg/Pcs	Koli/Adet Box/Pcs	L (mm)	Z (mm)	H (mm)
25	1/2"	16	518 20 040 3	0,44 €	0,01	550	12	8	28
32	3/4"	16	518 20 050 3	0,50 €	0,01	250	14,4	9	35
40	1"	16	518 21 050 3	0,84 €	0,02	180	16,8	9	44
63	2 1/2"	16	518 20 063 3	1,68 €	0,06	120	21,1	12	64

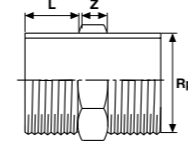
UH-PVC Nipel
 UH-PVC Barrel Nipel

Rp Inch	Basınç PN	Kod Code	Fiyat (Adet) Price (Pcs)	Kg /Adet Kg/Pcs	Koli/Adet Box/Pcs	L (mm)	Z (mm)
1/2"	16	520 00 020 2	0,33 €	0,08	800	16,0	8,0
3/4"	16	520 00 025 2	0,37 €	0,11	500	18,0	10,0
1"	16	520 00 032 2	0,44 €	0,18	250	22,0	12,0
1 1/4"	16	520 00 040 2	0,69 €	0,32	180	23	14
1 1/2"	16	520 00 050 2	0,81 €	0,43	150	26	14
2"	16	520 00 063 2	1,06 €	0,083	120	21	12
2 1/2"	16	520 00 075 2	1,75 €	0,124	75	24	12
3"	16	520 00 090 2	2,45 €	0,171	70	26	14
4"	16	520 00 110 2	2,73 €	0,278	45	32	16
4 1/2"	16	520 00 125 5	10,08 €	0,626	20	44,0	40,0
5"	16	520 00 140 5	11,31 €	0,752	10	44,0	50,0
6"	16	520 00 160 5	16,68 €	1,6	10	50,0	50,0
7"	10	520 00 200 5	23,61 €	1,955	4	55,0	50,0

UH-PVC Dış Dişli Hortum Adaptörü

UH-PVC One Side Male Threaded Hose Adaptor

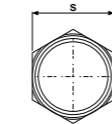
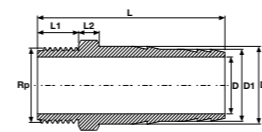

d (mm)	Basınç PN	Kod Code	Fiyat (Adet) Price (Pcs)	Kg /Adet Kg/Pcs	Koli/Adet Box/Pcs	Rp (mm)	D (mm)	D1 (mm)	D2 (mm)	L (mm)	L1 (mm)	L2 (mm)	S (mm)
20	16	525 00 020 2	0,33 €	0,01	400	1/2"	15	20,4	22	62	15	8	22
25	16	525 00 025 2	0,55 €	0,03	225	3/4"	20	25,4	28	72	16	8	28
32	16	525 00 032 2	0,66 €	0,04	140	1"	25	31,4	34	82	18	9	34
40	16	525 00 040 2	1,96 €	0,05	150	1 1/4"	32	40,4	43	95	21	13	43
50	16	525 00 050 2	2,27 €	0,08	125	1 1/2"	40	50	53	104	21	14	53
63	16	525 00 063 2	2,54 €	0,14	70	2"	50	60	66	123	26	16	66
75	16	525 00 075 2	3,68 €	0,21	80	2 1/2"				132	30		
90	16	525 00 090 2	5,20 €	0,35	40	3"				158	35		
*110	16	525 00 110 2	6,20 €	0,40	30	4"				164	40		
*125	16	525 00 125 5	15,36 €		20	4 1/2"				210	43		
*140	16	525 00 140 5	16,52 €		12	5"				210	43		
*160	16	525 00 160 5	24,18 €	1,22	8	6"				211	45		

UH-PVC Dıştan Yapıştırılabilir Hortum Adaptörü

UH-Pvc Solvent Cement Hose Adaptor (External Connection)

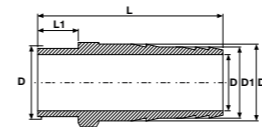

d (mm)	Basınç PN	Kod Code	Fiyat (Adet) Price (Pcs)	Kg /Adet Kg/Pcs	Koli/Adet Box/Pcs	Rp (mm)	D (mm)	D1 (mm)	D2 (mm)	L (mm)	L1 (mm)
20	16	528 80 020 2	0,33 €	0,01	400	1/2"	20	20	22	55	16
25	16	528 80 025 2	0,55 €	0,03	225	3/4"	25	25	28	67	19
32	16	528 80 032 2	0,66 €	0,04	140	1"	32	31	34	77	22
40	16	528 80 040 2	1,96 €	0,05	150	1 1/4"	40	40	43	87	26
50	16	528 80 050 2	2,27 €	0,08	125	1 1/2"	50	50	53	100	31
63	16	528 80 063 2	2,54 €	0,14	70	2"	63	60	66	119	38

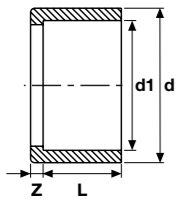
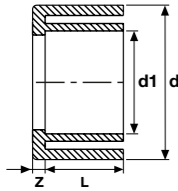
UH-PVC Yapıştırma Muflu Redüksiyon
 UH-PVC Solvent Cement Reducer

d (mm)	d1 (mm)	Basınç PN	Kod Code	Fiyat (Adet) Price (Pcs)	Kg /Adet Kg/Pcs	Koli/Adet Box/Pcs	L (mm)	Z (mm)
20	16	16	509 00 020016 2	0,18 €	0,004	1500	14	2
25	20	16	509 00 025020 2	0,11 €	0,004	1000	16	3
32	20	16	509 00 032020 2	0,18 €	0,01	500	16	7
32	25	16	509 00 032025 2	0,11 €	0,01	500	18,5	4
40	20	16	509 00 040020 2	0,38 €	0,02	300	16	10
40	25	16	509 00 040025 2	0,26 €	0,02	300	18,5	7
40	32	16	509 00 040032 2	0,15 €	0,01	300	22	4
50	32	16	509 00 050032 2	0,37 €	0,03	200	22	9
50	40	16	509 00 050040 2	0,30 €	0,02	200	26	5
63	32	16	509 00 063032 2	0,65 €	0,07	100	22	16
63	40	16	509 00 063040 2	0,78 €	0,07	100	26	11
63	50	16	509 00 063050 2	0,47 €	0,05	100	31	6,5
75	40	16	509 00 075040 2	1,00 €	0,08	60	26	17,5
75	50	16	509 00 075050 2	0,68 €	0,09	60	31	13
75	63	16	509 00 075063 2	0,46 €	0,07	60	38	6
90	32	16	509 00 090032 2	1,51 €	0,13	65	22	25
90	50	16	509 00 090050 2	1,25 €	0,14	70	31	20
90	63	16	509 00 090063 2	0,81 €	0,14	70	38	13
90	75	16	509 00 090075 2	0,67 €	0,13	70	43,5	8
110	50	16	509 00 110050 2	1,98 €	0,25	40	31	30
110	63	16	509 00 110063 2	1,98 €	0,26	40	38	23
110	75	16	509 00 110075 2	1,86 €	0,27	40	44	17
110	90	16	509 00 110090 2	1,59 €	0,26	40	51	10
125	63	16	509 00 125063 2	3,47 €	0,40	25	38	31
125	75	16	509 00 125075 2	3,36 €	0,42	25	43,5	25
125	90	16	509 00 125090 2	2,64 €	0,38	25	51	18
125	110	16	509 00 125110 2	1,51 €	0,25	25	61	7,5
140	63	16	509 00 140063 2	5,61 €	0,525	35	38	40
140	75	16	509 00 140075 2	5,28 €	0,5	35	43,5	33
140	90	16	509 00 140090 2	4,13 €	0,49	35	51	25
140	110	16	509 00 140110 2	2,74 €	0,50	33	61	15
140	125	16	509 00 140125 2	1,84 €	0,294	25	68,5	7,5
160	90	16	509 00 160090 2	6,27 €	0,70	12	51	35
160	110	16	509 00 160110 2	4,51 €	0,76	15	61	25
160	140	16	509 00 160140 2	2,42 €	0,56	15	76	10
200	160	16	509 00 200160 2	6,88 €	1,22	12	86	20
225	200	16	509 00 225200 2	8,25 €	1,34	6	106	13
*250	200	16	509 00 250200 2	28,00 €	2,98	6	106	25,5
250	225	16	509 00 250225 2	19,75 €	1,64	6	118,5	12,5
280	250	16	509 00 280250 2	25,25 €	2,43	2	131	16
315	280	16	509 00 315280 2	37,95 €	3,54	2	146	17
*355	280	16	509 00 355 280 5	169,05 €	10,40	1	146	44
355	315	16	509 00 355315 5	109,53 €	6,41	1	163,5	27
*400	280	16	509 00 400280 5	388,20 €	18,9	1	146	67
*400	315	16	509 00 400315 5	328,69 €	14,9	1	163,5	50
400	355	16	509 00 400355 5	219,15 €	8,53	1	183,5	23

*Redüksiyon ile düşürülmüştür. / Reduced with reducer.

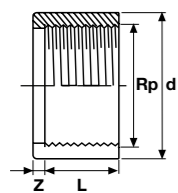
UH-PVC İçten Dişli Redüksiyon
 UH-PVC Female Threaded Reducer

d (mm)	Rp Inch	Basınç PN	Kod Code	Fiyat (Adet) Price (Pcs)	Kg /Adet Kg/Pcs	Koli/Adet Box/Pcs	L (mm)	Z (mm)
25	1/2"	16	509 10 025020 2	0,22 €	0,004	1200	16	3
32	1/2"	16	509 10 032020 2	0,36 €	0,01	600	16	7
40	3/4"	16	509 10 040025 2	0,53 €	0,02	300	20	7
40	1"	16	509 10 040032 2	0,29 €	0,01	300	20	6
50	1"	16	509 10 050032 2	0,36 €	0,03	200	25	6
50	1 1/4"	16	509 10 050040 2	0,74 €	0,02	200	23	9
63	1"	16	509 10 063032 2	1,30 €	0,07	100	22	16
63	1 1/2"	16	509 10 063050 2	0,92 €	0,05	100	30	8
75	1 1/2"	16	509 10 075050 2	1,37 €	0,09	30	31	13
75	2"	16	509 10 075063 2	0,91 €	0,07	30	36	8
90	2"	16	509 10 090063 2	1,62 €	0,14	65	38	13
90	2 1/2"	16	509 10 090075 2	1,33 €	0,13	65	43	8
110	2"	16	509 10 110063 2	3,96 €	0,26	75	38	23
110	2 1/2"	16	509 10 110075 2	1,61 €	0,27	75	44	17
110	3"	16	509 10 110090 2	3,17 €	0,26	75	50	10

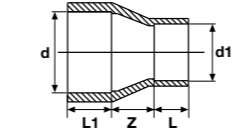
UH-PVC Yapıştırma Muflu Konik Redüksiyon
 UH-PVC Solvent Cement Conical Reducer

d (mm)	d1 (mm)	Basınç PN	Kod Code	Fiyat (Adet) Price (Pcs)	Kg /Adet Kg/Pcs	Koli/Adet Box/Pcs	Z (mm)	L (mm)	L1 (mm)
160	110	16	510 00 160110 2	12,65 €	1,27	12	40	61	86
225	110	16	510 00 225110 2	24,07 €	2,64	3	41,5	61	118,5
225	160	16	510 00 225160 2	24,39 €	2,66	3	41,5	86	118,5
400	250	16	510 00 400250 2	364,56 €	10,5	1	50	131	206
400	355	16	510 00 400355 2	474,58 €	11,5	1	51	183,5	206

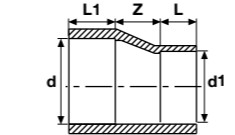
UH-PVC Yapıştırma Muflu Eksantrik Redüksiyon
 UH-PVC Solvent Cement Excentric Reducer

d (mm)	d1 (mm)	Basınç PN	Kod Code	Fiyat (Adet) Price (Pcs)	Kg /Adet Kg/Pcs	Koli/Adet Box/Pcs	Z (mm)	L (mm)	L1 (mm)
250	200	16	510 00 250 200 2	35,78 €	3,37	2	37,8	106,5	131
250	225	16	510 00 250 225 2	37,98 €	3,38	2	24,5	119,5	131

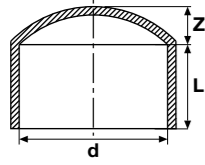

UH-PVC Yapıştırma Muflu Kör Tapa
 UH-PVC Solvent Cement End Cap

d (mm)	Basınç PN	Kod Code	Fiyat (Adet) Price (Pcs)	Kg /Adet Kg/Pcs	Koli/Adet Box/Pcs	DN	L (mm)	Z (mm)
20	16	516 00 020 2	0,18 €	0,008	700	15	16	5,5
25	16	516 00 025 2	0,22 €	0,01	600	20	18,5	7
32	16	516 00 032 2	0,28 €	0,02	350	25	22	8,5
40	16	516 00 040 2	0,35 €	0,04	250	32	26	10
50	16	516 00 050 2	0,53 €	0,05	100	40	31	12
63	16	516 00 063 2	0,63 €	0,08	100	50	38	16
75	16	516 00 075 2	1,07 €	0,17	60	65	43,5	18
90	16	516 00 090 2	1,37 €	0,34	35	80	51	20
110	16	516 00 110 2	2,00 €	0,34	25	100	61	24
125	16	516 00 125 2	3,41 €	0,46	15	110	68,5	26
140	16	516 00 140 2	4,29 €	0,82	10	125	76	30
160	16	516 00 160 2	7,81 €	1,16	8	150	86	38
200	16	516 00 200 2	12,43 €	1,46	8	175	106	44
225	16	516 00 225 2	20,90 €	2,31	6	200	118,5	50
250	10	516 00 250 2	31,90 €	2,87	2	250	131	55
280	10	516 00 280 2	45,10 €	4,81	2	250	146	60
315	10	516 00 315 2	59,40 €	5,87	1	300	163,5	64
355	10	516 00 355 4	217,00 €	9,30	1	350	183,5	67
400	10	516 00 400 4	319,78 €	16,2	1	400	206	71
*450	10	516 00 450 5	560,00 €	-	1	-	-	-
*500	10	516 00 500 5	670,00 €	-	1	-	-	-

*Konfeksiyon / Hand-made

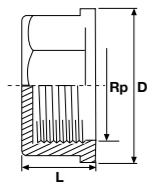
UH-PVC İçten Dişli Kör Tapa
 UH-PVC Female Threaded Cap

d (mm)	Rp Inch	Basınç PN	Kod Code	Fiyat (Adet) Price (Pcs)	Kg /Adet Kg/Pcs	Koli/Adet Box/Pcs	L (mm)	D (mm)
20	1/2"	16	517 00 020 2	0,39 €	0,01	700	19,5	26
25	3/4"	16	517 00 025 2	0,52 €	0,08	600	20,5	31
32	1"	16	517 00 032 2	0,65 €	0,024	250	24	39
40	1 1/4"	16	517 00 040 2	0,79 €	0,027	150	26,5	51
50	1 1/2"	16	517 00 050 2	1,16 €	0,082	210	27	56
63	2"	16	517 00 063 2	1,68 €	0,067	100	33,5	70
75	2 1/2"	16	517 00 075 2	2,89 €	0,23	60	40	88
90	3"	16	517 00 090 2	4,04 €	0,2	35	44	102
110	4"	16	517 00 110 2	5,20 €	0,29	25	50	128

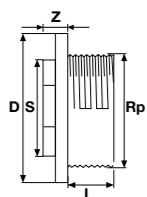
UH-PVC Dıştan Dişli Kör Tapa
 UH-PVC Solvent Cement Threaded Plug

Rp Inch	Basınç PN	Kod Code	Fiyat (Adet) Price (Pcs)	Kg /Adet Kg/Pcs	Koli/Adet Box/Pcs	D (mm)	L (mm)	Z (mm)	S (mm)
2"	16	523 00 063 2	1,31 €	0,06	100	75	31	12	65
2 1/2"	16	523 00 075 2	2,57 €	0,11	60	90	34	16	94
4"	16	523 00 110 2	6,09 €	0,2	30	110	40	17	138

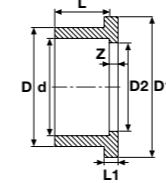
UH-PVC Yapıştırma Muflu Kole
 UH-PVC Solvent Cement Flange Adaptor

d mm	Basınç PN	Kod Code	Fiyat (Adet) Price (Pcs)	Kg /Adet Kg/Pcs	Koli/Adet Box/Pcs	DN1 (mm)	D (mm)	D1 (mm)	L (mm)	L1 (mm)	Z (mm)
16	16	512 00 016 2	0,75 €	0,012	600	12	22	34,0	14,0	7	3
20	16	512 00 020 2	0,55 €	0,009	750	15	27	34,0	16,0	7	3
25	16	512 00 025 2	0,55 €	0,01	450	20	33	41,0	19,0	7	3
32	16	512 00 032 2	0,70 €	0,02	250	25	41	50,0	22,0	7	3
40	16	512 00 040 2	0,83 €	0,04	150	32	50	61,0	26,0	8	3
50	16	512 00 050 2	0,83 €	0,06	160	40	60	73,0	31,0	8	3
63	16	512 00 063 2	0,85 €	0,09	100	50	77	91,0	38,0	9	3
75	16	512 00 075 2	1,05 €	0,16	70	65	90	106,0	43,5	10	3
90	16	512 00 090 2	1,37 €	0,23	85	80	107	125,0	51,0	11	5
110	16	512 00 110 2	2,17 €	0,41	45	100	129	150,0	61,0	12	5
125	16	512 00 125 2	3,03 €	0,60	24	110	147	170,0	69,0	13	5
140	16	512 00 140 2	3,96 €	0,78	18	125	164	188,0	76,0	14	5
160	16	512 00 160 2	5,81 €	1,10	16	150	188	213,0	86,0	16	5
200	16	512 00 200 2	8,16 €	1,45	7	175	230	255,0	106,0	18	6
225	16	512 00 225 2	8,86 €	2,06	3	200	245	274,0	120,0	24	6
250	10	512 00 250 2	36,30 €	2,75	4	250	269	303,0	131,0	20	9
280	10	512 00 280 2	37,40 €	3,05	2	250	304	329,0	146,0	20	5
315	10	512 00 315 2	54,45 €	3,95	2	300	341	346,0	164,0	20	8
355	10	512 00 355 5	232,87 €	5,7	1	350	384	430,0	184,0	28	10
400	4	512 00 400 4	255,00 €	7,05	1	400	450	482,0	206,0	25	10
450	4	512 00 450 5	650,00 €	-	1	-	-	-	-	-	-
500	4	512 00 500 5	770,00 €	-	1	-	-	-	-	-	-

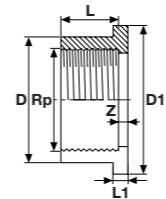
UH-PVC İçten Dişli Kole
 UH-PVC Female Threaded Flange Adaptor

Rp Inch	Basınç PN	Kod Code	Fiyat (Adet) Price (Pcs)	Kg /Adet Kg/Pcs	Koli/Adet Box/Pcs	DN (mm)	D (mm)	D1 (mm)	L (mm)	L1 (mm)	Z (mm)
*3/8"	16	512 02 016 2	1,25 €	0,01	600	12	27	34,0	14,0	7	3
1/2"	16	512 02 020 2	0,95 €	0,01	750	15	27	34,0	16,0	7	3
3/4"	16	512 02 025 2	1,15 €	0,01	450	20	33	41,0	19,0	7	3
1"	16	512 02 032 2	1,35 €	0,02	250	25	41	50,0	22,0	7	3
1 1/4"	16	512 02 040 2	1,63 €	0,03	150	32	50	61,0	26,0	8	3
1 1/2"	16	512 02 050 2	2,10 €	0,07	160	40	60	73,0	35,0	8	3
2"	16	512 02 063 2	2,36 €	0,13	100	50	77	91,0	38,0	9	3
2 1/2"	16	512 02 075 2	4,15 €	0,12	60	65	90	106,0	43,0	10	3
3"	16	512 02 090 2	4,57 €	0,27	85	80	107	125,0	51,0	11	5
4"	16	512 02 110 2	5,25 €	0,35	45	100	129	150,0	60,0	12	5

*Konfeksiyon / Hand-made

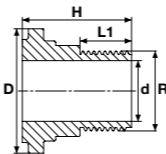
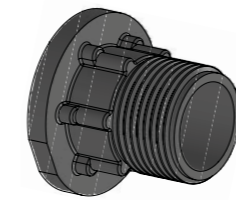
UH-PVC Dıştan Dişli Kole
 UH-PVC Male Threaded Flange Adaptor

d (mm)	Rp (mm)	Basınç PN	Kod Code	Fiyat (Adet) Price (Pcs)	Kg /Adet Kg/Pcs	Koli/Adet Box/Pcs	L1 (mm)	D (mm)	H (mm)
50	1 1/2"	16	229 06 050 2	1,04 €	0,09	50	25	62,5	52
63	2"	16	229 06 063 2	1,22 €	0,14	25	27	78	57,5
63	1 1/2"	16	229 07 063 2	1,17 €	0,12	25	32	106	68

UH-PVC Yapıştırma Flanşlı Manşon
UH-PVC Solvent Cement Flange Socket

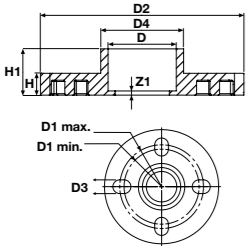

d (mm)	Basınç PN	Kod Code	Fiyat (Adet) Price (Pcs)	Koli/Adet Box/Pcs	D1 Min. (mm)	D1 Max. (mm)	D2 (mm)	D3 (mm)	D4 (mm)	N (Adet)	H (mm)	H1 (mm)	Z1 (mm)
*20	16	512 50 020 2	1,62 €		60,5	65	95	15,75	27	4	12	21,5	3
25	16	512 50 025 2	1,62 €		70	75	105	15,75	33	4	12	21,5	3
*32	16	512 50 032 2	1,90 €		79,2	85	115	15,75	41	4	14	25	3
*40	16	512 50 040 2	2,29 €		88,9	100	140	18	50	4	15	29	3
*50	16	512 50 050 2	2,29 €		98,6	110	150	18	61	4	16	34	3
63	16	512 50 063 2	2,46 €		120,6	124	165	19	76	4	18	40,5	3
75	16	512 50 075 2	3,15 €		139,7	145	185	19	90	4	19	46,5	3
90	16	512 50 090 2	3,70 €		152,4	160	200	19	108	8	20	56	5
110	16	512 50 110 2	4,61 €	10	180	190,5	220	19	131	8	22	66	5
125	16	512 50 125 2	6,42 €	8	210	-	250	19	148	8	26	73,5	5
140	16	512 50 140 2	7,27 €	8	210	-	250	19	165	8	26	81	5
160	16	512 50 160 2	10,23 €	12	240	-	285	22	188	8	28	91	5
200	16	512 50 200 2	17,71 €		295	-	340	22	224	8	36	111	5

*U-PVC Borudan Konfeksiyon / U-PVC Hand-made from pipe

UH-PVC Yapıştırma Muflu Serbest Flanş
UH-PVC Solvent Cement Flange

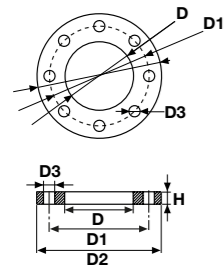

d (mm)	Basınç PN	Kod Code	Fiyat (Adet) Price (Pcs)	Kg /Adet Kg/Pcs	Koli/Adet Box/Pcs	Inch	DN (mm)	D (mm)	D1 (mm)	D2 (mm)	D3 (mm)	H (mm)	N (Adet)
20	16	513 00 020 2	1,15 €	0,10	150	1/2"	15	28	65	96	14	11	4
25	16	513 00 025 2	1,15 €	0,12	100	3/4"	20	34	75	105	14	12	4
32	16	513 00 032 2	1,30 €	0,18	80	1"	25	42	85	115	14	14	4
40	16	513 00 040 2	1,58 €	0,29	50	1 1/4"	32	51	100	140	14	15	4
50	16	513 00 050 2	1,58 €	0,23	48	1 1/2"	40	62	110	150	18	16	4
63	16	513 00 063 2	1,73 €	0,30	25	2"	50	78	125	165	18	18	4
75	16	513 00 075 2	2,26 €	0,40	40	2 1/2"	65	92	145	185	18	20	4
90	16	513 00 090 2	2,52 €	0,46	35	3"	80	111	160	200	18	22	8
110	16	513 00 110 2	2,68 €	0,53	22	4"	100	133	180	220	18	24	8
125	16	513 00 125 2	3,73 €	0,78	18	4 1/2"	110	150	210	250	18	26	8
140	16	513 00 140 2	3,69 €	0,74	18	5"	125	167	210	250	18	26	8
160	16	513 00 160 2	4,95 €	0,81	14	6"	150	193	250	285	22	28	8
200	16	513 00 200 2	9,55 €	1,67	8	7"	175	226	295	340	22	32	8
225	16	513 00 225 2	9,55 €	1,23	8	8"	200	257	295	340	22	32	8
250	16	513 00 250 2	46,20 €	2,19	7	9"	250	278	325	370	22	36	8
280	10	513 00 280 2	36,96 €	1,58	7	10"	250	310	350	395	22	36	12
315	10	513 00 315 2	46,89 €	2,96	7	12"	300	348	400	445	22	36	12
355	10	513 00 355 4	224,25 €		1	14"	350	388	460	505	22	38	16
400	10	513 00 400 4	337,83 €		1	16"	400	442	515	565	26	42	16
450	10	513 00 450 5	650,00 €		1								
500	10	513 00 500 5	780,00 €		1								

UH-PVC Tamir Flanş
UH-PVC Repair Flange

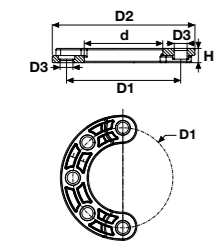

d (mm)	Basınç PN	Kod Code	Fiyat (€/Adet) Price (€/Pcs)	Kg /Adet Kg/Pcs	Koli/Adet Box/Pcs	D1 (mm)	D2 (mm)	D3 (mm)	H (mm)
90	10	513 16 090 2	4,79 €	0,430	35	160	200	18	20
110	10	513 16 110 2	4,81 €	0,535	22	180	220	18	22
125	10	513 16 125 2	7,08 €	0,820	18	210	250	18,5	25
140	10	513 16 140 2	7,00 €	0,725	18	210	250	18	25,5
160	10	513 16 160 2	9,41 €	0,950	14	240	285	22	28
200	10	513 16 200 2	18,14 €	1,450	11	295	340	22	30

UH-PVC Yapıştırma Muflu Kör Flanş
UH-PVC Solvent Cement Blind Flange

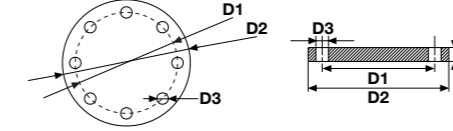

d mm	Inch	Basınç PN	Kod Code	Fiyat (Adet) Price (Pcs)	Kg /Adet Kg/Pcs	Koli/Adet Box/Pcs	DN (mm)	D1 (mm)	D2 (mm)	D3 (mm)	H (mm)	N (Adet)
20	1/2"	16	514 00 020 2	2,99 €	0,09	149	15	65	96	14	12	4
25	3/4"	16	514 00 025 2	3,59 €	0,14	110	20	75	105	14	13	4
32	1"	16	514 00 032 2	4,19 €	0,17	80	25	85	115	14	15	4
40	1 1/4"	16	514 00 040 2	5,03 €	0,28	50	32	100	140	14	16	4
50	1 1/2"	16	514 00 050 2	6,08 €	0,37	48	40	110	150	18	17	4
63	2"	16	514 00 063 2	6,71 €	0,57	25	50	125	165	18	20	4
75	2 1/2"	16	514 00 075 2	7,55 €	0,74	16	65	145	185	18	21	4
90	3"	16	514 00 090 2	8,18 €	0,85	14	80	160	200	18	22	8
110	4"	16	514 00 110 2	7,88 €	1,56	11	100	180	220	18	24	8
125	4 1/2"	16	514 00 125 2	10,62 €	1,62	18	125	210	250	18	28	8
140	5"	16	514 00 140 2	10,62 €	1,62	1	125	210	250	18	28	8
160	6"	16	514 00 160 2	14,85 €	2,58	18	150	250	285	22	28	8
200	7"	16	514 00 200 2	39,60 €	3,82	14	200	295	340	22	32	8
225	7"	16	514 00 225 2	39,60 €	3,82	8	200	295	340	22	32	8
250	8"	16	514 00 250 4	128,70 €		8	250	350	395	22	36	8
280	9"	10	514 00 280 4	128,70 €		8	250	350	395	22	36	12
315	10"	10	514 00 315 4	167,20 €		7	300	400	445	22	36	12
355	12"	10	514 00 355 4	469,20 €		7	350	460	505	22	38	16
400	14"	10	514 00 400 4	500,25 €		7	400	515	565	26	40	16
450	16"	10	514 00 450 5	1.120,00 €		7						
500		10	514 00 500 5	1.350,00 €		7						

UH-PVC Yapıştırma Muflu Flanş Takım
UH-PVC Solvent Cement Flange Set

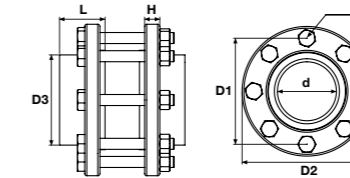

d (mm)	Inch	Basınç PN	Kod Code	Fiyat (Adet) Price (Pcs)	Kg /Adet Kg/Pcs	Koli/Adet Box/Pcs	DN (mm)	D1 (mm)	D2 (mm)	D3 (mm)	D4 (mm)	L (Adet)	H (mm)	N (Adet)
20	1/2"	16	513 07 020 2	11,62 €		16	15	65	96	27	14	17	11	4
25	3/4"	16	513 07 025 2	11,62 €		16	20	75	105	33	14	22	12	4
32	1"	16	513 07 032 2	12,22 €		16	25	85	115	41	14	25	14	4
40	1 1/4"	16	513 07 040 2	13,44 €		16	32	100	140	50	14	29	15	4
50	1 1/2"	16	513 07 050 2	13,44 €		16	40	110	150	60	18	34	16	4
63	2"	16	513 07 063 2	13,80 €	1,64	1	50	125	165	77	18	41	18	4
75	2 1/2"	16	513 07 075 2	15,56 €	2,06	1	65	145	185	90	18	46,5	20	4
90	3"	16	513 07 090 2	19,05 €	3,43	1	80	160	200	107	18	56	22	8
110	4"	16	513 07 110 2	22,24 €	3,90	1	100	180	220	129	18	66	24	8
125	4 1/2"	16	513 07 125 2	26,64 €	4,80	1	110	210	250	147	18	74	26	8
140	5"	16	513 07 140 2	28,84 €	5,30	1	125	210	250	164	18	81	26	8
160	6"	16	513 07 160 2	35,81 €	6,00	1	150	250	285	188	22	91	28	8
200	7"	16	513 07 200 2	55,42 €	8,60	1	175	295	340	230	22	112	32	8
225	8"	10	513 07 225 2	57,88 €	8,80	1	200	295	340	245	22	126	32	8
250	9"	10	513 07 250 2	189,71 €	13,50	1	250	325	370	269	22	140	36	8
280	10"	10	513 07 280 2	175,24 €	12,85	1	250	350	395	304	22	151	36	12
315	12"	10	513 07 315 2	236,54 €	15,80	1	300	400	445	341	22	172	36	12
355	14"	10	513 07 355 2	978,46 €		1	350	460	505	384	22	194	38	16
400	16"	10	513 07 400 2	1.271,28 €		1	400	515	565	450	26	216	42	16
*450	-	10	513 07 450 2	2.715,36 €		1	-	-	-	-	-	-	-	-
*500	-	10	513 07 500 2	3.255,36 €		1	-	-	-	-	-	-	-	-

*Konfeksiyon / Hand-made

UH-PVC Yapıştırma Muflu Beton Geçiş Flanşı

UH-PVC Solvent Cement Wall Cross Flange



d mm	Inch	Basınç PN	Kod Code	Fiyat (Adet) Price (Pcs)	Kg /Adet Kg/Pcs	Koli/Adet Box/Pcs	DN (mm)	E (mm)	L (mm)	Z (mm)
50	1 1/2"	16	515 00 050 2	0,26 €	0,03	200	40	80	26	4
63	2"	16	515 00 063 2	0,32 €	0,04	125	50	96	30	4
75	2 1/2"	16	515 00 075 2	0,47 €	0,06	90	65	111	30	4
90	3"	16	515 00 090 2	0,63 €	0,07	100	80	129	30	5
110	4"	16	515 00 110 2	0,71 €	0,08	80	100	149	30	5
125	4 1/2"	16	515 00 125 2	1,08 €	0,11	35	110	164	31	5
140	5"	16	515 00 140 2	1,10 €	0,12	33	125	180	31	5
160	6"	16	515 00 160 2	1,27 €	0,13	50	150	199	31	5
200	7"	16	515 00 200 2	1,65 €	0,13	25	175	245	20	6
*225	7"	10	515 00 225 2	8,80 €	0,16	10	200	308	41	6
*250	8"	10	515 00 250 5	12,10 €		7	250	272	57	8
*280	9"	10	515 00 280 5	19,58 €		6	250	329	70	8
*315	10"	10	515 00 315 5	23,10 €		5	300	346	80	9
*355	12"	10	515 00 355 5	56,92 €		5	350	430	92	9
*400	14"	10	515 00 400 5	75,90 €		5	400	482	103	9

*U-PVC Borudan Konfeksiyon. / U-PVC Hand-made from pipe

UH-PVC Somun

UH-PVC Male Threaded Nut



Rp Inch	Basınç PN	Kod Code	Fiyat (Adet) Price (Pcs)	Kg /Adet Kg/Pcs	Koli/Adet Box/Pcs	L (mm)	Z (mm)	s (mm)
1/2"	16	527 00 020 4	0,80 €	0,01	400	35	13	32
3/4"	16	527 00 025 4	0,80 €	0,01	400	39	13	32
1"	16	527 00 032 4	1,10 €	0,02	240	48	15	40
1 1/4"	16	527 00 040 4	1,68 €	0,02	300	58	17	50
1 1/5"	16	527 00 050 4	1,89 €	0,04	150	65	18	56
2"	16	527 00 063 4	2,84 €	0,04	140	79	21	69
*2 1/2"	16	527 00 075 4	5,36 €	0,06	25	94	23	85
*3"	16	527 00 090 4	6,72 €	0,10	20	112	26	100
*4"	16	527 00 110 4	8,19 €	0,16	2	160	36	147

*Konfeksiyon / Hand-made

UH-PVC Dış Dişli Parça

UH-PVC Male Threaded Piece



Rp Inch	Basınç PN	Kod Code	Fiyat (Adet) Price (Pcs)	Kg /Adet Kg/Pcs	Koli/Adet Box/Pcs	L (mm)
1/2"	16	526 00 020 5	2,95 €	0,01	400	60
3/4"	16	526 00 025 5	2,95 €	0,01	225	60
1"	16	526 00 032 5	2,95 €	0,02	140	80
1 1/4"	16	526 00 040 5	3,17 €	0,04	150	80
1 1/5"	16	526 00 050 5	10,40 €	0,06	125	80
2"	16	526 00 063 5	13,34 €	0,12	70	100
2 1/2"	16	526 00 075 5	20,90 €	0,21	80	120
3"	16	526 00 090 5	28,88 €	0,38	40	150
4"	10	526 00 110 5	36,23 €	0,50	30	150

UH-PVC Yapıştırma Muflu TYP-B Dıştan Dişli Depo Bağlantı Adaptörü (Uzun Tip)

UH-PVC Solvent Cement TYP-B Male Threaded Tank Adaptor (Long Type)



d1 (mm)	Basınç PN	Kod Code	Fiyat (Adet) Price (Pcs)	Kg /Adet Kg/Pcs	Koli/Adet Box/Pcs	d2 (mm)	d3 (mm)	Z1 (mm)	Z2 (mm)	B (mm)	C (mm)	D (mm)	S (mm)
20	10	528 00 020 5	4,52 €	0,03	20	3/4"	3/4"	13	0-23	16	17	42	32
25	10	528 00 025 5	4,52 €	0,05	10	1"	1"	15	0-23	19	21	45	40
32	10	528 00 032 5	4,52 €	0,10	40	1 1/4"	1 1/4"	17	0-26	22	23	49	50
40	10	528 00 040 5	4,75 €	0,22	50	1 1/2"	1 3/4"	19	0-21	26	23	48	60
50	10	528 00 050 5	13,82 €	0,25	50	2"	2"	21	0-21	31	27	52	69
50	10	528 01 050 5	①	0,38	50	2"	2 1/4"	21	0-21	31	27	52	76
63	10	528 00 063 5	18,96 €	0,37	20	2 1/2"	2 1/2"	23	0-23	38	31	53	85
75	10	528 00 075 5	31,50 €	0,59	5	3"	3"	26	0-20	44	34	56	100
90	10	528 00 090 5	42,00 €	0,69	10	4"	113"	32	0-20	51	40	62	125
*110	10	528 00 110 5	52,50 €	1,58	12								
*125	10	528 00 125 5	93,50 €	0,30	1								
*140	10	528 00 140 5	104,50 €	1,97	4								
*160	10	528 00 160 5	137,50 €		2								
*200	10	528 00 200 5	225,50 €		1								

*U-PVC Borudan Konfeksiyon. / U-PVC Hand-made from pipe

U-PVC Depo Bağlantı Adaptör Yaprak Contası EPDM

U-PVC Tank Adaptor EPDM Rubber Flat Gasket



Çap Dia	Kod Code	Fiyat (Adet) Price (Pcs)	Kg /Adet Kg/Pcs	Poşet/Adet Bag/Pcs
20	221 05 020 1	6,30 €	1,50	100
25	221 05 025 1	6,60 €	2,50	100
32	221 05 032 1	6,90 €	5,00	100
40	221 05 040 1	8,51 €	6,00	100
50	221 05 050 1	8,51 €	7,00	100
63	221 05 063 1	8,90 €	10,50	100
75	221 05 075 1	9,61 €	15,00	100
90	221 05 090 1	11,03 €	21,50	100
110	221 05 110 1	12,05 €	23,50	100

EPDM Yaprak Conta

EPDM Rubber Flat Gasket



Çap Dia	Kod Code	Fiyat (Adet) Price (Pcs)	Kg /Adet Kg/Pcs	Poşet/Adet Bag/Pcs
63	221 05 063 9	6,62 €	10,50	50
75	221 05 075 9	6,93 €	15,00	50
90	221 05 090 9	7,25 €	21,50	50
110	221 05 110 9	8,51 €	22,50	50
125	221 05 125 9	8,91 €	52,50	50
140	221 05 140 9	9,33 €	60,50	50
160	221 05 160 9	10,07 €		50
200	221 05 200 9	11,55 €		20
225	221 05 225 9	12,63 €		20
250	221 05 250 9	16,26 €		20
280	221 05 280 9	18,07 €		20
315	221 05 315 9	25,41 €		20
355	221 05 355 9	59,10 €		20
400	221 05 400 9	78,60 €		20

Not / Note

U-PVC

RAKOR

UNION

ÜRETİM STANDARDI
PRODUCTION STANDARD | EN 1452-3

ÇAP / SIZE Ø16 - Ø110



UH-PVC Rakor
UH-PVC Union

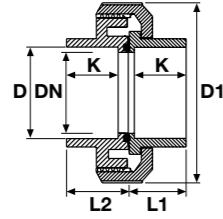

Su için / For Water

Asit için / For Acid

Çap Dia	Basınç PN	EPDM Conta Kod EPDM O-Ring Code	Fiyat (Adet) Price (Pcs)	FKM Conta Kod FKM O-Ring Code	Fiyat (Adet) Price (Pcs)	Kg /Adet Kg/Pcs	Koli/Ad. Box/Pcs	DN (mm)	D1 (mm)	L1 (mm)	L2 (mm)	K (mm)
16	16	227 00 016 2	1,85 €	227 55 016 2	2,40 €	0,05	125	12	53	19	24	16
20	16	227 00 020 2	1,35 €	227 55 020 2	1,75 €	0,05	125	15	54	19	24	16
25	16	227 00 025 2	1,90 €	227 55 025 2	2,47 €	0,07	100	20	62	22	27	19
32	16	227 00 032 2	2,60 €	227 55 032 2	3,38 €	0,09	50	25	65	25	30	22
40	16	227 00 040 2	2,85 €	227 55 040 2	3,70 €	0,16	30	32	83	28	36	26
50	16	227 00 050 2	3,90 €	227 55 050 2	5,07 €	0,189	45	40	93	38	42	31
63	16	227 00 063 2	4,60 €	227 55 063 2	5,98 €	0,35	30	50	116	41	52	38
75	16	227 00 075 2	12,00 €	227 55 075 2	15,60 €	0,585	18	65	129	47	54	44
90	16	227 00 090 2	16,50 €	227 55 090 2	21,45 €	0,98	12	80	155	56	61	51
110	16	227 00 110 2	21,50 €	227 55 110 2	28,00 €	1,47	7	100	178	66	71	61

UH-PVC Çift Taraf İçten Dişli Rakor
UH-PVC Both Sides Female Threaded Union

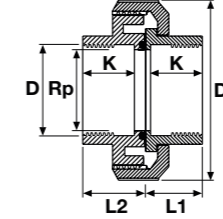

Su için / For Water

Asit için / For Acid

Rp (Inch)	Basınç PN	EPDM Conta Kod EPDM O-Ring Code	Fiyat (Adet) Price (Pcs)	FKM Conta Kod FKM O-Ring Code	Fiyat (Adet) Price (Pcs)	Kg /Adet Kg/Pcs	Koli/Ad. Box/Pcs	DN (mm)	D1 (mm)	L1 (mm)	L2 (mm)	K (mm)
3/8"	16	229 00 016 2	3,00 €	229 55 016 2	3,90 €	0,05	125	12	53	19	24	16
1/2"	16	229 00 020 2	2,50 €	229 55 020 2	3,25 €	0,05	125	15	54	19	24	16
3/4"	16	229 00 025 2	3,10 €	229 55 025 2	4,00 €	0,07	100	20	62	22	27	19
1"	16	229 00 032 2	4,10 €	229 55 032 2	5,30 €	0,09	50	25	65	25	30	22
1 1/4"	16	229 00 040 2	4,35 €	229 55 040 2	5,65 €	0,15	30	32	83	28	36	26
1 1/2"	16	229 00 050 2	5,90 €	229 55 050 2	7,67 €	0,25	45	40	93	38	42	31
2"	16	229 00 063 2	6,85 €	229 55 063 2	8,90 €	0,5	30	50	116	41	52	38
2 1/2"	16	229 00 075 2	14,20 €	229 55 075 2	18,46 €	0,61	18	65	129	47	54	44
3"	16	229 00 090 2	19,50 €	229 55 090 2	25,35 €	1,04	12	80	155	56	61	51
4"	16	229 00 110 2	24,90 €	229 55 110 2	32,37 €	1,415	7	100	178	66	71	61

UH-PVC Tek Taraf İçten Dişli Rakor
UH-PVC One Side Female Threaded Union

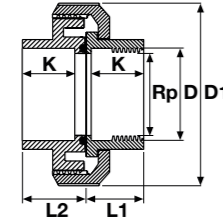

Su için / For Water

Asit için / For Acid

Çap Dia	Rp (Inch)	Basınç PN	EPDM Conta Kod EPDM O-Ring Code	Fiyat (Adet) Price (Pcs)	FKM Conta Kod FKM O-Ring Code	Fiyat (Adet) Price (Pcs)	Kg /Adet Kg/Pcs	Koli/Ad. Box/Pcs	DN (mm)	D1 (mm)	L1 (mm)	L2 (mm)	K (mm)
16	3/8"	16	228 00 016 2	2,50 €	228 55 016 2	3,25 €	0,05	125	12	53	19	24	16
20	1/2"	16	228 00 020 2	2,00 €	228 55 020 2	2,60 €	0,05	125	15	54	19	24	16
25	3/4"	16	228 00 025 2	2,60 €	228 55 025 2	3,38 €	0,07	100	20	62	22	27	19
32	1"	16	228 00 032 2	3,50 €	228 55 032 2	4,55 €	0,085	50	25	65	25	30	22
40	1 1/4"	16	228 00 040 2	3,80 €	228 55 040 2	4,94 €	0,155	30	32	83	28	36	26
50	1 1/2"	16	228 00 050 2	5,00 €	228 55 050 2	6,50 €	0,25	45	40	93	38	42	31
63	2"	16	228 00 063 2	6,00 €	228 55 063 2	7,80 €	0,48	30	50	116	41	52	38
75	2 1/2"	16	228 00 075 2	13,50 €	228 55 075 2	17,55 €	0,6	18	65	129	47	54	44
90	3"	16	228 00 090 2	18,00 €	228 55 090 2	23,40 €	1,005	12	80	155	56	61	51
110	4"	16	228 00 110 2	23,00 €	228 55 110 2	30,00 €	1,485	7	100	178	66	71	61

UH-PVC Pompa Rakoru Dış Diş
UH-PVC Male Threaded Union

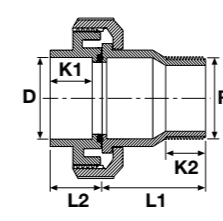

Su için / For Water

Asit için / For Acid

Çap Dia	Rp (Inch)	Basınç PN	EPDM Conta Kod EPDM O-Ring Code	Fiyat (Adet) Price (Pcs)	FKM Conta Kod FKM O-Ring Code	Fiyat (Adet) Price (Pcs)	Kg /Adet Kg/Pcs	Koli/Ad. Box/Pcs	DN (mm)	D1 (mm)	L1 (mm)	L2 (mm)	K1 (mm)	K2 (mm)
50	1 1/2"	16	230 00 050 2	4,10 €	230 55 050 2	5,33 €	0,23	50	40	50	81	45	31	22
63 x 50	1 1/2"	16	230 00 063 2	4,90 €	230 55 063 2	6,37 €	0,37	30	50	63	61	55	38	22
63	2"	16	230 01 063 2	4,95 €	230 56 063 2	6,45 €	0,39	25	50	63	72	55	38	27

UH-PVC Rakor Dış Dış Pirinç Çıkışlı
UH-PVC Union Outlet Male Brass Threaded

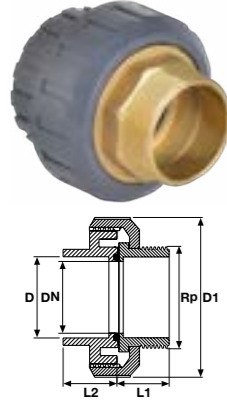

Çap Dia	Rp Inch	Basınç PN	EPDM Conta Kod EPDM O-Ring Code	Fiyat (Adet) Price (Pcs)	Kg /Adet Kg/Pcs	Koli/Adet Box/Pcs	DN (mm)	D1 (mm)	L1 (mm)	L2 (mm)
20	1/2"	16	242 30 020 2	4,14 €	0,105	125	15	15	19	25
25	3/4"	16	242 30 025 2	6,51 €		100	20	20	21	29
32	1"	16	242 30 032 2	8,66 €		50	25	25	25	32
40	1 1/4"	16	242 30 040 2	16,55 €	0,31	50	32	32	29	39
50	1 1/2"	16	242 30 050 2	22,34 €	0,455	30	40	40	34	45
63	2"	16	242 30 063 2	35,84 €	0,765	15	50	50	41	55

UH-PVC Çıkışlı Pirinç Rakor Dış Dişli
UH-PVC Outlet Brass Union Male Threaded

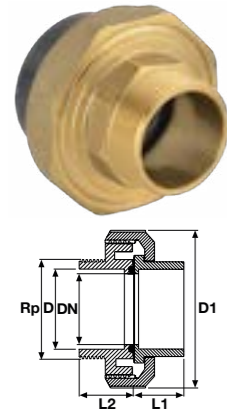

Çap Dia	Rp Inch	Basınç PN	EPDM Conta Kod EPDM O-Ring Code	Fiyat (Adet) Price (Pcs)	Kg /Adet Kg/Pcs	Koli/Adet Box/Pcs	DN (mm)	D1 (mm)	L1 (mm)	L2 (mm)
20	1/2"	16	242 00 020 2	5,01 €	0,08	125	15	36	19	14
25	3/4"	16	242 00 025 2	6,95 €	0,14	100	20	45	22	15
32	1"	16	242 00 032 2	8,90 €	0,17	50	25	51	25	17
40	1 1/4"	16	242 00 040 2	17,22 €	0,34	50	32	64	28	24
50	1 1/2"	16	242 00 050 2	25,91 €	0,52	30	40	80	38	22
63	2"	16	242 00 063 2	40,61 €	0,68	24	50	98	41	23

UH-PVC Rakor İç Dış Pirinç Çıkışlı
UH-PVC Union Outlet Female Brass Threaded

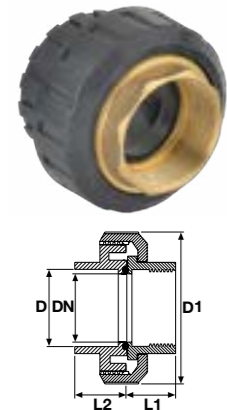

Çap Dia	R Inch	Basınç PN	EPDM Conta Kod EPDM O-Ring Code	Fiyat (Adet) Price (Pcs)	Kg /Adet Kg/Pcs	Koli/Adet Box/Pcs	DN (mm)	D1 (mm)	L1 (mm)	L2 (mm)
20	1/2"	16	242 20 020 2	3,75 €	0,09	125	15	36	19	14
25	3/4"	16	242 20 025 2	5,99 €	0,10	100	20	45	21	15
32	1"	16	242 20 032 2	7,74 €	0,15	50	25	51	25	17
40	1 1/4"	16	242 20 040 2	14,04 €	0,32	50	32	64	29	24
50	1 1/2"	16	242 20 050 2	19,86 €	0,39	30	40	80	34	22
63	2"	16	242 20 063 2	31,25 €	0,66	10	50	98	41	23

UH-PVC Çıkışlı Pirinç Rakor İç Dişli
UH-PVC Outlet Brass Union Female Threaded

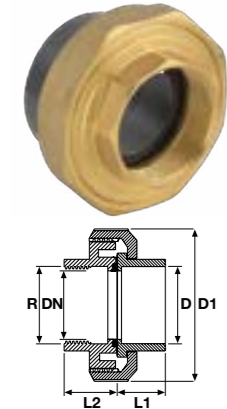

Çap Dia	R Inch	Basınç PN	EPDM Conta Kod EPDM O-Ring Code	Fiyat (Adet) Price (Pcs)	Kg /Adet Kg/Pcs	Koli/Adet Box/Pcs	DN (mm)	D1 (mm)	L1 (mm)	L2 (mm)
20	1/2"	16	242 10 020 2	4,59 €	0,07	50	15	36	19	14
25	3/4"	16	242 10 025 2	6,42 €	0,10	100	20	45	22	15
32	1"	16	242 10 032 2	7,98 €	0,15	90	25	51	25	17
40	1 1/4"	16	242 10 040 2	17,90 €	0,28	80	32	64	28	24
50	1 1/2"	16	242 10 050 2	23,42 €	0,41	30	40	80	38	22
63	2"	16	242 10 063 2	39,68 €	0,77	24	50	98	41	23

UH-PVC Gözetleme Camı
UH-PVC Inspection Glass

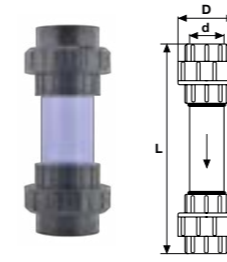

Çap Dia	Basınç PN	EPDM Conta Kod EPDM O-Ring Code	Fiyat (Adet) Price (Pcs)	Kg /Adet Kg/Pcs	Koli/Adet Box/Pcs	DN (mm)	D (mm)	L (mm)
20	10	231 00 020 2	15,40 €	0,13	100	15	51	205
25	10	231 00 025 2	16,80 €	0,18	100	20	57	219
32	10	231 00 032 2	18,20 €	0,31	50	25	67	230
40	10	231 00 040 2	19,60 €	0,43	50	32	82	244
50	10	231 00 050 2	21,00 €	0,53	30	40	88	272
63	10	231 00 063 2	23,80 €	0,91	25	50	107	368
75	10	231 00 075 2	60,20 €	1,39	10	63	131	320
90	10	231 00 090 2	81,20 €	2,27	5	80	147	351
110	10	231 00 110 2	89,60 €		2	100	176	420

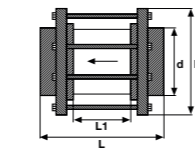

Çap Dia	Basınç PN	EPDM Conta Kod EPDM O-Ring Code	Fiyat (Adet) Price (Pcs)	Kg /Adet Kg/Pcs	Koli/Adet Box/Pcs	DN (mm)	D1 (mm)	L (mm)	L1 (mm)	nQe
125	10	231 00 125 2	112,00 €	6,29	1	110	250	254	110	8-Q16
140	10	231 00 140 2	126,00 €	6,75	1	125	250	265	110	8-Q16
160	10	231 00 160 2	189,00 €	10,7	2	150	285	315	110	8-Q20
200	10	231 00 200 2	224,00 €	14,5	1	175	340	315	80	8-Q20
225	10	231 00 225 2	266,00 €	14,7	1	200	340	315	80	8-Q20

Flanş Bağlantılı / With Flange

UH-PVC Seviye Göstergesi
UH-PVC Variable Area Flow Meter

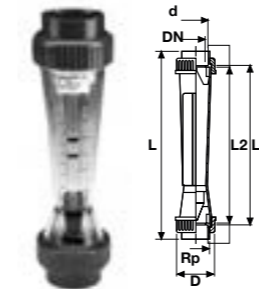

Çap Dia (Inch)	Rp (Inch)	EPDM Conta Kod EPDM O-Ring Code	Fiyat (Adet) Price (Pcs)	Kg/Adet Kg/Pcs	Koli/Adet Box/Pcs	DN (mm)	D (mm)	L (mm)	L1 (mm)	L2 (mm)	ScaleRange (l/h)	Type
32	1"	231 00 900 4	343,00 €	0,41	1	25	60	385	341	335	50 - 500	SK 10
32	1"	231 00 902 4	343,00 €	0,41	1	25	60	385	341	335	100 - 1000	SK 11
32	1"	231 00 734 4	343,00 €	0,41	1	25	60	385	341	335	150 - 1500	SK 12
50	1 1/2"	231 00 738 4	457,00 €	1,02	1	40	83	403	341	335	200 - 2000	SK 18
50	1 1/2"	231 00 741 4	457,00 €	1,02	1	40	83	403	341	335	250 - 2500	SK 19
50	1 1/2"	231 00 904 4	457,00 €	1,02	1	40	83	403	341	335	300 - 3000	SK 20
50	1 1/2"	231 00 906 4	457,00 €	1,02	1	40	83	403	341	335	600 - 6000	SK 21
63	2"	231 00 744 4	732,00 €	1,38	1	50	103	417	341	335	600 - 6000	SK 29
63	2"	231 00 908 4	732,00 €	1,38	1	50	103	417	341	335	1000 - 10000	SK 30
63	2"	231 00 910 4	732,00 €	1,38	1	50	103	417	341	335	1500 - 15000	SK 31
75	2 1/2"	231 00 330 4	1,138,00 €	2,15	1	65	122	457	342	335	2000 - 20000	SK 40
75	2 1/2"	231 00 332 4	1,138,00 €	2,15	1	65	122	457	342	335	3000 - 30000	SK 41

UH-PVC Temizleme Y. Filtresi
UH-PVC Line Strainer (Transparent Body)



Çap Dia	Basınç PN	EPDM Conta Kod EPDM O-Ring Code	Fiyat (Adet) Price (Pcs)	Kg/Adet Kg/Pcs	Koli/Adet Box/Pcs	DN (mm)	D (mm)	L (mm)	L1 (mm)	L2 (mm)
20	10	231 00 300 4	22,00 €	0,11	1	15	43	124	130	28
25	10	231 00 350 4	27,00 €	0,17	1	20	47	144	150	37
32	10	231 00 400 4	33,20 €	0,22	1	25	56	154	160	37
40	10	231 00 450 4	46,91 €	0,38	1	32	64	174	180	44
50	10	231 00 500 4	63,20 €	0,63	1	40	82	194	200	48
63	10	231 00 550 4	86,00 €	1,05	1	50	95	224	230	60
75	10	231 00 600 4	153,17 €	1,83	1	65	106	284	290	74
90	10	231 00 650 4	193,44 €	2,56	1	80	120	300	310	85

Metal Körüklü Kompansatörler / Hareketli Flanş (30 mm Layersiz)
 Metal Bellows Compensator / Moving Flange (30 mm Without Liner)

Çap Dia	Kod Code	Fiyat (Adet) Price (Pcs)	Kg /Adet Kg/Pcs
40	120 12 040 8	75,00 €	
50	120 12 050 8	80,00 €	3,79
63	120 12 063 8	85,00 €	4,80
75	120 12 075 8	103,00 €	5,60
90	120 12 090 8	124,00 €	
110	120 12 110 8	155,00 €	8,20
140	120 12 140 8	180,00 €	9,80
160	120 12 160 8	230,00 €	12,4
225	120 12 225 8	375,00 €	20,3
280	120 12 280 8	505,00 €	24,8
315	120 12 315 8	710,00 €	35,0

Metal Körüklü Kompansatörler / Hareketli Flanş (30 mm Laynerli)
 Metal Bellows Compensator / Moving Flange (30 mm With Liner)

Çap Dia	Kod Code	Fiyat (Adet) Price (Pcs)	Kg /Adet Kg/Pcs
40	120 13 040 8	93,00 €	
50	120 13 050 8	105,00 €	4,10
63	120 13 063 8	115,00 €	5,20
75	120 13 075 8	135,00 €	6,20
90	120 13 090 8	160,00 €	7,00
110	120 13 110 8	195,00 €	8,00
140	120 13 140 8	230,00 €	12,2
160	120 13 160 8	270,00 €	13,8
225	120 13 225 8	385,00 €	17,4
280	120 13 280 8	525,00 €	26,0

Kauçuk Kompansatörler
 Rubber Compensator

Çap Dia	Kod Code	Fiyat (Adet) Price (Pcs)	Kg /Adet Kg/Pcs
40	120 10 040 8	45,00 €	3,00
50	120 10 050 8	47,50 €	3,80
63	120 10 063 8	53,00 €	4,50
75	120 10 075 8	71,00 €	5,20
90	120 10 090 8	81,00 €	6,70
110	120 10 110 8	100,00 €	7,80
140	120 10 140 8	125,00 €	9,60
160	120 10 160 8	170,00 €	11,8
225	120 10 225 8	240,00 €	16,8
280	120 10 280 8	330,00 €	20,0
315	120 10 315 8	545,00 €	28,0
355	120 10 355 8	1,272,00 €	42,4
400	120 10 400 8	2,550,00 €	46,0

Kauçuk Kompansatörler / Rakor Bağlantılı
 Rubber Compensator With Union Connection

Çap Dia	Kod Code	Fiyat (Adet) Price (Pcs)	Kg /Adet Kg/Pcs
40	120 11 040 8	35,00 €	1,4
50	120 11 050 8	45,00 €	2
63	120 11 063 8	53,00 €	2,6
75	120 11 075 8	84,00 €	4
90	120 11 090 8	112,00 €	5,6

U-PVC

ÇEKVALF CHECKVALVE

ÜRETİM STANDARDI
 PRODUCTION STANDARD | EN 1452-3

ÇAP / SIZE Ø16 - Ø400



U-PVC Çıplak Çalparalı Çekvalf
U-PVC Wafer Check Valve

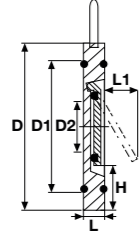

Su için / For Water

Asit için / For Acid

Çap Dia	Basınç PN	EPDM Conta Kod EPDM O-Ring Code	Fiyat (Adet) Price (Pcs)	FPM Conta Kod FPM O-Ring Code	Fiyat (Adet) Price (Pcs)	Kg /Adet Kg/Pcs	Koli/Ad. Box/Pcs	DN (mm)	D (mm)	D1 (mm)	D2 (mm)	L (mm)	L1 (mm)	H (mm)
63	10	221 01 063 9	20,75 €	221 02 063 9	28,20 €	0,19	5	50	90	75	32	16	40	18
75	10	221 01 075 9	25,75 €	221 02 075 9	34,70 €	0,26	5	65	110	95	40	16	55	20
90	10	221 01 090 9	28,75 €	221 02 090 9	38,60 €	0,34	5	80	125	115	54	16	67	23
110	10	221 01 110 9	33,85 €	221 02 110 9	45,30 €	0,48	5	100	184	135	70	19	67	35
125	10	221 01 125 9	38,80 €	221 02 125 9	51,70 €	0,55	5	100	213	160	92	21	94	37
140	10	221 01 140 9	44,40 €	221 02 140 9	60,30 €	0,64	5	125	213	160	92	21	94	37
160	10	221 01 160 9	50,00 €	221 02 160 9	68,20 €	0,95	5	150	251	175	105	23	100	47
200	10	221 01 200 9	62,00 €	221 02 200 9	85,15 €	1,32	5	200	280	235	155	27	152	41
225	10	221 01 225 9	71,00 €	221 02 225 9	92,30 €	1,57	5	200	280	235	155	27	152	41
250	10	221 01 250 9	135,00 €	221 02 250 9	195,00 €	2,57	5	250	330	285	330	40	180	41
280	10	221 01 280 9	203,00 €	221 02 280 9	248,00 €	2,58	5	250	330	285	330	40	180	41
315	10	221 01 315 9	275,00 €	221 02 315 9	377,00 €	3,87	5	300	380	325	380	45	215	41

U-PVC Flanş Bağlantılı Çalparalı Çekvalf (Takım-304 Paslanmaz Civata-Somun-Pul)
U-PVC Wafer Checkvalve With Flange (304 S.S. Screw, Nut, Washer)

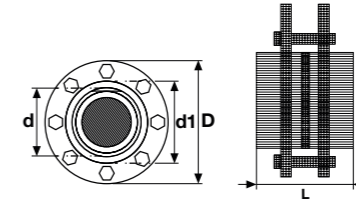

Su için / For Water

Asit için / For Acid

Çap Dia	Basınç PN	EPDM Conta Kod EPDM O-Ring Code	Fiyat (Adet) Price (Pcs)	FPM Conta Kod FPM O-Ring Code	Fiyat (Adet) Price (Pcs)	Kg /Adet Kg/Pcs	Koli/Ad. Box/Pcs	DN (mm)	D1 (mm)	D (mm)	L (mm)	nQe (mm)
63	10	221 04 063 2	53,20 €	221 05 063 2	63,84 €	3,10	1	50	77	165	90	4 x 16
75	10	221 04 075 2	58,80 €	221 05 075 2	70,56 €	3,40	1	65	90	185	110	4 x 16
90	10	221 04 090 2	67,20 €	221 05 090 2	80,64 €	3,71	1	80	107	200	126	8 x 16
110	10	221 04 110 2	81,20 €	221 05 110 2	97,44 €	4,56	1	100	129	220	155	8 x 16
125	10	221 04 125 2	88,20 €	221 05 125 2	105,84 €	5,55	1	100	147	250	173	8 x 16
140	10	221 04 140 2	102,20 €	221 05 140 2	122,64 €	5,77	1	125	164	250	182	8 x 16
160	10	221 04 160 2	116,20 €	221 05 160 2	139,44 €	7,47	1	150	188	285	209	8 x 20
200	10	221 04 200 2	173,60 €	221 05 200 2	208,32 €	10,0	1	200	230	340	253	8 x 20
225	10	221 04 225 2	201,60 €	221 05 225 2	241,92 €	10,1	1	200	245	340	285	8 x 20
250	10	221 04 250 2	425,60 €	221 05 250 2	510,72 €	20,6	1	250	269	395	375	12 x 20
280	10	221 04 280 2	529,20 €	221 05 280 2	635,04 €	20,5	1	250	304	395	375	12 x 20
315	10	221 04 315 2	742,40 €	221 05 315 2	892,08 €	25,1	1	300	341	445	415	12 x 20
400	10	221 04 400 2	2.520,00 €	221 05 400 2	3.024,00 €		1	400	450	565	482	16 x 24

U-PVC Flanş Bağlantılı Çalparalı Çekvalf
U-PVC Wafer Checkvalve With Flange

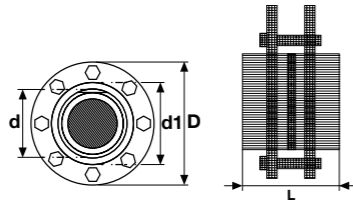

Su için / For Water

Asit için / For Acid

Çap Dia	Basınç PN	EPDM Conta Kod EPDM O-Ring Code	Fiyat (Adet) Price (Pcs)	FPM Conta Kod FPM O-Ring Code	Fiyat (Adet) Price (Pcs)	Kg /Adet Kg/Pcs	Koli/Ad. Box/Pcs	DN (mm)	D (mm)	D1 (mm)	L (mm)	nQe (mm)
63	10	221 00 063 2	38,00 €	221 08 063 2	49,40 €	1,83	1	50	165	77	90	4 x 16
75	10	221 00 075 2	42,00 €	221 08 075 2	54,60 €	2,31	1	65	185	90	110	4 x 16
90	10	221 00 090 2	48,00 €	221 08 090 2	62,40 €	3,75	1	80	200	107	126	8 x 16
110	10	221 00 110 2	58,00 €	221 08 110 2	75,40 €	4,35	1	100	220	129	155	8 x 16
125	10	221 00 125 2	63,00 €	221 08 125 2	81,90 €	5,35	1	100	250	147	173	8 x 16
140	10	221 00 140 2	73,00 €	221 08 140 2	95,00 €	5,87	1	125	250	164	182	8 x 16
160	10	221 00 160 2	83,00 €	221 08 160 2	108,00 €	7,03	1	150	285	188	209	8 x 20
200	10	221 00 200 2	124,00 €	221 08 200 2	161,00 €	10,0	1	200	340	230	253	8 x 20
225	10	221 00 225 2	144,00 €	221 08 225 2	187,00 €	10,5	1	200	340	245	285	8 x 20
250	10	221 00 250 2	304,00 €	221 08 250 2	395,00 €	16,2	1	250	395	269	375	12 x 20
280	10	221 00 280 2	378,00 €	221 08 280 2	491,00 €	15,5	1	250	395	304	375	12 x 20
315	10	221 00 315 2	531,00 €	221 08 315 2	690,00 €	19,8	1	300	445	341	415	12 x 20
400	10	221 00 400 2	1.800,00 €	221 08 400 2	2.340,00 €		1	400	565	450	482	16 x 24

U-PVC Flanş Bağlantılı Çalparalı Çekvalf (Takım-316 Paslanmaz Civata-Somun-Pul)
U-PVC Wafer Checkvalve With Flange (316 S.S. Screw, Nut, Washer)

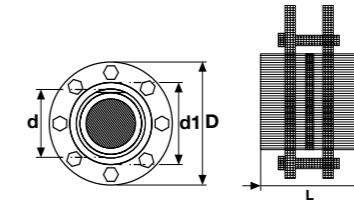

Su için / For Water

Asit için / For Acid

Çap Dia	Basınç PN	EPDM Conta Kod EPDM O-Ring Code	Fiyat (Adet) Price (Pcs)	FPM Conta Kod FPM O-Ring Code	Fiyat (Adet) Price (Pcs)	Kg /Adet Kg/Pcs	Koli/Ad. Box/Pcs	DN (mm)	D1 (mm)	D (mm)	L (mm)	nQe (mm)
63	10	221 06 063 2	74,48 €	221 07 063 2	89,38 €	3,10	1	50	77	165	90	4 x 16
75	10	221 06 075 2	82,32 €	221 07 075 2	98,78 €	3,40	1	65	90	185	110	4 x 16
90	10	221 06 090 2	94,08 €	221 07 090 2	112,90 €	3,71	1	80	107	200	126	8 x 16
110	10	221 06 110 2	113,68 €	221 07 110 2	136,42 €	4,56	1	100	129	220	155	8 x 16
125	10	221 06 125 2	123,48 €	221 07 125 2	148,18 €	5,55	1	100	147	250	173	8 x 16
140	10	221 06 140 2	143,08 €	221 07 140 2	171,70 €	5,77	1	125	164	250	182	8 x 16
160	10	221 06 160 2	162,68 €	221 07 160 2	195,22 €	7,47	1	150	188	285	209	8 x 20
200	10	221 06 200 2	243,04 €	221 07 200 2	291,65 €	10,0	1	200	230	340	253	8 x 20
225	10	221 06 225 2	282,24 €	221 07 225 2	338,69 €	10,1	1	200	245	340	285	8 x 20
250	10	221 06 250 2	595,84 €	221 07 250 2	715,00 €	20,6	1	250	269	395	375	12 x 20
280	10	221 06 280 2	740,88 €	221 07 280 2	889,06 €	20,5	1	250	304	395	375	12 x 20
315	10	221 06 315 2	1.040,76 €	221 07 315 2	1.248,91 €	25,1	1	300	341	445	415	12 x 20
400	10	221 06 400 2	3.528,00 €	221 07 400 2	4.233,60 €		1	400	450	565	482	16 x 24

U-PVC Yapıştırma Mufllu Yaylı Çekvalf

U-PVC Solvent Cement Spring Checkvalve

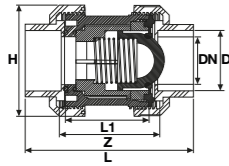

Çap Dia	Basınc PN	EPDM Conta Kod EPDM O-Ring Code	Fiyat (Adet) Price (Pcs)	Kg/Adet Kg/Pcs	Koli/Adet Box/Pcs	DN (mm)	H (mm)	L (mm)	L1 (mm)	Z (mm)
16	16	214 00 016 2	6,25 €	0,10	70	12	54	80	42	50
20	16	214 00 020 2	5,25 €	0,11	70	16	54	85	45	52
25	16	214 00 025 2	5,75 €	0,14	75	20	62	95	49	58
32	16	214 00 032 2	7,15 €	0,20	60	25	66	107	54	61
40	16	214 00 040 2	7,85 €	0,37	32	32	84	128	66	73
50	16	214 00 050 2	8,85 €	0,53	25	40	92	154	75	82
63	16	214 00 063 2	11,75 €	0,95	13	50	116	172	89	95
75	16	214 00 075 2	27,50 €	1,21	7	65	146	196	111	118
90	16	214 00 090 2	30,50 €	3,15	4	80	178	241	126	139
110	16	214 00 110 2	53,50 €	4,59	2	100	210	289	153	165

U-PVC Tek Taraf İçten Dişli Yaylı Çekvalf

U-PVC One Side Female Threaded Spring Checkvalve

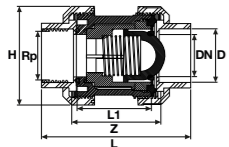

Çap Dia	Rp Inch	Basınc PN	EPDM Conta Kod EPDM O-Ring Code	Fiyat (Adet) Price (Pcs)	Kg/Adet Kg/Pcs	Koli/Adet Box/Pcs	DN (mm)	H (mm)	L (mm)	L1 (mm)	Z (mm)
16	3/8"	16	215 00 016 2	6,85 €	0,10	70	12	54	80	42	50
20	1/2"	16	215 00 020 2	5,85 €	0,11	70	16	54	85	45	52
25	3/4"	16	215 00 025 2	6,35 €	0,14	75	20	62	95	49	58
32	1"	16	215 00 032 2	7,85 €	0,20	60	25	66	107	54	61
40	1 1/4"	16	215 00 040 2	8,55 €	0,37	32	32	84	128	66	73
50	1 1/2"	16	215 00 050 2	9,75 €	0,53	25	40	92	154	75	82
63	2"	16	215 00 063 2	12,65 €	0,95	13	50	116	172	89	95
75	2 1/2"	16	215 00 075 2	29,05 €	1,21	7	65	146	196	111	118
90	3"	16	215 00 090 2	32,05 €	3,15	4	80	178	241	126	139
110	4"	16	215 00 110 2	55,00 €	4,59	2	100	210	289	153	165

U-PVC Çift Taraf İçten Dişli Yaylı Çekvalf

U-PVC Both Sides Female Threaded Spring Checkvalve

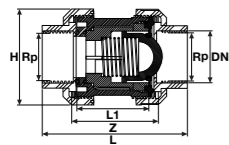

Rp Inch	Basınc PN	EPDM Conta Kod EPDM O-Ring Code	Fiyat (Adet) Price (Pcs)	Kg/Adet Kg/Pcs	Koli/Adet Box/Pcs	DN (mm)	H (mm)	L (mm)	L1 (mm)	Z (mm)
3/8"	16	216 00 016 2	7,45 €	0,10	70	12	54	80	42	50
1/2"	16	216 00 020 2	6,45 €	0,11	70	16	54	85	45	52
3/4"	16	216 00 025 2	6,95 €	0,14	75	20	62	95	49	58
1"	16	216 00 032 2	8,55 €	0,20	60	25	66	107	54	61
1 1/4"	16	216 00 040 2	9,25 €	0,37	32	32	84	128	66	73
1 1/2"	16	216 00 050 2	10,65 €	0,53	25	40	92	154	75	82
2"	16	216 00 063 2	13,55 €	0,95	13	50	116	172	89	95
2 1/2"	16	216 00 075 2	30,00 €	1,21	7	65	146	196	111	118
3"	16	216 00 090 2	33,00 €	3,15	4	80	178	241	126	139
4"	16	216 00 110 2	56,00 €	4,59	2	100	210	289	153	165

U-PVC Flanş Bağlantılı Yaylı Çekvalf

U-PVC Spring Checkvalve Both Sides With Flanges

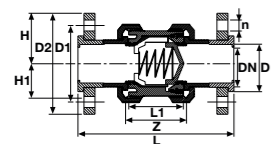

Çap Dia	Basınc PN	EPDM Conta Kod EPDM O-Ring Code	Fiyat (Adet) Price (Pcs)	Koli/Adet Box/Pcs	DN (mm)	Z (mm)	L1 (mm)	L (mm)	H (mm)	D1 (mm)	D2 (mm)	n (mm)
20	16	216 01 020 2	7,41 €	60	16	52	45	123	54	65	96	14x4
25	16	216 01 025 2	7,99 €	75	20	58	49	140	62	75	105	14x4
32	16	216 01 032 2	9,83 €	60	25	61	54	158	66	85	115	14x4
40	16	216 01 040 2	10,63 €	32	32	73	66	186	84	100	140	14x4
50	16	216 01 050 2	12,24 €	24	40	82	75	231	92	100	150	18x4
63	16	216 01 063 2	15,58 €	13	50	95	89	253	116	125	165	18x4
75	16	216 01 075 2	34,50 €	9	65	118	111	291	146	145	185	18x4
90	16	216 01 090 2	37,95 €	4	80	139	126	353	178	160	200	18x8
110	16	216 01 110 2	64,40 €	2	100	165	153	431	210	180	220	18x8

U-PVC Yapıştırma Mufllu Toplu Çekvalf

U-PVC Solvent Cement Ball Checkvalve

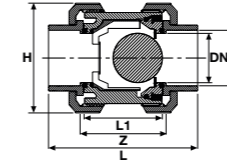

Çap Dia	Basınc PN	EPDM Conta Kod EPDM O-Ring Code	Fiyat (Adet) Price (Pcs)	Kg/Adet Kg/Pcs	Koli/Adet Box/Pcs	DN (mm)	H (mm)	L (mm)	L1 (mm)	Z (mm)
20	16	217 00 020 2	9,01 €	0,10	70	16	54	85	45	52
25	16	217 00 025 2	11,88 €	0,10	85	20	62	95	49	58
32	16	217 00 032 2	15,45 €	0,15	72	25	66	107	54	61
40	16	217 00 040 2	25,33 €	0,54	32	32	84	128	66	73
50	16	217 00 050 2	35,19 €	0,54	24	40	92	154	75	82
63	16	217 00 063 2	51,92 €	0,54	13	50	116	172	89	95
75	16	217 00 075 2	178,87 €			65	146	196	111	118
90	16	217 00 090 2	197,84 €			80	178	241	126	139
110	16	217 00 110 2	257,02 €			100	210	289	153	165

U-PVC Tek Taraf İçten Dişli Toplu Çekvalf

U-PVC One Side Female Threaded Ball Checkvalve

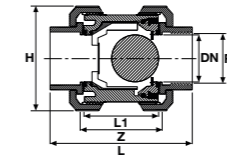

Çap Dia	Rp Inch	Basınc PN	EPDM Conta Kod EPDM O-Ring Code	Fiyat (Adet) Price (Pcs)	Kg/Adet Kg/Pcs	Koli/Adet Box/Pcs	DN (mm)	H (mm)	L (mm)	L1 (mm)	Z (mm)
16	3/8"	16	217 01 016 2	0	0,12	70	12	54	80	42	50
20	1/2"	16	217 01 020 2	11,71 €	0,10	70	16	54	85	45	52
25	3/4"	16	217 01 025 2	15,44 €	0,15	85	20	62	95	49	58
32	1"	16	217 01 032 2	20,09 €	0,19	72	25	66	107	54	61
40	1 1/4"	16	217 01 040 2	32,93 €	0,35	32	32	84	128	66	73
50	1 1/2"	16	217 01 050 2	45,75 €	0,54	24	40	92	154	75	82
63	2"	16	217 01 063 2	67,50 €	0,91	13	50	116	172	89	95

U-PVC Çift Taraf İçten Dişli Toplu Çekvalf

U-PVC Both Sides Female Threaded Ball Checkvalve

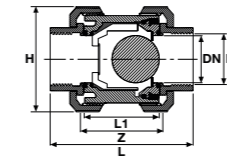

Rp Inch	Basınc PN	EPDM Conta Kod EPDM O-Ring Code	Fiyat (Adet) Price (Pcs)	Kg/Adet Kg/Pcs	Koli/Adet Box/Pcs	DN (mm)	H (mm)	L (mm)	L1 (mm)	Z (mm)
3/8"	16	217 02 016 2	0	0,12	70	12	54	80	42	50
1/2"	16	217 02 020 2	13,06 €	0,10	70	16	54	85	45	52
3/4"	16	217 02 025 2	17,23 €	0,15	85	20	62	95	49	58
1"	16	217 02 032 2	22,40 €	0,19	72	25	66	107	54	61
1 1/4"	16	217 02 040 2	36,73 €	0,35	32	32	84	128	66	73
1 1/2"	16	217 02 050 2	51,03 €	0,54	24	40	92	154	75	82
2"	16	217 02 063 2	75,28 €	0,91	13	50	116	172	89	95

U-PVC Yapıştırma Mufllu Tek Taraflı Yaylı Çekvalf
U-PVC Single Union Spring Checkvalve

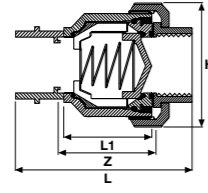

Çap Dia	Basınç PN	EPDM Conta Kod EPDM O-Ring Code	Fiyat (Adet) Price (Pcs)	Kg/Adet Kg/Pcs	Koli/Adet Box/Pcs	DN (mm)	H (mm)	L (mm)	L1 (mm)	Z (mm)
20	16	214 10 020 2	4,42 €	0,09	60	16	47	47	45	55
25	16	214 10 025 2	4,68 €	0,16	75	20	52	52	49	59
32	16	214 10 032 2	5,53 €	0,20	60	25	63	63	54	69
40	16	214 10 040 2	5,95 €	0,45	32	32	66	66	66	72
50	16	214 10 050 2	6,97 €	0,54	20	40	89	89	75	91
63	16	214 10 063 2	9,18 €	0,95	13	50	100	100	89	103
75	16	214 10 075 2	25,50 €		9	65	146	128	111	111
90	16	214 10 090 2	29,05 €		4	80	178	227	125	141
110	16	214 10 110 2	50,10 €		2	100	210	275	155	171

U-PVC Tek Taraf Dış Dişli Tek Taraflı Yaylı Çekvalf
U-PVC One Side Male Threaded Single Union Spring Checkvalve

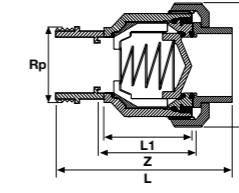

Çap Dia	Rp Inch	Basınç PN	EPDM Conta Kod EPDM O-Ring Code	Fiyat (Adet) Price (Pcs)	Kg/Adet Kg/Pcs	Koli/Adet Box/Pcs	DN (mm)	H (mm)	L (mm)	L1 (mm)	Z (mm)
20	1/2"	16	215 20 020 2	5,30 €	0,09	60	16	47	78	45	55
25	3/4"	16	215 20 025 2	5,65 €	0,16	75	20	52	87	49	59
32	1"	16	215 20 032 2	6,78 €	0,20	60	25	63	100	54	69
40	1 1/4"	16	215 20 040 2	7,22 €	0,45	32	32	66	114	66	72
50	1 1/2"	16	215 20 050 2	8,26 €	0,54	20	40	89	140	75	91
63	2"	16	215 20 063 2	10,52 €	0,95	13	50	100	163	89	103
75	2 1/2"	16	215 20 075 2	27,00 €		9	65	146	196	111	111
90	3"	16	215 20 090 2	31,50 €		4	80	178	227	125	141
110	4"	16	215 20 110 2	52,10 €		2	100	210	275	155	171

U-PVC Tek Taraf İç Dişli Tek Taraflı Yaylı Çekvalf
U-PVC One Side Female Threaded Single Union Spring Checkvalve

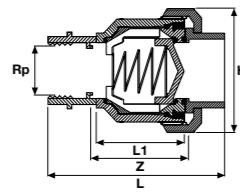

Çap Dia	Rp Inch	Basınç PN	EPDM Conta Kod EPDM O-Ring Code	Fiyat (Adet) Price (Pcs)	Kg/Adet Kg/Pcs	Koli/Adet Box/Pcs	DN (mm)	H (mm)	L (mm)	L1 (mm)	Z (mm)
20	1/2"	16	215 10 020 2	5,30 €	0,09	60	16	47	47	45	55
25	3/4"	16	215 10 025 2	5,65 €	0,16	75	20	52	52	49	59
32	1"	16	215 10 032 2	6,78 €	0,20	60	25	63	63	54	69
40	1 1/4"	16	215 10 040 2	7,22 €	0,45	32	32	66	66	66	72
50	1 1/2"	16	215 10 050 2	8,26 €	0,54	20	40	89	89	75	91
63	2"	16	215 10 063 2	10,52 €	0,95	13	50	100	100	89	103
75	2 1/2"	16	215 10 075 2	27,00 €		9	65	146	128	111	111
90	3"	16	215 10 090 2	31,50 €		4	80	178	227	125	141
110	4"	16	215 10 110 2	52,10 €		2	100	210	275	155	171

U-PVC Tek Taraf Dış Dişli Tek Taraf İç Dişli Yaylı Çekvalf
U-PVC One Side Male Threaded One Side Female Threaded Single Union Spring Checkvalve

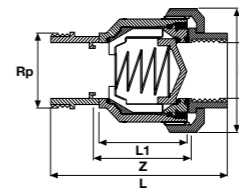

Çap Dia	Rp Inch	Basınç PN	EPDM Conta Kod EPDM O-Ring Code	Fiyat (Adet) Price (Pcs)	Kg/Adet Kg/Pcs	Koli/Adet Box/Pcs	DN (mm)	H (mm)	L (mm)	L1 (mm)	Z (mm)
20	1/2"	16	216 20 020 2	6,09 €	0,09	60	16	47	78	45	55
25	3/4"	16	216 20 025 2	6,43 €	0,16	75	20	52	87	49	59
32	1"	16	216 20 032 2	7,74 €	0,20	60	25	63	100	54	69
40	1 1/4"	16	216 20 040 2	8,17 €	0,45	32	32	66	114	66	72
50	1 1/2"	16	216 20 050 2	9,39 €	0,54	20	40	89	140	75	91
63	2"	16	216 20 063 2	11,65 €	0,95	13	50	100	163	89	103
75	2 1/2"	16	216 20 075 2	27,00 €		9	65	146	196	111	111
90	3"	16	216 20 090 2	31,50 €		4	80	178	227	125	141
110	4"	16	216 20 110 2	52,10 €		2	100	210	275	155	171

U-PVC Çift Taraf İç Dişli Tek Taraflı Yaylı Çekvalf
U-PVC Both Sides Female Threaded Single Union Spring Checkvalve

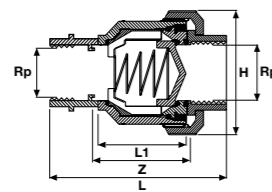

Rp Inch	Basınç PN	EPDM Conta Kod EPDM O-Ring Code	Fiyat (Adet) Price (Pcs)	Kg/Adet Kg/Pcs	Koli/Adet Box/Pcs	DN (mm)	H (mm)	L (mm)	L1 (mm)	Z (mm)
1/2"	16	216 10 020 2	6,09 €	0,09	60	16	47	78	45	55
3/4"	16	216 10 025 2	6,43 €	0,16	75	20	52	87	49	59
1"	16	216 10 032 2	7,74 €	0,20	60	25	63	100	54	69
1 1/4"	16	216 10 040 2	8,17 €	0,45	32	32	66	114	66	72
1 1/2"	16	216 10 050 2	9,39 €	0,54	20	40	89	140	75	91
2"	16	216 10 063 2	11,65 €	0,95	13	50	100	163	89	103
2 1/2"	16	216 10 075 2	27,00 €		9	65	146	196	111	111
3"	16	216 10 090 2	31,50 €		4	80	178	227	125	141
4"	16	216 10 110 2	52,10 €		2	100	210	275	155	171

U-PVC Y Çekvalf
U-PVC Angle Seat Valve

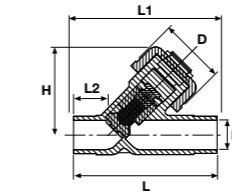

Çap Dia	Basınç PN	EPDM Conta Kod EPDM O-Ring Code	Fiyat (Adet) Price (Pcs)	Kg/Adet Kg/Pcs	Koli/Adet Box/Pcs	DN (mm)	D (mm)	L (mm)	L1 (mm)	L2 (mm)	H (mm)
20	16	222 00 020 4	51,00 €	0,13	1	15	43	124	130	28	65
25	16	222 00 025 4	60,00 €	0,20	1	20	47	144	150	37	75
32	16	222 00 032 4	72,00 €	0,32	1	25	56	154	160	37	90
40	16	222 00 040 4	89,00 €	0,49	1	32	64	174	180	44	102
50	16	222 00 050 4	129,00 €	0,86	1	40	82	194	200	48	123
63	16	222 00 063 4	187,00 €	1,45	1	50	95	224	230	60	144
75	16	222 00 075 4	321,00 €	2,49	1	65	92	284	290	74	186
90	16	222 00 090 4	417,00 €	3,51	1	80	104	300	310	85	204

U-PVC Yapıştırma Muflu T Çekvalf
U-PVC T Checkvalve

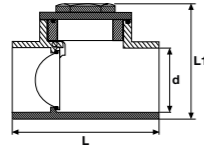

Su İçin / For Water

Asit İçin / For Acid

Çap Dia	Basınç PN	FPM Conta Kod FPM O-Ring Code	Fiyat (Adet) Price (Pcs)	FPM Conta Kod FPM O-Ring Code	Fiyat (Adet) Price (Pcs)	Kg/Adet Kg/Pcs	Koli/Adet Box/Pcs	DN (mm)	L (mm)	L1 (mm)
50	10	218 00 050 2	5,50 €	218 01 050 2	7,15 €	0,30	40	40	124	96
63	10	218 00 063 2	7,00 €	218 01 063 2	9,10 €	0,46	22	50	144	112
75	10	218 00 075 2	17,00 €	218 01 075 2	22,10 €		10	65	168	140
90	10	218 00 090 2	25,93 €	218 01 090 2	33,70 €		10	80	195	161

U-PVC Tek Taraf İç Dişli T Çekvalf
U-PVC One Side Female Threaded T Check Valve

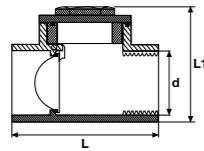

Su İçin / For Water

Asit İçin / For Acid

Çap Dia	DN (mm)	Basınç PN	FPM Conta Kod FPM O-Ring Code	Fiyat (Adet) Price (Pcs)	FPM Conta Kod FPM O-Ring Code	Fiyat (Adet) Price (Pcs)	Kg/Adet Kg/Pcs	Koli/Adet Box/Pcs	L (mm)	L1 (mm)
50	1 1/2"	10	219 00 050 2	6,50 €	219 01 050 2	8,45 €	0,32	40	124	96
63	2"	10	219 00 063 2	8,00 €	219 01 063 2	10,40 €	0,49	22	144	112
75	2 1/2"	10	219 00 075 2	18,50 €	219 01 075 2	24,05 €			168	140
90	3"	10	219 00 090 2	27,25 €	219 01 090 2	35,50 €			195	161

U-PVC Çift Taraf İç Dişli T Çekvalf
U-PVC Both Side Female Threaded T Check Valve

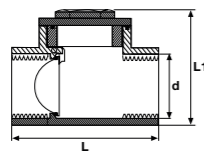

Su İçin / For Water

Asit İçin / For Acid

Rp Inch	Basınç PN	FPM Conta Kod FPM O-Ring Code	Fiyat (Adet) Price (Pcs)	FPM Conta Kod FPM O-Ring Code	Fiyat (Adet) Price (Pcs)	Kg/Adet Kg/Pcs	Koli/Adet Box/Pcs	L (mm)	L1 (mm)
1 1/2"	10	219 10 050 2	7,50 €	219 11 050 2	9,75 €	0,30	40	124	96
2"	10	219 10 063 2	9,00 €	219 11 063 2	11,70 €	0,46	22	144	112
2 1/2"	10	219 10 075 2	19,50 €	219 11 075 2	25,35 €			168	140
3"	10	219 10 090 2	28,05 €	219 11 090 2	37,00 €			195	161

U-PVC Tek Taraf Rakorlu Kuyu Çekvalfi
U-PVC Single Union Foot Checkvalve

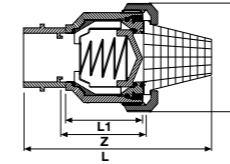

Çap Dia	Basınç PN	EPDM Conta Kod EPDM O-Ring Code	Fiyat (Adet) Price (Pcs)	Kg/Adet Kg/Pcs	Koli/Adet Box/Pcs	DN (mm)	H (mm)	L (mm)	L1 (mm)	Z (mm)
20	16	214 30 020 2	5,25 €		60	16	47	108	45	55
25	16	214 30 025 2	5,75 €		75	20	52	115	49	59
32	16	214 30 032 2	7,15 €		60	25	63	140	54	69
40	16	214 30 040 2	7,85 €		32	32	66	160	66	72
50	16	214 30 050 2	8,85 €		24	40	89	180	75	91
63	16	214 30 063 2	11,75 €		13	50	100	220	89	103
75	16	214 30 075 2	27,50 €		9	65	146	270	111	111
90	16	214 30 090 2	30,50 €		4	80	178	335	125	141
110	16	214 30 110 2	53,50 €		2	100	210	345	155	171

U-PVC Tek Taraf Rakorlu İç Dişli Kuyu Çekvalfi
U-PVC Single Union Female Threaded Foot Checkvalve

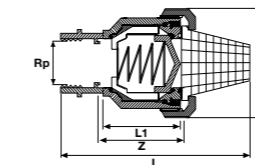

Rp Inch	Basınç PN	EPDM Conta Kod EPDM O-Ring Code	Fiyat (Adet) Price (Pcs)	Kg/Adet Kg/Pcs	Koli/Adet Box/Pcs	DN (mm)	H (mm)	L (mm)	L1 (mm)	Z (mm)
1/2"	16	215 30 020 2	5,85 €		60	16	47	108	45	55
3/4"	16	215 30 025 2	6,35 €		75	20	52	115	49	59
1"	16	215 300 32 2	7,85 €		60	25	63	140	54	69
1 1/4"	16	215 300 40 2	8,55 €		32	32	66	160	66	72
1 1/2"	16	215 300 50 2	9,75 €		24	40	89	180	75	91
2"	16	215 300 63 2	12,65 €		13	50	100	220	89	103
2 1/2"	16	215 300 75 2	29,05 €		9	65	146	270	111	111
3"	16	215 300 90 2	32,05 €		4	80	178	335	125	141
4"	16	215 30 110 2	55,00 €		2	100	210	345	155	171

U-PVC Yapıştırma Muflu Kuyu Çekvalfi
U-PVC Foot Spring Checkvalve

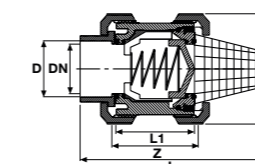

Çap Dia	Basınç PN	EPDM Conta Kod EPDM O-Ring Code	Fiyat (Adet) Price (Pcs)	Kg/Adet Kg/Pcs	Koli/Adet Box/Pcs	DN (mm)	H (mm)	L (mm)	L1 (mm)	Z (mm)
20	16	217 03 020 2	4,42 €		55	16	54	108	48	55
25	16	217 03 025 2	4,68 €		60	20	62	115	52	60
32	16	217 03 032 2	5,53 €		60	25	66	140	56	64
40	16	217 03 040 2	5,95 €		32	32	84	160	70	77
50	16	217 03 050 2	6,97 €		24	40	92	180	77	84
63	16	217 03 063 2	9,18 €		13	50	116	220	90	98
75	16	217 03 075 2	25,50 €		9	65	146	270	102	111
90	16	217 03 090 2	29,05 €		4	80	178	335	128	141
110	16	217 03 110 2	50,10 €		2	100	210	345	159	171

U-PVC İçten Dişli Kuyu Çekvalfi
U-PVC Female Threaded Spring Foot Checkvalve

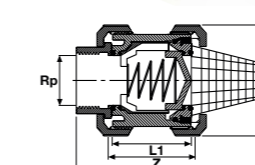

Rp Inch	Basınç PN	EPDM Conta Kod EPDM O-Ring Code	Fiyat (Adet) Price (Pcs)	Kg/Adet Kg/Pcs	Koli/Adet Box/Pcs	DN (mm)	H (mm)	L (mm)	L1 (mm)	Z (mm)
1/2"	16	217 04 020 2	5,30 €		60	16	54	108	48	55
3/4"	16	217 04 025 2	5,65 €		75	20	62	115	52	60
1"	16	217 04 032 2	6,78 €		60	25	66	140	56	64
1 1/4"	16	217 04 040 2	7,22 €		32	32	84	160	70	77
1 1/2"	16	217 04 050 2	8,26 €		24	40	92	180	77	84
2"	16	217 04 063 2	10,52 €		13	50	116	220	90	98
2 1/2"	16	217 04 075 2	27,00 €		9	65	146	270	102	111
3"	16	217 04 090 2	31,50 €		4	80	178	335	128	141
4"	16	217 04 110 2	52,10 €		2	100	210	345	159	171

U-PVC Atık Su Çekvalfi
Anti-Flooding Valve

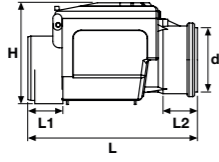

Çap Dia	Basınç PN	Kod Code	Fiyat (Adet) Price (Pcs)	Kg/Adet Kg/Pcs	Koli/Adet Box/Pcs	H (mm)	L (mm)	L1 (mm)	L2 (mm)
110	10	533 00 100 2	25,00 €	2,720	1	255	366	59	56
125	10	533 00 125 2	30,00 €	2,780	1	255	388	69	69
160	10	533 00 150 2	35,00 €	2,880	1	255	442	96	93

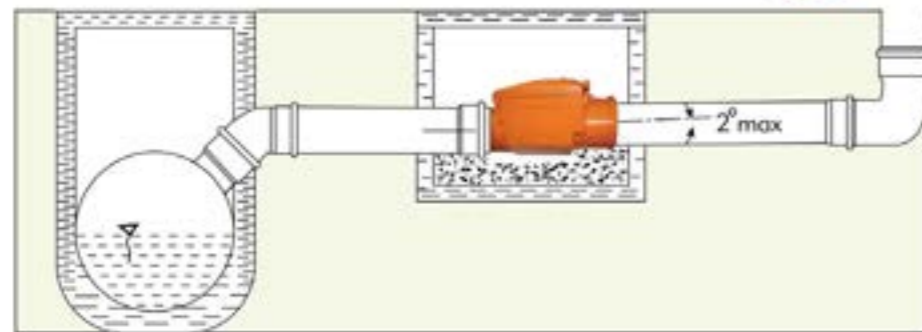
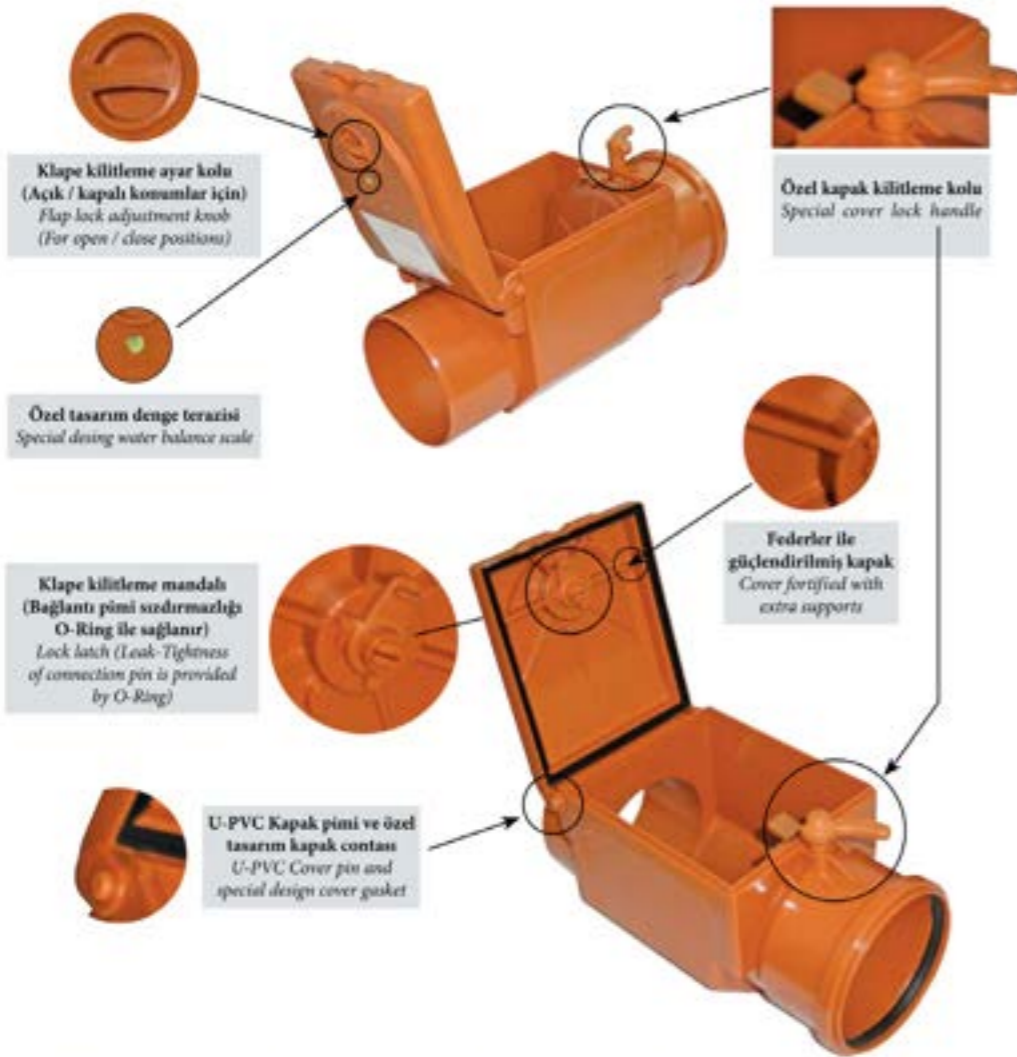

U-PVC

KELEBEK VANA

BUTTERFLY VALVES

ÜRETİM STANDARTI
PRODUCTION STANDARD | TS EN ISO 16136

ÇAP / SIZE Ø63 - Ø400



U-PVC Kelebek Vana (Çıplak)
U-PVC Butterfly Valve (Without Flange)

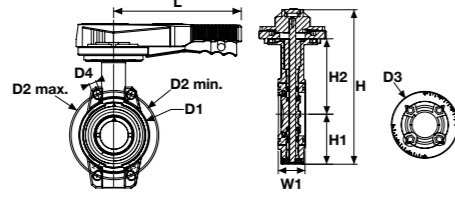

Su İçin / For Water

Asit İçin / For Acid

Çap Dia	Basınç PN	EPDM Conta Kod EPDM O-Ring Code	Fiyat (Adet) Price (Pcs)	FPM Conta Kod FPM O-Ring Code	Fiyat (Adet) Price (Pcs)	Kg /Adet Kg/Pcs	Koli/Ad. Box/Pcs
63	10	201 00 063 4	41,00 €	201 01 063 4	61,50 €	1,18	1
75	10	201 00 075 4	45,00 €	201 01 075 4	67,50 €	1,26	1
90	10	201 00 090 4	48,00 €	201 01 090 4	72,00 €	1,42	1
110	10	201 00 110 4	55,00 €	201 01 110 4	82,50 €	2,23	1
125	10	201 00 125 4	62,00 €	201 01 125 4	93,00 €	2,77	1
140	10	201 00 140 4	62,00 €	201 01 140 4	93,00 €	2,77	1
160	10	201 00 160 4	79,00 €	201 01 160 4	118,50 €	3,22	1
200	10	201 00 200 4	132,00 €	201 01 200 4	198,00 €	5,12	1
225	10	201 00 225 4	132,00 €	201 01 225 4	198,00 €	5,12	1
250	10	201 00 250 4	350,00 €	201 01 250 4	525,00 €	9,14	1
280	10	201 00 280 4	350,00 €	201 01 280 4	525,00 €	9,14	1
315	10	201 00 315 4	900,00 €	201 01 315 4	1.350,00 €	24,3	1
*355	6	201 00 355 4	3.268,87 €	201 01 355 4	①		1
*400	6	201 00 400 4	3.268,87 €	201 01 400 4	①		1

Çap Dia	DN	D1 (mm)	D2 min. (mm)	D2 max. (mm)	D3 (mm)	D4 (mm)	L (mm)	H (mm)	H1 (mm)	H2 (mm)	W1 (mm)	nØe	kv-value l/min.	ISO 5211 ISO 5211
63	50	104	120	125	115	19	207	256	82	126	45	4 x 19	1470	F 07
75	65	115	140	145	115	19	207	265	86	129	46	4 x 19	2200	F 07
90	80	131	150	160	115	19	207	272	89	132	48	8 x 19	3000	F 07
110	100	160	175	190	115	19	207	311	103	156	56	8 x 19	6500	F 07
125	110	190	210	216	115	23	258	338	116	169	63	8 x 23	11500	F 07
140	125	190	210	216	115	23	258	338	116	169	63	8 x 23	11500	F 07
160	150	214	241	241	115	24	258	364	129	182	66	8 x 24	16600	F 07
200	175	268	290	295	115	24	335	414	158	203	75	8 x 24	39600	F 07
225	200	268	290	295	115	24	335	414	158	203	75	8 x 24	39600	F 07
250	250	333	353	362	156	24	410	507	198	242	114	8 x 24	55200	F 10
280	250	333	353	362	156	24	410	507	198	242	114	12 x 24	55200	F 10
315	300	379	400	432	156	24	410	580	228	285	113	12 x 24	80000	F 10
*355	350	535	445	477	156	26	410	620	268	305	140	16 x 24	90000	F 12
*400	400	595	510	540	156	26	410	686	285	335	168	16 x 26	115000	F 12

* Redüktör Dişli Kelebek Vana / Reduction Gear Butterfly Valve

U-PVC Flanşlı Kelebek Vana (Takım)
U-PVC Butterfly Valve With Flange Adaptor

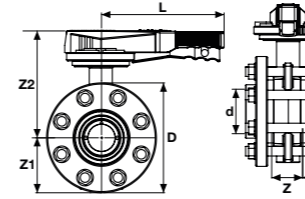

Su İçin / For Water

Asit İçin / For Acid

Çap Dia	Basınç PN	EPDM Conta Kod EPDM O-Ring Code	Fiyat (Adet) Price (Pcs)	FPM Conta Kod FPM O-Ring Code	Fiyat (Adet) Price (Pcs)	Kg /Adet Kg/Pcs	Koli/Ad. Box/Pcs
63	10	200 00 063 2	60,00 €	200 01 063 4	90,00 €	3,00	1
75	10	200 00 075 2	65,00 €	200 01 075 4	97,50 €	5,00	1
90	10	200 00 090 2	72,00 €	200 01 090 4	108,00 €	6,60	1
110	10	200 00 110 2	81,00 €	200 01 110 4	121,50 €	6,60	1
125	10	200 00 125 2	95,00 €	200 01 125 4	142,50 €	9,50	1
140	10	200 00 140 2	95,00 €	200 01 140 4	142,50 €	9,90	1
160	10	200 00 160 2	139,00 €	200 01 160 4	208,50 €	11,4	1
200	10	200 00 200 2	195,00 €	200 01 200 4	292,50 €	17,1	1
225	10	200 00 225 2	199,00 €	200 01 225 4	298,50 €	36,7	1
250	10	200 00 250 2	505,00 €	200 01 250 4	757,00 €	36,7	1
280	10	200 00 280 2	520,00 €	200 01 280 4	780,00 €	39,2	1
315	10	200 00 315 2	1.200,00 €	200 01 315 4	1.725,00 €	44,5	1
*355	6	200 00 355 2	4.485,00 €	200 01 355 4	①		1
*400	6	200 00 400 2	4.485,00 €	200 01 400 4	①		1

304 Paslanmaz Civata-Somun-Pul / 304.S.S.Screw,Nut,Washer

Su İçin / For Water

Asit İçin / For Acid

Çap Dia	EPDM Conta Kod EPDM O-Ring Code	Fiyat (Adet) Price (Pcs)	FPM Conta Kod FPM O-Ring Code	Fiyat (Adet) Price (Pcs)
63	200 02 063 4	84,00 €	200 03 063 4	109,20 €
75	200 02 075 4	91,00 €	200 03 075 4	118,30 €
90	200 02 090 4	100,80 €	200 03 090 4	131,04 €
110	200 02 110 4	119,00 €	200 03 110 4	154,70 €
125	200 02 125 4	133,00 €	200 03 125 4	172,90 €
140	200 02 140 4	133,00 €	200 03 140 4	172,90 €
160	200 02 160 4	194,60 €	200 03 160 4	252,98 €
200	200 02 200 4	273,00 €	200 03 200 4	354,90 €
225	200 02 225 4	278,60 €	200 03 225 4	362,18 €
250	200 02 250 4	707,00 €	200 03 250 4	919,10 €
280	200 02 280 4	728,00 €	200 03 280 4	964,60 €
315	200 02 315 4	1.610,00 €	200 03 315 4	2.093,00 €
355	200 02 355 4	5.520,00 €	200 03 355 4	①
400	200 02 400 4	5.520,00 €	200 03 400 4	①

316 Paslanmaz Civata-Somun-Pul / 316.S.S.Screw,Nut,Washer

Su İçin / For Water

Asit İçin / For Acid

Çap Dia	EPDM Conta Kod EPDM O-Ring Code	Fiyat (Adet) Price (Pcs)	FPM Conta Kod FPM O-Ring Code	Fiyat (Adet) Price (Pcs)
63	200 04 063 4	126,00 €	200 05 063 4	176,40 €
75	200 04 075 4	136,50 €	200 05 075 4	191,10 €
90	200 04 090 4	151,20 €	200 05 090 4	211,68 €
110	200 04 110 4	178,50 €	200 05 110 4	249,90 €
125	200 04 125 4	199,50 €	200 05 125 4	279,30 €
140	200 04 140 4	199,50 €	200 05 140 4	279,30 €
160	200 04 160 4	291,90 €	200 05 160 4	408,66 €
200	200 04 200 4	409,50 €	200 05 200 4	573,30 €
225	200 04 225 4	417,90 €	200 05 225 4	585,06 €
250	200 04 250 4	1.060,50 €	200 05 250 4	1.484,70 €
280	200 04 280 4	1.092,50 €	200 05 280 4	1.528,80 €
315	200 04 315 4	2.415,00 €	200 05 315 4	3.381,00 €
355	200 04 355 4	6.555,00 €	200 05 355 4	①
400	200 04 400 4	6.555,00 €	200 05 400 4	①

Çap Dia	DN	D (mm)	Z (mm)	Z1 (mm)	Z2 (mm)	B (mm)	L (mm)	Q1 (mm)	Q2 (mm)	nØe	ISO 5211 ISO 5211	kv-value l/min.	Basınç PN	Kg /Adet Kg/Pcs	Koli/Ad. Box/Pcs
63	50	165	51	82	188	38	207	37		4 x 19	F 07	1470	10	3,00	1
75	65	185	52	92	180	43	207	50	40	4 x 19	F 07	2200	10	5,00	1
90	80	200	58	100	183	51	207	65	46	8 x 19	F 07	3000	10	6,60	1
110	100	220	66	110	208	60	258	85	68	8 x 19	F 07	6500	10	6,60	1
125	110	250	73	125	221	69	258	111	92	8 x 23	F 07	11500	10	9,50	1
140	125	250	73	125	221	75	258	111	92	8 x 23	F 07	11500	10	9,90	1
160	150	285	76	142	235	86	258	138	122	8 x 24	F 07	16600	10	11,4	1
200	175	340	87	170	255	106	335	192	179	8 x 24	F 07	39600	10	17,1	1
225	200	340	87	170	255	120	335	192	179	8 x 24	F 07	39600	10	36,7	1
250	250	395	123	198	309	131	410	223	209	8 x 24	F 10	55200	10	36,7	1
280	250	395	119	198	309	146	410	223	209	12 x 24	F 10	55200	10	39,2	1
315	300	445	121	228	370	164	410	256	253	12 x 24	F 10	80000	10	44,5	1
*355	350	505	140	255	372	185	410	325	305	16 x 24	F 12	90000	6		1
*400	400	565	169	285	402	206	410	353	350	16 x 26	F 12	115000	6		1

* Redüktör Dişli Kelebek Vana / Reduction Gear Butterfly Valve

U-PVC Redüktör Dişli Kelebek Vana (Çıplak)
U-PVC Reduction Gear Butterfly Valve With Handwheel (Without Flange)

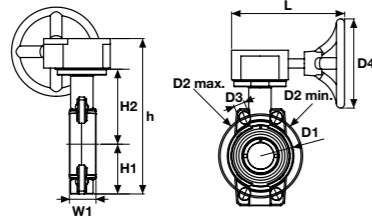

Su İçin / For Water

Asit İçin / For Acid

Çap Dia	Basınç PN	EPDM Conta Kod EPDM O-Ring Code	Fiyat (Adet) Price (Pcs)	FPM Conta Kod FPM O-Ring Code	Fiyat (Adet) Price (Pcs)	Kg /Adet Kg/Pcs	Koli/Ad. Box/Pcs
63	10	201 11 063 4	91,60 €	201 02 063 4	112,10 €		1
75	10	201 11 075 4	95,60 €	201 02 075 4	118,10 €		1
90	10	201 11 090 4	98,60 €	201 02 090 4	122,60 €		1
110	10	201 11 110 4	105,60 €	201 02 110 4	133,10 €		1
125	10	201 11 125 4	172,00 €	201 02 125 4	203,00 €		1
140	10	201 11 140 4	172,00 €	201 02 140 4	203,00 €		1
160	10	201 11 160 4	189,00 €	201 02 160 4	228,50 €		1
200	10	201 11 200 4	242,00 €	201 02 200 4	308,00 €		1
225	10	201 11 225 4	242,00 €	201 02 225 4	308,00 €		1
250	10	201 11 250 4	460,00 €	201 02 250 4	635,00 €		1
280	10	201 11 280 4	460,00 €	201 02 280 4	635,00 €		1
315	10	201 11 315 4	1.010,00 €	201 02 315 4	1.460,00 €		1
355	6	201 11 355 4	3.268,87 €	201 02 355 4	①		1
400	6	201 11 400 4	3.268,87 €	201 02 400 4	①		1

Çap Dia	DN	D1 (mm)	D2 min. (mm)	D2 max. (mm)	D3 (mm)	D4 (mm)	L (mm)	H (mm)	H1 (mm)	H2 (mm)	W1 (mm)	nØe	kv-value l/min.	ISO 5211 ISO 5211
63	50	104	120	125	115	19	192	279	82	126	45	4 x 19	1470	F 07
75	65	115	140	145	115	19	192	288	86	129	46	4 x 19	2200	F 07
90	80	131	150	160	115	19	192	290	89	132	48	8 x 19	3000	F 07
110	100	160	175	190	115	19	192	337	103	156	56	8 x 19	6500	F 07
125	110	190	210	216	115	23	192	353	116	169	63	8 x 23	11500	F 07
140	125	190	210	216	115	23	192	353	116	169	63	8 x 23	11500	F 07
160	150	214	241	241	115	24	192	375	129	182	66	8 x 24	16600	F 07
200	175	268	290	295	115	24	192	429	158	203	75	8 x 24	39600	F 07
225	200	268	290	295	115	24	192	429	158	203	75	8 x 24	39600	F 07
250	250	333	353	362	156	24	250	485	198	242	114	8 x 24	55200	F 10
280	250	333	353	362	156	24	250	485	198	242	114	12 x 24	55200	F 10
315	300	379	400	432	156	24	250	581	228	285	113	12 x 24	80000	F 10
355	350	535	445	477	156	26	250	581	268	305	140	16 x 24	90000	F 12
400	400	595	510	540	156	26	250	581	285	335	168	16 x 26	115000	F 12

U-PVC Redüktör Dişli Flanşlı Kelebek Vana (Takım)
U-PVC Reduction Gear Butterfly Valve With Handwheel and Flange

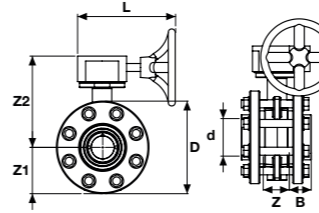

Su İçin / For Water

Asit İçin / For Acid

Çap Dia	Basınç PN	EPDM Conta Kod EPDM O-Ring Code	Fiyat (Adet) Price (Pcs)	FPM Conta Kod FPM O-Ring Code	Fiyat (Adet) Price (Pcs)	Kg /Adet Kg/Pcs	Koli/Ad. Box/Pcs
63	10	201 03 063 4	110,60 €	201 09 063 4	140,60 €	3,00	1
75	10	201 03 075 4	115,60 €	201 09 075 4	148,10 €	3,60	1
90	10	201 03 090 4	122,60 €	201 09 090 4	158,60 €	5,45	1
110	10	201 03 110 4	131,60 €	201 09 110 4	172,10 €	6,60	1
125	10	201 03 125 4	205,00 €	201 09 125 4	252,50 €	9,50	1
140	10	201 03 140 4	205,00 €	201 09 140 4	252,50 €	9,90	1
160	10	201 03 160 4	249,00 €	201 09 160 4	318,50 €	11,4	1
200	10	201 03 200 4	305,00 €	201 09 200 4	402,50 €	17,1	1
225	10	201 03 225 4	309,00 €	201 09 225 4	408,50 €	17,1	1
250	10	201 03 250 4	615,00 €	201 09 250 4	867,00 €	36,7	1
280	10	201 03 280 4	630,00 €	201 09 280 4	890,00 €		1
315	10	201 03 315 4	1.310,00 €	201 09 315 4	1.835,00 €	44,5	1
355	6	201 03 355 4	4.485,00 €	201 09 355 4	①		1
400	6	201 03 400 4	4.485,00 €	201 09 400 4	①		1

304 Paslanmaz Civata-Somun-Pul / 304.S.S.Screw,Nut,Washer

Su İçin / For Water

Asit İçin / For Acid

Çap Dia	EPDM Conta Kod EPDM O-Ring Code	Fiyat (Adet) Price (Pcs)	FPM Conta Kod FPM O-Ring Code	Fiyat (Adet) Price (Pcs)
63	201 05 063 4	114,00 €	201 06 063 4	139,20 €
75	201 05 075 4	121,00 €	201 06 075 4	148,30 €
90	201 05 090 4	130,80 €	201 06 090 4	161,04 €
110	201 05 110 4	149,00 €	201 06 110 4	184,70 €
125	201 05 125 4	163,00 €	201 06 125 4	202,90 €
140	201 05 140 4	163,00 €	201 06 140 4	202,90 €
160	201 05 160 4	224,60 €	201 06 160 4	282,98 €
200	201 05 200 4	303,00 €	201 06 200 4	384,90 €
225	201 05 225 4	308,60 €	201 06 225 4	392,18 €
250	201 05 250 4	757,00 €	201 06 250 4	969,10 €
280	201 05 280 4	778,00 €	201 06 280 4	1.034,60 €
315	201 05 315 4	1.660,00 €	201 06 315 4	2.143,00 €
355	201 05 355 4	5.520,00 €	201 06 355 4	①
400	201 05 400 4	5.520,00 €	201 06 400 4	①

316 Paslanmaz Civata-Somun-Pul / 316.S.S.Screw,Nut,Washer

Su İçin / For Water

Asit İçin / For Acid

Çap Dia	EPDM Conta Kod EPDM O-Ring Code	Fiyat (Adet) Price (Pcs)	FPM Conta Kod FPM O-Ring Code	Fiyat (Adet) Price (Pcs)
63	201 07 063 4	156,00 €	201 08 063 4	206,40 €
75	201 07 075 4	166,50 €	201 08 075 4	221,10 €
90	201 07 090 4	181,20 €	201 08 090 4	241,68 €
110	201 07 110 4	208,50 €	201 08 110 4	279,90 €
125	201 07 125 4	229,50 €	201 08 125 4	309,30 €
140	201 07 140 4	229,50 €	201 08 140 4	309,30 €
160	201 07 160 4	321,90 €	201 08 160 4	438,66 €
200	201 07 200 4	439,50 €	201 08 200 4	603,30 €
225	201 07 225 4	447,90 €	201 08 225 4	615,05 €
250	201 07 250 4	1.140,50 €	201 08 250 4	1.534,70 €
280	201 07 280 4	1.162,00 €	201 08 280 4	1.598,80 €
315	201 07 315 4	2.465,00 €	201 08 315 4	3.431,00 €
355	201 07 355 4	6.555,00 €	201 08 355 4	①
400	201 07 400 4	6.555,00 €	201 08 400 4	①

Çap Dia	DN	D (mm)	Z (mm)	Z1 (mm)	Z2 (mm)	B (mm)	L (mm)	Q1 (mm)	Q2 (mm)	nØe	ISO 5211 ISO 5211	kv-value l/min.
63	50	165	51	82	196	38	192	37		4 x 19	F 07	1470
75	65	185	52	92	191	43	192	50	40	4 x 19	F 07	2200
90	80	200	58	100	190	51	192	65	46	8 x 19	F 07	3000
110	100	220	66	110	227	60	192	85	68	8 x 19	F 07	6500
125	110	250	73	125	228	69	192	111	92	8 x 23	F 07	11500
140	125	250	73	125	228	75	192	111	92	8 x 23	F 07	11500
160	150	285	76	142	232	86	192	138	122	8 x 24	F 07	16600
200	175	340	87	170	259	106	192	192	179	8 x 24	F 07	39600
225	200	340	87	170	259	120	192	192	179	8 x 24	F 07	39600
250	250	395	123	198	287	131	250	223	209	8 x 24	F 10	55200
280	250	395	119	198	287	146	250	223	209	12 x 24	F 10	55200
315	300	445	121	228	353	164	250	256	253	12 x 24	F 10	80000
355	350	505	140	255	372	185	300	325	305	16 x 24	F 12	90000
400	400	565	169	285	402	206	300	353	350	16 x 26	F 12	115000

Not / Note

U-PVC

AKTÜATÖRLÜ KELEBEK VANA ACTUATOR BUTTERFLY VALVE

ÜRETİM STANDARDI

PRODUCTION STANDARD

TS EN ISO 16136

ÇAP / SIZE Ø63 - Ø400

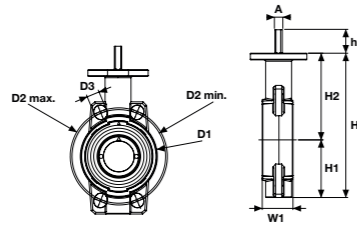

U-PVC Aktüatör Uyumlu Kelebek Vana (Çıplak)
 U-PVC Actuator Mountable Butterfly Valves (Without Flange)

Su İçin / For Water
Asit İçin / For Acid

Çap Dia	Basınç PN	EPDM Conta Kod EPDM O-Ring Code	Fiyat (Adet) Price (Pcs)	FPM Conta Kod FPM O-Ring Code	Fiyat (Adet) Price (Pcs)	Kg /Adet Kg/Pcs	Koli/Ad. Box/Pcs
63	10	300 00 063 4	38,95 €	300 01 063 4	58,43 €		1
75	10	300 00 075 4	42,75 €	300 01 075 4	64,13 €		1
90	10	300 00 090 4	45,60 €	300 01 090 4	68,40 €		1
110	10	300 00 110 4	52,25 €	300 01 110 4	78,38 €		1
125	10	300 00 125 4	58,90 €	300 01 125 4	88,35 €		1
140	10	300 00 140 4	58,90 €	300 01 140 4	88,35 €		1
160	10	300 00 160 4	75,05 €	300 01 160 4	112,58 €		1
200	10	300 00 200 4	125,40 €	300 01 200 4	188,10 €		1
225	10	300 00 225 4	125,40 €	300 01 225 4	188,10 €		1
250	10	300 00 250 4	332,50 €	300 01 250 4	498,75 €		1
280	10	300 00 280 4	332,50 €	300 01 280 4	498,75 €		1
315	10	300 00 315 4	855,00 €	300 01 315 4	1.282,50 €		1
355	6	300 00 355 4	Ⓜ	300 01 355 4	Ⓜ		1
400	6	300 00 400 4	Ⓜ	300 01 400 4	Ⓜ		1

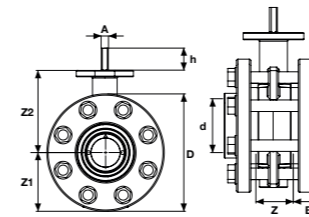
Çap Dia	DN (mm)	D1 (mm)	D2 min. (mm)	D2 max. (mm)	D3 (mm)	H (mm)	H1 (mm)	H2 (mm)	W1 (mm)	A (mm)	h (mm)	nØe	kv-value l/min.	ISO 5211 ISO 5211
63	50	104	120	125	19	256	82	126	45	11	15	4 x 19	1470	F 07
75	65	115	140	145	19	265	86	129	46	11	15	4 x 19	2200	F 07
90	80	131	150	160	19	272	89	132	48	11	15	8 x 19	3000	F 07
110	100	160	175	190	19	311	103	156	56	14	15	8 x 19	6500	F 07
125	110	190	210	216	23	338	116	169	63	14	15	8 x 23	11500	F 07
140	125	190	210	216	23	338	116	169	63	14	15	8 x 23	11500	F 07
160	150	214	241	241	24	364	129	182	66	14	15	8 x 24	16600	F 07
200	175	268	290	295	24	414	158	203	75	17	15	8 x 24	39600	F 07
225	200	268	290	295	24	414	158	203	75	17	15	8 x 24	39600	F 07
250	250	333	353	362	24	507	198	242	114	17	20	8 x 24	55200	F 10
280	250	333	353	362	24	507	198	242	114	17	20	12 x 24	55200	F 10
315	300	379	400	432	24	580	228	285	113	22	20	12 x 24	80000	F 10
355	350	535	445	477	26	620	268	305	140	22	20	16 x 24	90000	F 12
400	400	595	510	540	26	686	285	335	168	22	20	16 x 26	115000	F 12

U-PVC Aktüatör Uyumlu Kelebek Vana (Takım)
 U-PVC Actuator Mountable Butterfly Valves (With Flange Adaptor)

Su İçin / For Water
Asit İçin / For Acid

Çap Dia	Basınç PN	EPDM Conta Kod EPDM O-Ring Code	Fiyat (Adet) Price (Pcs)	FPM Conta Kod FPM O-Ring Code	Fiyat (Adet) Price (Pcs)	Kg /Adet Kg/Pcs	Koli/Ad. Box/Pcs
63	10	301 00 063 4	57,00 €	301 01 063 4	85,50 €		1
75	10	301 00 075 4	61,75 €	301 01 075 4	92,63 €		1
90	10	301 00 090 4	68,40 €	301 01 090 4	102,60 €		1
110	10	301 00 110 4	80,75 €	301 01 110 4	115,43 €		1
125	10	301 00 125 4	90,25 €	301 01 125 4	135,38 €		1
140	10	301 00 140 4	90,25 €	301 01 140 4	135,38 €		1
160	10	301 00 160 4	132,05 €	301 01 160 4	198,08 €		1
200	10	301 00 200 4	185,25 €	301 01 200 4	277,88 €		1
225	10	301 00 225 4	189,05 €	301 01 225 4	283,58 €		1
250	10	301 00 250 4	479,75 €	301 01 250 4	719,15 €		1
280	10	301 00 280 4	494,00 €	301 01 280 4	741,00 €		1
315	10	301 00 315 4	1.092,50 €	301 01 315 4	1.638,75 €		1
355	6	301 00 355 4	Ⓜ	301 01 355 4	Ⓜ		1
400	6	301 00 400 4	Ⓜ	301 01 400 4	Ⓜ		1

304 Paslanmaz Civata-Somun-Pul / 304.S.S.Screw,Nut,Washer
Su İçin / For Water
Asit İçin / For Acid

Çap Dia	EPDM Conta Kod EPDM O-Ring Code	Fiyat (Adet) Price (Pcs)	FPM Conta Kod FPM O-Ring Code	Fiyat (Adet) Price (Pcs)
63	308 00 063 2	81,48 €	308 10 063 2	105,92 €
75	308 00 075 2	88,27 €	308 10 075 2	114,75 €
90	308 00 090 2	97,78 €	308 10 090 2	127,11 €
110	308 00 110 2	115,43 €	308 10 110 2	150,06 €
125	308 00 125 2	129,01 €	308 10 125 2	167,71 €
140	308 00 140 2	129,01 €	308 10 140 2	167,71 €
160	308 00 160 2	188,76 €	308 10 160 2	245,39 €
200	308 00 200 2	264,81 €	308 10 200 2	344,25 €
225	308 00 225 2	270,24 €	308 10 225 2	351,31 €
250	308 00 250 2	685,79 €	308 10 250 2	891,53 €
280	308 00 280 2	706,16 €	308 10 280 2	935,66 €
315	308 00 315 2	1.561,70 €	308 10 315 2	2.030,21 €
355	308 00 355 2	Ⓜ	308 10 355 2	Ⓜ
400	308 00 400 2	Ⓜ	308 10 400 2	Ⓜ

316 Paslanmaz Civata-Somun-Pul / 316.S.S.Screw,Nut,Washer
Su İçin / For Water
Asit İçin / For Acid

Çap Dia	EPDM Conta Kod EPDM O-Ring Code	Fiyat (Adet) Price (Pcs)	FPM Conta Kod FPM O-Ring Code	Fiyat (Adet) Price (Pcs)
63	309 00 063 2	81,48 €	309 10 063 2	105,92 €
75	309 00 075 2	88,27 €	309 10 075 2	114,75 €
90	309 00 090 2	97,78 €	309 10 090 2	127,11 €
110	309 00 110 2	115,43 €	309 10 110 2	150,06 €
125	309 00 125 2	129,01 €	309 10 125 2	167,71 €
140	309 00 140 2	129,01 €	309 10 140 2	167,71 €
160	309 00 160 2	188,76 €	309 10 160 2	245,39 €
200	309 00 200 2	264,81 €	309 10 200 2	344,25 €
225	309 00 225 2	270,24 €	309 10 225 2	351,31 €
250	309 00 250 2	685,79 €	309 10 250 2	891,53 €
280	309 00 280 2	706,16 €	309 10 280 2	935,66 €
315	309 00 315 2	1.561,70 €	309 10 315 2	2.030,21 €
355	309 00 355 2	Ⓜ	309 10 355 2	Ⓜ
400	309 00 400 2	Ⓜ	309 10 400 2	Ⓜ

Çap Dia	DN (mm)	D (mm)	Z (mm)	Z1 (mm)	Z2 (mm)	B (mm)	Q1 (mm)	Q2 (mm)	A (mm)	h (mm)	nØe	ISO 5211 ISO 5211	kv-value l/min.
63	50	54	51	82	188	38	37	-	11	15	4 x 19	F 07	1470
75	65	57	52	92	180	43	50	40	11	15	4 x 19	F 07	2200
90	80	131	58	100	183	51	65	46	11	15	8 x 19	F 07	3000
110	100	160	66	110	208	60	85	68	14	15	8 x 19	F 07	6500
125	110	190	73	125	221	69	111	92	14	15	8 x 23	F 07	11500
140	125	190	73	125	221	75	111	92	14	15	8 x 23	F 07	11500
160	150	214	76	142	235	86	138	122	14	15	8 x 24	F 07	16600
200	175	268	87	170	255	106	192	179	17	15	8 x 24	F 07	39600
225	200	268	87	170	255	120	192	179	17	15	8 x 24	F 07	39600
250	250	333	123	198	309	131	223	209	17	20	8 x 24	F 10	55200
280	250	333	119	198	309	146	223	209	17	20	12 x 24	F 10	55200
315	300	379	121	228	370	164	256	253	22	20	12 x 24	F 10	80000
355	350	505	140	255	372	185	325	305	22	20	16 x 24	F 12	90000
400	400	565	169	285	402	206	353	350	22	20	16 x 26	F 12	115000

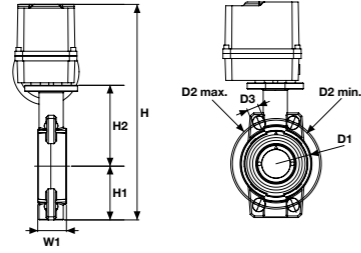
U-PVC Elektrik Aktüatörlü Kelebek Vana 24 V DC/24 V AC (Çıplak)
 U-PVC Butterfly Valve Electric Actuator 24 V DC/24 V AC (Without Flange)

Su için / For Water

Asit için / For Acid

Çap Dia	Basınç PN	EPDM Conta Kod EPDM O-Ring Code	Fiyat (Adet) Price (Pcs)	FPM Conta Kod FPM O-Ring Code	Fiyat (Adet) Price (Pcs)	Kg /Adet Kg/Pcs	Koli/Ad. Box/Pcs
63	10	302 00 063 4	296,94 €	302 01 063 4	317,44 €		1
75	10	302 00 075 4	296,94 €	302 01 075 4	319,14 €		1
90	10	302 00 090 4	404,84 €	302 01 090 4	428,84 €		1
110	10	302 00 110 4	411,99 €	302 01 110 4	439,49 €		1
125	10	302 00 125 4	706,48 €	302 01 125 4	737,48 €		1
140	10	302 00 140 4	706,48 €	302 01 140 4	737,48 €		1
160	10	302 00 160 4	723,24 €	302 01 160 4	762,74 €		1
200	10	302 00 200 4	800,08 €	302 01 200 4	866,08 €		1
225	10	302 00 225 4	800,08 €	302 01 225 4	866,08 €		1
250	10	302 00 250 4	1.501,36 €	302 01 250 4	1.676,36 €		1
280	10	302 00 280 4	1.501,36 €	302 01 280 4	1.676,36 €		1
315	10	302 00 315 4	2.059,96 €	302 01 315 4	2.509,96 €		1
355	6	302 00 355 4	①	302 01 355 4	①		1
400	6	302 00 400 4	①	302 01 400 4	①		1

Çap Dia	DN (mm)	D1 (mm)	D2 min. (mm)	D2 max. (mm)	D3 (mm)	H (mm)	H1 (mm)	H2 (mm)	W1 (mm)	nØe	kv-value l/min.	ISO 5211 ISO 5211
63	50	54	120	125	19	446	77	134	45	4 x 19	1470	F 07
75	65	57	140	145	19	451	86	129	46	4 x 19	2200	F 07
90	80	131	150	160	19	457	89	132	48	8 x 19	3000	F 07
110	100	160	175	190	19	504	103	156	56	8 x 19	6500	F 07
125	110	190	210	216	23	520	116	169	63	8 x 23	11500	F 07
140	125	190	210	216	23	520	116	169	63	8 x 23	11500	F 07
160	150	214	241	241	24	546	129	182	66	8 x 24	16600	F 07
200	175	268	290	295	24	596	158	203	75	8 x 24	39600	F 07
225	200	268	290	295	24	596	158	203	75	8 x 24	39600	F 07
250	250	333	341	362	24	748	198	242	114	8 x 24	55200	F 10
280	250	333	341	362	24	748	198	242	114	12 x 24	55200	F 10
315	300	379	400	432	25	923	228	285	113	12 x 24	80000	F 10
355	350	535	445	477	26	620	268	305	140	16 x 24	90000	F 12
400	400	595	510	540	26	686	285	335	168	16 x 26	115000	F 12

Opsiyonlar: Akülü açma/kapama emniyet kumandalı olabilir. Oransal kontrol ünitesi, potansiyometre, lokal kontrol ünitesi, pozisyon transmiyeri opsiyonları mevcuttur.

Boru flanş bağlantı ölçüleri: EN 1092 PN10, ISO 7005 PN10, ANSI B 16,5 class 150, BS 1560 1958

Aktüatör flanş bağlantı ölçüleri: ISO 5211/24V DC - 24V AC.

Options: Battery powered on/off can be safety controlled. Option control unit, potentiometer, local control unit, position transmitter options are available.

Pipe flange connection dimensions: EN 1092 PN10, ISO 7005 PN10, ANSI B 16,5 class 150, BS 1560 1958

Actuator flange connection measures: ISO 5211/24V DC - 24V AC.

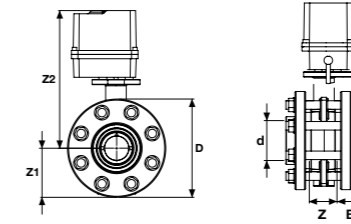
U-PVC Elektrik Aktüatörlü Kelebek Vana 24 V DC/24 V AC (Takım)
 U-PVC Butterfly Valve Electric Actuator 24 V DC/24 V AC (With Flange Adaptor)

Su için / For Water

Asit için / For Acid

Çap Dia	Basınç PN	EPDM Conta Kod EPDM O-Ring Code	Fiyat (Adet) Price (Pcs)	FPM Conta Kod FPM O-Ring Code	Fiyat (Adet) Price (Pcs)	Kg /Adet Kg/Pcs	Koli/Ad. Box/Pcs
63	10	304 00 063 4	315,94 €	304 01 063 4	345,94 €		1
75	10	304 00 075 4	316,64 €	304 01 075 4	349,14 €		1
90	10	304 00 090 4	428,84 €	304 01 090 4	464,84 €		1
110	10	304 00 110 4	437,99 €	304 01 110 4	478,49 €		1
125	10	304 00 125 4	739,48 €	304 01 125 4	786,98 €		1
140	10	304 00 140 4	739,48 €	304 01 140 4	786,98 €		1
160	10	304 00 160 4	783,24 €	304 01 160 4	852,74 €		1
200	10	304 00 200 4	863,08 €	304 01 200 4	960,58 €		1
225	10	304 00 225 4	867,08 €	304 01 225 4	966,58 €		1
250	10	304 00 250 4	1.656,36 €	304 01 250 4	1.908,86 €		1
280	10	304 00 280 4	1.674,36 €	304 01 280 4	1.931,36 €		1
315	10	304 00 315 4	2.309,96 €	304 01 315 4	2.884,96 €		1
355	6	304 00 355 4	①	304 01 355 4	①		1
400	6	304 00 400 4	①	304 01 400 4	①		1

Çap Dia	DN (mm)	D (mm)	Z (mm)	Z1 (mm)	Z2 (mm)	B (mm)	nØe	ISO 5211 ISO 5211
63	50	165	51	83	395	38	4 x 19	F 07
75	65	185	52	93	399	43	4 x 19	F 07
90	80	200	58	100	398	51	8 x 19	F 07
110	100	220	66	110	438	60	8 x 19	F 07
125	110	250	73	125	447	69	8 x 23	F 07
140	125	250	73	125	447	75	8 x 23	F 07
160	150	285	76	143	459	86	8 x 24	F 07
200	175	340	87	170	509	106	8 x 24	F 07
225	200	340	87	170	509	120	8 x 24	F 07
250	250	395	123	198	625	131	8 x 24	F 10
280	250	395	119	198	629	146	12 x 24	F 10
315	300	445	121	228	802	164	12 x 24	F 10
355	350	505	140	255	372	185	16 x 24	F 12
400	400	565	169	285	402	206	16 x 26	F 12

Opsiyonlar: Akülü açma/kapama emniyet kumandalı olabilir. Oransal kontrol ünitesi, potansiyometre, lokal kontrol ünitesi, pozisyon transmiyeri opsiyonları mevcuttur.

Boru flanş bağlantı ölçüleri: EN 1092 PN10, ISO 7005 PN10, ANSI B 16,5 class 150, BS 1560 1958

Aktüatör flanş bağlantı ölçüleri: ISO 5211/24V DC - 24V AC.

Options: Battery powered on/off can be safety controlled. Option control unit, potentiometer, local control unit, position transmitter options are available.

Pipe flange connection dimensions: EN 1092 PN10, ISO 7005 PN10, ANSI B 16,5 class 150, BS 1560 1958

Actuator flange connection measures: ISO 5211/24V DC - 24V AC.

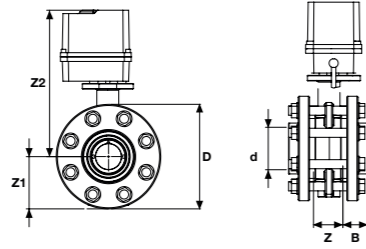
U-PVC Elektrik Aktüatörlü Kelebek Vana 24 V DC/24 V AC 304/316 Paslanmaz Civata-Somun-Pul
 U-PVC Butterfly Valves With Flange 304/316 S.S. Screw, Nut, Washer Electric Actuator 24 V DC/24 V AC

304 Paslanmaz Civata-Somun-Pul / 304.S.S.Screw,Nut,Washer

Çap Dia	Su için / For Water		Asit için / For Acid	
	EPDM Conta Kod EPDM O-Ring Code	Fiyat (Adet) Price (Pcs)	FPM Conta Kod FPM O-Ring Code	Fiyat (Adet) Price (Pcs)
63	306 00 063 4	339,94 €	306 01 063 4	365,14 €
75	306 00 075 4	342,64 €	306 01 075 4	369,94 €
90	306 00 090 4	457,64 €	306 01 090 4	488,24 €
110	306 00 110 4	470,39 €	306 01 110 4	504,41 €
125	306 00 125 4	777,48 €	306 01 125 4	817,38 €
140	306 00 140 4	777,48 €	306 01 140 4	817,38 €
160	306 00 160 4	838,84 €	306 01 160 4	897,22 €
200	306 00 200 4	941,08 €	306 01 200 4	1.022,98 €
225	306 00 225 4	946,68 €	306 01 225 4	1.030,26 €
250	306 00 250 4	1.858,36 €	306 01 250 4	2.070,46 €
280	306 00 280 4	1.879,36 €	306 01 280 4	2.115,96 €
315	306 00 315 4	2.769,96 €	306 01 315 4	3.552,96 €
355	306 00 355 4	Ⓜ	306 01 355 4	Ⓜ
400	306 00 400 4	Ⓜ	306 01 400 4	Ⓜ

316 Paslanmaz Civata-Somun-Pul / 316.S.S.Screw,Nut,Washer

Çap Dia	Su için / For Water		Asit için / For Acid	
	EPDM Conta Kod EPDM O-Ring Code	Fiyat (Adet) Price (Pcs)	FPM Conta Kod FPM O-Ring Code	Fiyat (Adet) Price (Pcs)
63	308 00 063 4	381,94 €	308 01 063 4	432,34 €
75	308 00 075 4	388,14 €	308 01 075 4	442,74 €
90	308 00 090 4	508,04 €	308 01 090 4	568,52 €
110	308 00 110 4	535,49 €	308 01 110 4	606,89 €
125	308 00 125 4	843,98 €	308 01 125 4	923,78 €
140	308 00 140 4	843,98 €	308 01 140 4	923,78 €
160	308 00 160 4	936,14 €	308 01 160 4	1.052,90 €
200	308 00 200 4	1.077,58 €	308 01 200 4	1.241,38 €
225	308 00 225 4	1.085,98 €	308 01 225 4	1.253,14 €
250	308 00 250 4	2.211,86 €	308 01 250 4	2.636,06 €
280	308 00 280 4	2.243,36 €	308 01 280 4	2.680,16 €
315	308 00 315 4	3.574,96 €	308 01 315 4	4.540,96 €
355	308 00 355 4	Ⓜ	308 01 355 4	Ⓜ
400	308 00 400 4	Ⓜ	308 01 400 4	Ⓜ

Çap Dia	DN (mm)	D (mm)	Z (mm)	Z1 (mm)	Z2 (mm)	B (mm)	Q1 (mm)	Q2 (mm)	nØe	ISO 5211 ISO 5211	Basınç PN	kv-value l/min.	Kg /Adet Kg/Pcs	Koli/Ad. Box/Pcs
63	50	165	51	82	395	38	37		4 x 19	F 07	10	1470		1
75	65	185	52	92	399	43	50	40	4 x 19	F 07	10	2200		1
90	80	200	58	100	398	51	65	46	8 x 19	F 07	10	3000		1
110	100	220	66	110	438	60	85	68	8 x 19	F 07	10	6500		1
125	110	250	73	125	447	69	111	92	8 x 23	F 07	10	11500		1
140	125	250	73	125	447	75	111	92	8 x 23	F 07	10	11500		1
160	150	285	76	142	459	86	138	122	8 x 24	F 07	10	16600		1
200	175	340	87	170	509	106	192	179	8 x 24	F 07	10	39600		1
225	200	340	87	170	509	120	192	179	8 x 24	F 07	10	39600		1
250	250	395	123	198	625	131	223	209	8 x 24	F 10	10	55200		1
280	250	395	119	198	629	146	223	209	12 x 24	F 10	10	55200		1
315	300	445	121	228	802	164	256	253	12 x 24	F 10	10	80000		1
355	350	505	140	255	372	185	325	305	16 x 24	F 12	6	90000		1
400	400	565	169	285	402	206	353	350	16 x 26	F 12	6	115000		1

Opsiyonlar: Akülü açma/kapama emniyet kumandalı olabilir. Oransal kontrol ünitesi, potansiyonometre, lokal kontrol ünitesi, pozisyon transmiyeri opsiyonları mevcuttur.

Boru flanş bağlantı ölçüleri: EN 1092 PN10, ISO 7005 PN10, ANSI B 16,5 class 150, BS 1560 1958

Aktüatör flanş bağlantı ölçüleri: ISO 5211/24V DC - 24V AC.

Options: Battery powered on/off can be safety controlled. Option control unit, potentiometer, local control unit, position transmitter options are available.

Pipe flange connection dimensions: EN 1092 PN10, ISO 7005 PN10, ANSI B 16,5 class 150, BS 1560 1958

Actuator flange connection measures: ISO 5211/24V DC - 24V AC.

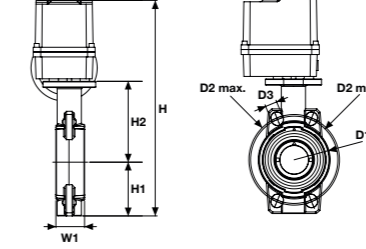
U-PVC Elektrik Aktüatörlü Kelebek Vana 100-260 V AC (Çıplak)
 U-PVC Butterfly Valves Electric Actuator 100 -260 V AC (With Out Flange)

Çap Dia	Basınç PN	Su için / For Water		Asit için / For Acid		Kg /Adet Kg/Pcs	Koli/Ad. Box/Pcs
		EPDM Conta Kod EPDM O-Ring Code	Fiyat (Adet) Price (Pcs)	FPM Conta Kod FPM O-Ring Code	Fiyat (Adet) Price (Pcs)		
63	10	303 00 063 1	298,20 €	303 10 063 1	317,44 €		1
75	10	303 00 075 1	296,94 €	303 10 075 1	319,14 €		1
90	10	303 00 090 1	404,84 €	303 10 090 1	428,84 €		1
110	10	303 00 110 1	411,99 €	303 10 110 1	439,49 €		1
125	10	303 00 125 1	706,48 €	303 10 125 1	737,48 €		1
140	10	303 00 140 1	706,48 €	303 10 140 1	737,48 €		1
160	10	303 00 160 1	723,24 €	303 10 160 1	762,74 €		1
200	10	303 00 200 1	800,08 €	303 10 200 1	866,08 €		1
225	10	303 00 225 1	800,08 €	303 10 225 1	866,08 €		1
250	10	303 00 250 1	1.501,36 €	303 10 250 1	1.676,36 €		1
280	10	303 00 280 1	1.501,36 €	303 10 280 1	1.676,36 €		1
315	10	303 00 315 1	2.059,96 €	303 10 315 1	2.509,96 €		1
355	6	303 00 355 1	Ⓜ	303 10 355 1	Ⓜ		1
400	6	303 00 400 1	Ⓜ	303 10 400 1	Ⓜ		1

Çap Dia	DN (mm)	D (mm)	Z (mm)	Z1 (mm)	Z2 (mm)	B (mm)	nØe	ISO 5211 ISO 5211
63	50	165	51	83	395	38	4 x 19	F 07
75	65	185	52	93	399	43	4 x 19	F 07
90	80	200	58	100	398	51	8 x 19	F 07
110	100	220	66	110	438	60	8 x 19	F 07
125	110	250	73	125	447	69	8 x 23	F 07
140	125	250	73	125	447	75	8 x 23	F 07
160	150	285	76	143	459	86	8 x 24	F 07
200	175	340	87	170	509	106	8 x 24	F 07
225	200	340	87	170	509	120	8 x 24	F 07
250	250	395	123	198	625	131	8 x 24	F 10
280	250	395	119	198	629	146	12 x 24	F 10
315	300	445	121	228	802	164	12 x 24	F 10
355	350	505	140	255	372	185	16 x 24	F 12
400	400	565	169	285	402	206	16 x 26	F 12

Opsiyonlar: Akülü açma/kapama emniyet kumandalı olabilir. Oransal kontrol ünitesi, potansiyonometre, lokal kontrol ünitesi, pozisyon transmiyeri opsiyonları mevcuttur.

Boru flanş bağlantı ölçüleri: EN 1092 PN10, ISO 7005 PN10, ANSI B 16,5 class 150, BS 1560 1958

Aktüatör flanş bağlantı ölçüleri: ISO 5211/24V DC - 24V AC.

Options: Battery powered on/off can be safety controlled. Option control unit, potentiometer, local control unit, position transmitter options are available.

Pipe flange connection dimensions: EN 1092 PN10, ISO 7005 PN10, ANSI B 16,5 class 150, BS 1560 1958

Actuator flange connection measures: ISO 5211/24V DC - 24V AC.

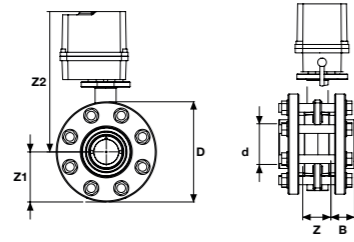
U-PVC Elektrik Aktüatörlü Kelebek Vana 100-260 V AC (Takım)
 U-PVC Butterfly Valves Electric Actuator 100 -260 V AC (With Flange)

Su İçin / For Water
Asit İçin / For Acid

Çap Dia	Basınç PN	EPDM Conta Kod EPDM O-Ring Code	Fiyat (Adet) Price (Pcs)	FPM Conta Kod FPM O-Ring Code	Fiyat (Adet) Price (Pcs)	Kg /Adet Kg/Pcs	Koli/Ad. Box/Pcs
63	10	305 00 063 4	315,94 €	305 01 063 4	345,94 €	3,10	1
75	10	305 00 075 4	316,64 €	305 01 075 4	349,14 €	3,33	1
90	10	305 00 090 4	428,84 €	305 01 090 4	464,84 €	3,83	1
110	10	305 00 110 4	437,99 €	305 01 110 4	478,49 €	4,32	1
125	10	305 00 125 4	739,48 €	305 01 125 4	786,98 €	6,60	1
140	10	305 00 140 4	739,48 €	305 01 140 4	786,98 €	8,95	1
160	10	305 00 160 4	783,24 €	305 01 160 4	852,74 €	9,18	1
200	10	305 00 200 4	863,08 €	305 01 200 4	960,58 €	12,2	1
225	10	305 00 225 4	867,08 €	305 01 225 4	966,58 €	14,9	1
250	10	305 00 250 4	1.656,36 €	305 01 250 4	1.908,86 €	28,5	1
280	10	305 00 280 4	1.671,36 €	305 01 280 4	1.931,36 €	28,5	1
315	10	305 00 315 4	2.309,96 €	305 01 315 4	2.884,96 €	36,1	1
355	6	305 00 355 4	Ⓜ	305 01 355 4	Ⓜ		1
400	6	305 00 400 4	Ⓜ	305 01 400 4	Ⓜ		1

Çap Dia	DN (mm)	D (mm)	Z (mm)	Z1 (mm)	Z2 (mm)	B (mm)	nØe	ISO 5211 ISO 5211
63	50	165	51	83	395	38	4 x 19	F 07
75	65	185	52	93	399	43	4 x 19	F 07
90	80	200	58	100	398	51	8 x 19	F 07
110	100	220	66	110	438	60	8 x 19	F 07
125	110	250	73	125	447	69	8 x 23	F 07
140	125	250	73	125	447	75	8 x 23	F 07
160	150	285	76	143	459	86	8 x 24	F 07
200	175	340	87	170	509	106	8 x 24	F 07
225	200	340	87	170	509	120	8 x 24	F 07
250	250	395	123	198	625	131	8 x 24	F 10
280	250	395	119	198	629	146	12 x 24	F 10
315	300	445	121	228	802	164	12 x 24	F 10
355	350	505	140	255	372	185	16 x 24	F 12
400	400	565	169	285	402	206	16 x 26	F 12

Opsiyonlar: Akülü açma/kapama emniyet kumandalı olabilir. Oransal kontrol ünitesi, potansiyometre, lokal kontrol ünitesi, pozisyon transmitteri opsiyonları mevcuttur.

Boru flanş bağlantı ölçüleri: EN 1092 PN10, ISO 7005 PN10, ANSI B 16,5 class 150, BS 1560 1958

Aktüatör flanş bağlantı ölçüleri: ISO 5211/24V DC - 24V AC.

Options: Battery powered on/off can be safety controlled. Option control unit, potentiometer, local control unit, position transmitter options are available.

Pipe flange connection dimensions: EN 1092 PN10, ISO 7005 PN10, ANSI B 16,5 class 150, BS 1560 1958

Actuator flange connection measures: ISO 5211/24V DC - 24V AC.

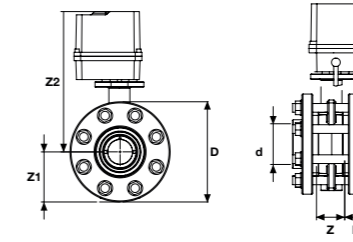
U-PVC Elektrik Aktüatörlü Kelebek Vana 100-260 V AC 304/316 Paslanmaz Civata-Somun-Pul
 U-PVC Butterfly Valves Electric Actuator 100 -260 V AC 304/316 Stainless Steel Screw-Nut-Washer (With Flange)

304 Paslanmaz Civata-Somun-Pul / 304.S.S.Screw,Nut,Washer
316 Paslanmaz Civata-Somun-Pul / 316.S.S.Screw,Nut,Washer
Su İçin / For Water
Asit İçin / For Acid

Çap Dia	EPDM Conta Kod EPDM O-Ring Code	Fiyat (Adet) Price (Pcs)	FPM Conta Kod FPM O-Ring Code	Fiyat (Adet) Price (Pcs)	Çap Dia	EPDM Conta Kod EPDM O-Ring Code	Fiyat (Adet) Price (Pcs)	FPM Conta Kod FPM O-Ring Code	Fiyat (Adet) Price (Pcs)
63	307 00 063 4	339,94 €	307 01 063 4	365,14 €	63	309 00 063 4	381,94 €	309 01 063 4	432,34 €
75	307 00 075 4	342,64 €	307 01 075 4	369,94 €	75	309 00 075 4	388,14 €	309 01 075 4	442,74 €
90	307 00 090 4	457,64 €	307 01 090 4	488,24 €	90	309 00 090 4	508,04 €	309 01 090 4	568,52 €
110	307 00 110 4	470,39 €	307 01 110 4	504,41 €	110	309 00 110 4	535,49 €	309 01 110 4	606,89 €
125	307 00 125 4	777,48 €	307 01 125 4	817,38 €	125	309 00 125 4	843,98 €	309 01 125 4	923,78 €
140	307 00 140 4	777,48 €	307 01 140 4	817,38 €	140	309 00 140 4	843,98 €	309 01 140 4	923,78 €
160	307 00 160 4	838,84 €	307 01 160 4	897,22 €	160	309 00 160 4	936,14 €	309 01 160 4	1.052,90 €
200	307 00 200 4	941,08 €	307 01 200 4	1.022,98 €	200	309 00 200 4	1.077,58 €	309 01 200 4	1.241,38 €
225	307 00 225 4	946,68 €	307 01 225 4	1.030,26 €	225	309 00 225 4	1.085,98 €	309 01 225 4	1.253,14 €
250	307 00 250 4	1.858,36 €	307 01 250 4	2.070,46 €	250	309 00 250 4	2.211,86 €	309 01 250 4	2.636,06 €
280	307 00 280 4	1.879,36 €	307 01 280 4	2.115,96 €	280	309 00 280 4	2.243,36 €	309 01 280 4	2.680,16 €
315	307 00 315 4	2.769,96 €	307 01 315 4	3.252,96 €	315	309 00 315 4	3.574,96 €	309 01 315 4	4.540,96 €
355	307 00 355 4	Ⓜ	307 01 355 4	Ⓜ	355	309 00 355 4	Ⓜ	309 01 355 4	Ⓜ
400	307 00 400 4	Ⓜ	307 01 400 4	Ⓜ	400	309 00 400 4	Ⓜ	309 01 400 4	Ⓜ

Çap Dia	DN (mm)	D (mm)	Z (mm)	Z1 (mm)	Z2 (mm)	B (mm)	Q1 (mm)	Q2 (mm)	nØe	ISO 5211 ISO 5211	Basınç PN	kv-value l/min.	Kg /Adet Kg/Pcs	Koli/Ad. Box/Pcs
63	50	165	51	82	395	38	37		4 x 19	F 07	10	1470	4,98	1
75	65	185	52	92	399	43	50	40	4 x 19	F 07	10	2200	5,58	1
90	80	200	58	100	398	51	65	46	8 x 19	F 07	10	3000	7,54	1
110	100	220	66	110	438	60	85	68	8 x 19	F 07	10	6500	9,65	1
125	110	250	73	125	447	69	111	92	8 x 23	F 07	10	11500	11,88	1
140	125	250	73	125	447	75	111	92	8 x 23	F 07	10	11500	14,63	1
160	150	285	76	142	459	86	138	122	8 x 24	F 07	10	16600	15,79	1
200	175	340	87	170	509	106	192	179	8 x 24	F 07	10	39600	24,69	1
225	200	340	87	170	509	120	192	179	8 x 24	F 07	10	39600	24,39	1
250	250	395	123	198	625	131	223	209	8 x 24	F 10	10	55200	45,56	1
280	250	395	119	198	629	146	223	209	12 x 24	F 10	10	55200	48,06	1
315	300	445	121	228	802	164	256	253	12 x 24	F 10	10	80000	56,32	1
355	350	505	140	255	372	185	325	305	16 x 24	F 12	6	90000		1
400	400	565	169	285	402	206	353	350	16 x 26	F 12	6	115000		1

Opsiyonlar: Akülü açma/kapama emniyet kumandalı olabilir. Oransal kontrol ünitesi, potansiyometre, lokal kontrol ünitesi, pozisyon transmitteri opsiyonları mevcuttur.

Boru flanş bağlantı ölçüleri: EN 1092 PN10, ISO 7005 PN10, ANSI B 16,5 class 150, BS 1560 1958

Aktüatör flanş bağlantı ölçüleri: ISO 5211/24V DC - 24V AC.

Options: Battery powered on/off can be safety controlled. Option control unit, potentiometer, local control unit, position transmitter options are available.

Pipe flange connection dimensions: EN 1092 PN10, ISO 7005 PN10, ANSI B 16,5 class 150, BS 1560 1958

Actuator flange connection measures: ISO 5211/24V DC - 24V AC.

U-PVC Pnömatik Aktüatörlü Kelebek Vana Çift Etkili (Çıplak)

U-PVC Pneumatic Actuator Butterfly Valves Double Effect Without Flange

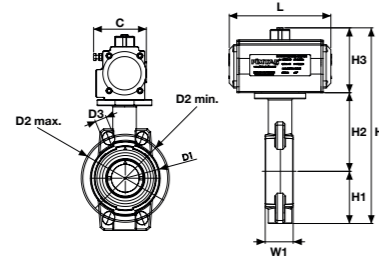

Su İçin / For Water

Asit İçin / For Acid

Çap Dia	Basınç PN	EPDM Conta Kod EPDM O-Ring Code	Fiyat (Adet) Price (Pcs)	FPM Conta Kod FPM O-Ring Code	Fiyat (Adet) Price (Pcs)	Kg /Adet Kg/Pcs	Koli/Ad. Box/Pcs
63	10	318 00 063 4	171,48 €	318 01 063 4	191,98 €	2,25	1
75	10	318 00 075 4	171,48 €	318 01 075 4	193,98 €	2,48	1
90	10	318 00 090 4	175,37 €	318 01 090 4	199,37 €	3,71	1
110	10	318 00 110 4	196,94 €	318 01 110 4	224,44 €	4,20	1
125	10	318 00 125 4	205,01 €	318 01 125 4	236,01 €	7,15	1
140	10	318 00 140 4	205,01 €	318 01 140 4	236,01 €	8,00	1
160	10	318 00 160 4	289,30 €	318 01 160 4	328,80 €	9,98	1
200	10	318 00 200 4	398,20 €	318 01 200 4	464,20 €	13,7	1
225	10	318 00 225 4	398,20 €	318 01 225 4	464,20 €	13,7	1
250	10	318 00 250 4	638,00 €	318 01 250 4	1.162,97 €	30,5	1
280	10	318 00 280 4	638,00 €	318 01 280 4	1.162,97 €	30,5	1
315	10	318 00 315 4	1.243,00 €	318 01 315 4	2.593,00 €	38,1	1
355	6	318 00 355 4	Ⓜ	318 01 355 4	Ⓜ		1
400	6	318 00 400 4	Ⓜ	318 01 400 4	Ⓜ		1

Çap Dia	DN (mm)	D1 (mm)	D2 min. (mm)	D2 max. (mm)	D3 (mm)	H (mm)	H1 (mm)	H2 (mm)	H3 (mm)	C (mm)	W1 (mm)	L (mm)	kv-value l/min.	ISO 5211
63	50	54	120	125	19	303	77	134	92	72	45	147	1470	F 07
75	65	57	140	145	19	307	86	129	92	72	46	147	2200	F 07
90	80	131	150	160	19	307	89	132	108	83	48	168	3000	F 07
110	100	160	175	190	19	379	103	156	120	95	56	184	6500	F 07
125	110	190	210	216	23	405	116	169	120	95	63	184	11500	F 07
140	125	190	210	216	23	405	116	169	120	100	63	184	11500	F 07
160	150	214	241	241	24	441	129	182	130	100	66	204	16600	F 07
200	175	268	290	295	24	501	158	203	140	108	75	262	39600	F 07
225	200	268	290	295	24	501	158	203	140	108	75	262	39600	F 07
250	250	333	341	362	24	593	198	242	153	122	114	268	55200	F 10
280	250	333	341	362	24	593	198	242	153	122	114	268	55200	F 10
315	300	379	400	432	25	668	228	285	175	142	113	296	80000	F 10
355	350	345	460	-	25	670	345	410	260	226	88	525	90000	F 12
400													115000	F 12

Opsiyonlar: Kolay montaj/demontaj imkanı, pozisyoner, limit anahtar kutusu, namur solenoid vana, el kontrol ünitesi.

Aktüatör flanş bağlantı ölçüleri: ISO 5211.

İhtiyaca göre opsiyon ilave edilebilir.

Options: Easy assembly/disassembly, potentiometer, limit switch box, namur solenoid valve, hand control unit.

Actuator flange connection dimensions: ISO 5211

Options could be add according to the needs.

U-PVC Pnömatik Aktüatörlü Kelebek Vana Çift Etkili (Takım)

U-PVC Pneumatic Actuator Butterfly Valves Double Effect With Flange

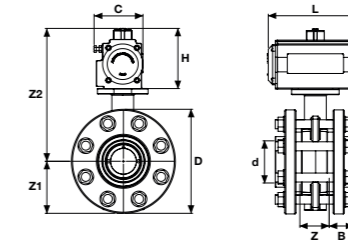

Su İçin / For Water

Asit İçin / For Acid

Çap Dia	Basınç PN	EPDM Conta Kod EPDM O-Ring Code	Fiyat (Adet) Price (Pcs)	FPM Conta Kod FPM O-Ring Code	Fiyat (Adet) Price (Pcs)	Kg /Adet Kg/Pcs	Koli/Ad. Box/Pcs
63	10	319 00 063 4	190,48 €	319 01 063 4	220,48 €	4,13	1
75	10	319 00 075 4	191,48 €	319 01 075 4	223,98 €	4,73	1
90	10	319 00 090 4	199,37 €	319 01 090 4	235,37 €	7,42	1
110	10	319 00 110 4	226,94 €	319 01 110 4	263,44 €	9,53	1
125	10	319 00 125 4	238,01 €	319 01 125 4	285,51 €	12,43	1
140	10	319 00 140 4	238,01 €	319 01 140 4	285,51 €	13,68	1
160	10	319 00 160 4	296,08 €	319 01 160 4	365,58 €	16,59	1
200	10	319 00 200 4	368,06 €	319 01 200 4	465,56 €	23,19	1
225	10	319 00 225 4	421,30 €	319 01 225 4	520,80 €	23,19	1
250	10	319 00 250 4	808,50 €	319 01 250 4	1.061,00 €	47,56	1
280	10	319 00 280 4	825,00 €	319 01 280 4	1.085,00 €	50,06	1
315	10	319 00 315 4	1.573,00 €	319 01 315 4	2.148,81 €	58,32	1
355	6	319 00 355 4	Ⓜ	319 01 355 4	Ⓜ		1
400	6	319 00 400 4	Ⓜ	319 01 400 4	Ⓜ		1

Çap Dia	DN (mm)	C (mm)	D (mm)	Z (mm)	Z1 (mm)	B (mm)	L (mm)	H (mm)	nØe (mm)	kv-value l/min.	ISO 5211
63	50	72	165	51	82	38	147	90	4 x 19	1470	F 07
75	65	72	185	52	92	43	147	90	4 x 19	2200	F 07
90	80	63	200	58	100	51	168	108	8 x 19	3000	F 07
110	100	95	220	66	110	60	184	120	8 x 19	6500	F 07
125	110	95	250	73	125	69	184	120	8 x 23	11500	F 07
140	125	100	250	73	125	75	184	120	8 x 23	11500	F 07
160	150	100	285	76	142	86	204	130	8 x 24	16600	F 07
200	175	108	340	87	170	106	262	140	8 x 24	39600	F 07
225	200	108	340	87	170	120	262	140	8 x 24	39600	F 07
250	250	122	395	123	198	131	268	153	8 x 24	55200	F 10
280	250	122	395	119	198	146	268	153	12 x 24	55200	F 10
315	300	142	445	121	228	164	296	175	12 x 24	80000	F 10
355										90000	
400										115000	

Opsiyonlar: Kolay montaj/demontaj imkanı, pozisyoner, limit anahtar kutusu, namur solenoid vana, el kontrol ünitesi.

Aktüatör flanş bağlantı ölçüleri: ISO 5211.

İhtiyaca göre opsiyon ilave edilebilir.

Options: Easy assembly/disassembly, potentiometer, limit switch box, namur solenoid valve, hand control unit.

Actuator flange connection dimensions: ISO 5211

Options could be add according to the needs.

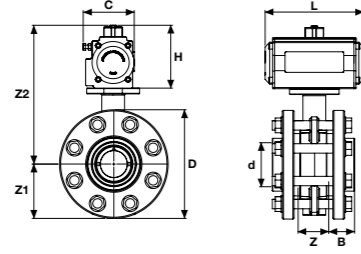
U-PVC Pnömatik Aktüatörlü Kelebek Vana Çift Etkili 304/316 Paslanmaz Civata-Somun-Pul
 U-PVC Pneumatic Actuator Butterfly Valves Double Effect 304/316 S.S. Screw, Nut, Washer

304 Paslanmaz Civata-Somun-Pul / 304.S.S.Screw,Nut,Washer

Çap Dia	Su İçin / For Water		Asit İçin / For Acid	
	EPDM Conta Kod EPDM O-Ring Code	Fiyat (Adet) Price (Pcs)	FPM Conta Kod FPM O-Ring Code	Fiyat (Adet) Price (Pcs)
63	320 00 063 4	214,48 €	320 01 063 4	239,68 €
75	320 00 075 4	217,48 €	320 01 075 4	244,78 €
90	320 00 090 4	228,17 €	320 01 090 4	258,41 €
110	320 00 110 4	255,34 €	320 01 110 4	296,64 €
125	320 00 125 4	276,01 €	320 01 125 4	315,91 €
140	320 00 140 4	276,01 €	320 01 140 4	315,91 €
160	320 00 160 4	351,68 €	320 01 160 4	410,06 €
200	320 00 200 4	446,06 €	320 01 200 4	527,96 €
225	320 00 225 4	451,66 €	320 01 225 4	535,24 €
250	320 00 250 4	935,65 €	320 01 250 4	1.147,75 €
280	320 00 280 4	956,65 €	320 01 280 4	1.193,25 €
315	320 00 315 4	1.892,09 €	320 01 315 4	2.375,09 €
355	320 00 355 4	Ⓟ	320 01 355 4	Ⓟ
400	320 00 400 4	Ⓟ	320 01 400 4	Ⓟ

316 Paslanmaz Civata-Somun-Pul / 316.S.S.Screw,Nut,Washer

Çap Dia	Su İçin / For Water		Asit İçin / For Acid	
	EPDM Conta Kod EPDM O-Ring Code	Fiyat (Adet) Price (Pcs)	FPM Conta Kod FPM O-Ring Code	Fiyat (Adet) Price (Pcs)
63	321 00 063 4	256,48 €	321 01 063 4	306,88 €
75	321 00 075 4	262,98 €	321 01 075 4	317,58 €
90	321 00 090 4	278,57 €	321 01 090 4	339,05 €
110	321 00 110 4	320,44 €	321 01 110 4	391,84 €
125	321 00 125 4	342,51 €	321 01 125 4	422,31 €
140	321 00 140 4	342,51 €	321 01 140 4	422,31 €
160	321 00 160 4	448,98 €	321 01 160 4	565,74 €
200	321 00 200 4	582,56 €	321 01 200 4	746,36 €
225	321 00 225 4	590,96 €	321 01 225 4	758,12 €
250	321 00 250 4	1.289,15 €	321 01 250 4	1.713,35 €
280	321 00 280 4	1.320,65 €	321 01 280 4	1.757,45 €
315	321 00 315 4	2.697,09 €	321 01 315 4	3.663,09 €
355	321 00 355 4	Ⓟ	321 01 355 4	Ⓟ
400	321 00 400 4	Ⓟ	321 01 400 4	Ⓟ

Çap Dia	DN (mm)	C (mm)	D (mm)	Z (mm)	Z1 (mm)	B (mm)	L (mm)	H (mm)	Q1 (mm)	Q2 (mm)	nØe (mm)	ISO 5211 ISO 5211	Basınç PN	kv-value l/min.	Kg /Adet Kg/Pcs	Koli/Ad. Box/Pcs
63	50	72	165	51	82	38	147	90	37		4 x 19	F 07	10	1470	4,13	1
75	65	72	185	52	92	43	147	90	50	40	4 x 19	F 07	10	2200	4,73	1
90	80	63	200	58	100	51	168	108	65	46	8 x 19	F 07	10	3000	7,42	1
110	100	95	220	66	110	60	184	120	85	68	8 x 19	F 07	10	6500	9,53	1
125	110	95	250	73	125	69	184	120	111	92	8 x 23	F 07	10	11500	12,43	1
140	125	100	250	73	125	75	184	120	111	92	8 x 23	F 07	10	11500	13,68	1
160	150	100	285	76	142	86	204	130	138	122	8 x 24	F 07	10	16600	16,59	1
200	175	108	340	87	170	106	262	140	192	179	8 x 24	F 07	10	39600	23,19	1
225	200	108	340	87	170	120	262	140	192	179	8 x 24	F 07	10	39600	23,19	1
250	250	122	395	123	198	131	268	153	223	209	8 x 24	F 10	10	55200	47,56	1
280	250	122	395	119	198	146	268	153	223	209	12 x 24	F 10	10	55200	50,06	1
315	300	142	445	121	228	164	296	175	256	253	12 x 24	F 10	10	80000	58,32	1
355									325	305			6	90000		1
400									353	350			6	115000		1

Opsiyonlar: Kolay montaj/demontaj imkanı, pozisyoner, limit anahtar kutusu, namur solenoid vana, el kontrol ünitesi.
Aktüatör flanş bağlantı ölçüleri: ISO 5211.
 İhtiyaca göre opsiyon ilave edilebilir.

Options: Easy assembly/disassembly, potentiometer, limit switch box, namur solenoid valve, hand control unit.
Actuator flange connection dimensions: ISO 5211
 Options could be add according to the needs.

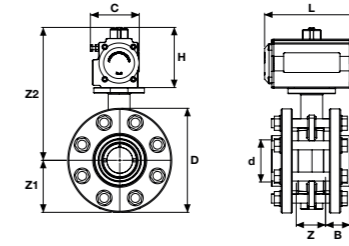
U-PVC Pnömatik Aktüatörlü Kelebek Vana Tek Etkili Takım
 U-PVC Pneumatic Actuator Butterfly Valves Single Effect Without Flange

Su İçin / For Water
Asit İçin / For Acid

Çap Dia	Basınç PN	EPDM Conta Kod EPDM O-Ring Code	Fiyat (Adet) Price (Pcs)	FPM Conta Kod FPM O-Ring Code	Fiyat (Adet) Price (Pcs)	Kg /Adet Kg/Pcs	Koli/Ad. Box/Pcs
63	10	312 00 063 4	320,96 €	312 01 063 4	350,96 €	4,13	1
75	10	312 00 075 4	322,00 €	312 01 075 4	351,46 €	4,73	1
90	10	312 00 090 4	326,74 €	312 01 090 4	362,74 €	7,42	1
110	10	312 00 110 4	364,88 €	312 01 110 4	405,38 €	9,53	1
125	10	312 00 125 4	381,02 €	312 01 125 4	428,52 €	12,43	1
140	10	312 00 140 4	381,02 €	312 01 140 4	428,52 €	13,68	1
160	10	312 00 160 4	610,24 €	312 01 160 4	679,74 €	16,59	1
200	10	312 00 200 4	714,18 €	312 01 200 4	811,68 €	23,19	1
225	10	312 00 225 4	718,18 €	312 01 225 4	817,68 €	23,19	1
250	10	312 00 250 4	1.190,95 €	312 01 250 4	1.443,45 €	47,56	1
280	10	312 00 280 4	1.205,95 €	312 01 280 4	1.465,95 €	50,06	1
315	10	312 00 315 4	1.996,27 €	312 01 315 4	2.571,27 €	58,32	1
355	6	312 00 355 4	Ⓟ	312 01 355 4	Ⓟ		1
400	6	312 00 400 4	Ⓟ	312 01 400 4	Ⓟ		1

Çap Dia	DN (mm)	C (mm)	D (mm)	Z (mm)	Z1 (mm)	B (mm)	L (mm)	H (mm)	nØe (mm)	kv-value l/min.	ISO 5211 ISO 5211
63	50	72	165	51	82	38	147	90	4 x 19	1470	F 07
75	65	72	185	52	92	43	147	90	4 x 19	2200	F 07
90	80	63	200	58	100	51	168	108	8 x 19	3000	F 07
110	100	95	220	66	110	60	184	120	8 x 19	6500	F 07
125	110	95	250	73	125	69	184	120	8 x 23	11500	F 07
140	125	100	250	73	125	75	184	120	8 x 23	11500	F 07
160	150	100	285	76	142	86	204	130	8 x 24	16600	F 07
200	175	108	340	87	170	106	262	140	8 x 24	39600	F 07
225	200	108	340	87	170	120	262	140	8 x 24	39600	F 07
250	250	122	395	123	198	131	268	153	8 x 24	55200	F 10
280	250	122	395	119	198	146	268	153	12 x 24	55200	F 10
315	300	142	445	121	228	164	296	175	12 x 24	80000	F 10
355										90000	
400										115000	

Opsiyonlar: Kolay montaj/demontaj imkanı, pozisyoner, limit anahtar kutusu, namur solenoid vana, el kontrol ünitesi.
Aktüatör flanş bağlantı ölçüleri: ISO 5211.
 İhtiyaca göre opsiyon ilave edilebilir.

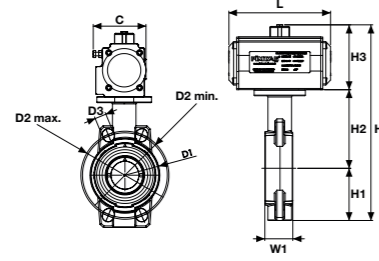
Options: Easy assembly/disassembly, potentiometer, limit switch box, namur solenoid valve, hand control unit.
Actuator flange connection dimensions: ISO 5211
 Options could be add according to the needs.

U-PVC Pnömatik Aktüatörlü Kelebek Vana Tek Etkili Çıplak
 U-PVC Pneumatic Actuator Butterfly Valves Single Effect Without Flange

Onur Bekleniyor
Su İçin / For Water
Asit İçin / For Acid

Çap Dia	Basınç PN	EPDM Conta Kod EPDM O-Ring Code	Fiyat (Adet) Price (Pcs)	FPM Conta Kod FPM O-Ring Code	Fiyat (Adet) Price (Pcs)	Kg /Adet Kg/Pcs	Koli/Ad. Box/Pcs
63	10	310 00 063 4	301,96 €	310 01 063 4	322,46 €	2,25	1
75	10	310 00 075 4	301,96 €	310 01 075 4	322,46 €	2,48	1
90	10	310 00 090 4	302,74 €	310 01 090 4	326,74 €	3,71	1
110	10	310 00 110 4	338,88 €	310 01 110 4	366,38 €	4,20	1
125	10	310 00 125 4	348,02 €	310 01 125 4	379,02 €	7,15	1
140	10	310 00 140 4	348,02 €	310 01 140 4	379,02 €	8,00	1
160	10	310 00 160 4	550,24 €	310 01 160 4	589,74 €	9,98	1
200	10	310 00 200 4	651,18 €	310 01 200 4	717,18 €	13,7	1
225	10	310 00 225 4	651,18 €	310 01 225 4	717,18 €	13,7	1
250	10	310 00 250 4	1.035,95 €	310 01 250 4	1.210,95 €	30,5	1
280	10	310 00 280 4	1.035,95 €	310 01 280 4	1.210,95 €	30,5	1
315	10	310 00 315 4	1.746,27 €	310 01 315 4	2.196,27 €	38,1	1
355	6	310 00 355 4	Ⓜ	310 01 355 4	Ⓜ		1
400	6	310 00 400 4	Ⓜ	310 01 400 4	Ⓜ		1

Çap Dia	DN (mm)	D1 (mm)	D2 min. (mm)	D2 max. (mm)	D3 (mm)	H (mm)	H1 (mm)	H2 (mm)	H3 (mm)	C (mm)	W1 (mm)	L (mm)	kv-value l/min.	ISO 5211 ISO 5211
63	50	54	120	125	19	303	77	134	92	72	45	147	1470	F 07
75	65	57	140	145	19	307	86	129	92	72	46	147	2200	F 07
90	80	131	150	160	19	307	89	132	108	83	48	168	3000	F 07
110	100	160	175	190	19	379	103	156	120	95	56	184	6500	F 07
125	110	190	210	216	23	405	116	169	120	95	63	184	11500	F 07
140	125	190	210	216	23	405	116	169	120	100	63	184	11500	F 07
160	150	214	241	241	24	441	129	182	130	100	66	204	16600	F 07
200	175	268	290	295	24	501	158	203	140	108	75	262	39600	F 07
225	200	268	290	295	24	501	158	203	140	108	75	262	39600	F 07
250	250	333	341	362	24	593	198	242	153	122	114	268	55200	F 10
280	250	333	341	362	24	593	198	242	153	122	114	268	55200	F 10
315	300	379	400	432	25	668	228	285	175	142	113	296	80000	F 10
355													90000	
400													115000	

Opsiyonlar: Kolay montaj/demontaj imkanı, pozisyoner, limit anahtar kutusu, namur solenoid vana, el kontrol ünitesi.
Aktüatör flanş bağlantı ölçüleri: ISO 5211.
 İhtiyaca göre opsiyon ilave edilebilir.

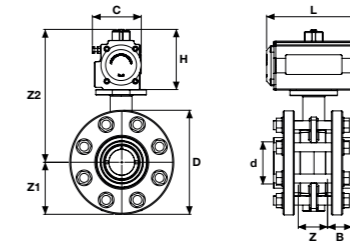
Options: Easy assembly/disassembly, potentiometer, limit switch box, namur solenoid valve, hand control unit.
Actuator flange connection dimensions: ISO 5211
 Options could be add according to the needs.

U-PVC Pnömatik Aktüatörlü Kelebek Vana Tek Etkili 304/316 Paslanmaz Civata-Somun-Pul
 U-PVC Pneumatic Actuator Butterfly Valves Double Effect 304/316 S.S. Screw, Nut,Washer

304 Paslanmaz Civata-Somun-Pul / 304.S.S.Screw,Nut,Washer
316 Paslanmaz Civata-Somun-Pul / 316.S.S.Screw,Nut,Washer
Su İçin / For Water
Asit İçin / For Acid

Çap Dia	EPDM Conta Kod EPDM O-Ring Code	Fiyat (Adet) Price (Pcs)	FPM Conta Kod FPM O-Ring Code	Fiyat (Adet) Price (Pcs)
63	314 00 063 4	344,96 €	314 01 063 4	370,16 €
75	314 00 075 4	345,01 €	314 01 075 4	371,26 €
90	314 00 090 4	355,54 €	314 01 090 4	385,78 €
110	314 00 110 4	397,28 €	314 01 110 4	438,58 €
125	314 00 125 4	419,02 €	314 01 125 4	458,92 €
140	314 00 140 4	419,02 €	314 01 140 4	458,92 €
160	314 00 160 4	668,84 €	314 01 160 4	724,22 €
200	314 00 200 4	792,18 €	314 01 200 4	874,08 €
225	314 00 225 4	797,78 €	314 01 225 4	881,36 €
250	314 00 250 4	1.392,95 €	314 01 250 4	1.605,05 €
280	314 00 280 4	1.413,95 €	314 01 280 4	1.650,55 €
315	314 00 315 4	2.456,27 €	314 01 315 4	2.939,27 €
355	314 00 355 4	Ⓜ	314 01 355 4	Ⓜ
400	314 00 400 4	Ⓜ	314 01 400 4	Ⓜ

Su İçin / For Water
Asit İçin / For Acid

Çap Dia	EPDM Conta Kod EPDM O-Ring Code	Fiyat (Adet) Price (Pcs)	FPM Conta Kod FPM O-Ring Code	Fiyat (Adet) Price (Pcs)
63	316 00 063 4	386,96 €	316 01 063 4	437,36 €
75	316 00 075 4	389,46 €	316 01 075 4	444,06 €
90	316 00 090 4	405,94 €	316 01 090 4	466,42 €
110	316 00 110 4	462,38 €	316 01 110 4	533,78 €
125	316 00 125 4	485,52 €	316 01 125 4	565,32 €
140	316 00 140 4	485,52 €	316 01 140 4	565,32 €
160	316 00 160 4	763,14 €	316 01 160 4	879,90 €
200	316 00 200 4	928,68 €	316 01 200 4	1.092,48 €
225	316 00 225 4	937,08 €	316 01 225 4	1.104,24 €
250	316 00 250 4	1.746,45 €	316 01 250 4	2.170,65 €
280	316 00 280 4	1.777,95 €	316 01 280 4	2.214,75 €
315	316 00 315 4	3.261,27 €	316 01 315 4	4.227,27 €
355	316 00 355 4	Ⓜ	316 01 355 4	Ⓜ
400	316 00 400 4	Ⓜ	316 01 400 4	Ⓜ

Çap Dia	DN (mm)	C (mm)	D (mm)	Z (mm)	Z1 (mm)	B (mm)	L (mm)	H (mm)	nØe (mm)	ISO 5211 ISO 5211	Basınç PN	kv-value l/min.	Q1 (mm)	Q2 (mm)	Kg /Adet Kg/Pcs	Koli/Ad. Box/Pcs
63	50	72	165	51	82	38	147	90	4 x 19	F 07	10	1470	37		4,13	1
75	65	72	185	52	92	43	147	90	4 x 19	F 07	10	2200	50	40	4,73	1
90	80	63	200	58	100	51	168	108	8 x 19	F 07	10	3000	65	46	7,42	1
110	100	95	220	66	110	60	184	120	8 x 19	F 07	10	6500	85	68	9,53	1
125	110	95	250	73	125	69	184	120	8 x 23	F 07	10	11500	111	92	12,43	1
140	125	100	250	73	125	75	184	120	8 x 23	F 07	10	11500	111	92	13,68	1
160	150	100	285	76	142	86	204	130	8 x 24	F 07	10	16600	138	122	16,59	1
200	175	108	340	87	170	106	262	140	8 x 24	F 07	10	39600	192	179	23,19	1
225	200	108	340	87	170	120	262	140	8 x 24	F 07	10	39600	192	179	23,19	1
250	250	122	395	123	198	131	268	153	8 x 24	F 10	10	55200	223	209	47,56	1
280	250	122	395	119	198	146	268	153	12 x 24	F 10	10	55200	223	209	50,06	1
315	300	142	445	121	228	164	296	175	12 x 24	F 10	10	80000	256	253	58,32	1
355											6	90000	325	305		1
400											6	115000	353	350		1

Opsiyonlar: Kolay montaj/demontaj imkanı, pozisyoner, limit anahtar kutusu, namur solenoid vana, el kontrol ünitesi.
Aktüatör flanş bağlantı ölçüleri: ISO 5211.
 İhtiyaca göre opsiyon ilave edilebilir.

Options: Easy assembly/disassembly, potentiometer, limit switch box, namur solenoid valve, hand control unit.
Actuator flange connection dimensions: ISO 5211
 Options could be add according to the needs.

Limit Switch Kutusu
 Limit Switch Box

Kod Code	Fiyat (Adet) Price (Pcs)	Koli/Adet Box/Pcs
201 19 063 9	①	1

Gövde / Body: Alüminyum / Aluminium
Koruma / Protection Class: IP67

Namur Valf (Yön Valf)
 Solenoid Valve

Model	Kod Code	Fiyat (Adet) Price (Pcs)	Koli/Adet Box/Pcs
220VAC 1/4" 5-2	201 18 063 9	①	1
24VDC 1/4" 5-2	201 18 163 9	①	1
12VDC-AC 1/4"5-2	201 18 263 9	①	1

Gövde / Body: Alüminyum / Aluminium
Koruma / Protection Class: IP67
Pozisyon / Positions: 3/2-5/2
Model : Tek ve Çift Bobinli / Single Coil and Double Coils

Rotary Elektro Pnömatik Pozisyoner
 Rotary Elektro Pneumatic Positioner

Kod Code	Fiyat (Adet) Price (Pcs)	Koli/Adet Box/Pcs
201 21 063 9	①	1

Solenoid Valf (Normalde Kapalı)
 Solenoid Valf (Normally Close)

Ölçü Size	Basınç PN	Kod Code	Fiyat (Adet) Price (Pcs)	Model
1/8"	0-16 bar	T00000400	①	GEM 1110
1/4"	0-16 bar	T00000401	①	GEM 1111
3/8"	0.5-16 bar	T00000402	①	GEM 1112
1/2"	0.5-16 bar	T00000403	①	GEM 1113
3/4"	0.5-16 bar	T00000404	①	GEM 1114
1"	0.5-16 bar	T00000405	①	GEM 1115
1 1/4"	0.5-16 bar	T00000406	①	GEM 1116
1 1/2"	0.5-16 bar	T00000407	①	GEM 1117
2"	0.5-16 bar	T00000408	①	GEM 1118

Conta / Gasket : NBR
Kovan / Shell : Paslanmaz / Rustproof
Gövde / Body : Pirinç
Çekirdek / Core : Paslanmaz / Rustproof
Sıcaklık / Heat : -10/+90°C
Bobin / Coil : Soketli / Socket

Solenoid Valf (Normalde Açık)
 Solenoid Valf (Normally Open)

Ölçü Size	Basınç PN	Kod Code	Fiyat (Adet) Price (Pcs)	Model
3/8"	0.5-16 bar	T00000409	①	GEM 1112 A
1/2"	0.5-16 bar	T00000410	①	GEM 1113 A
3/4"	0.5-16 bar	T00000411	①	GEM 1114 A
1"	0.5-16 bar	T00000412	①	GEM 1115 A
1 1/4"	0.5-16 bar	T00000413	①	GEM 1116 A
1 1/2"	0.5-16 bar	T00000414	①	GEM 1117 A
2"	0.5-16 bar	T00000415	①	GEM 1118 A

Conta / Gasket : NBR
Kovan / Shell : Pirinç
Gövde / Body : Pirinç
Çekirdek / Core : Paslanmaz / Rustproof
Sıcaklık / Heat : -10/+90°C
Bobin / Coil : Soketli / Socket



Not / Note

U-PVC

KÜRESEL VANA

BALL VALVE

ÜRETİM STANDARDI

PRODUCTION STANDARD

TS EN ISO 16135

ÇAP / SIZE Ø16 - Ø110



U-PVC Yapıştırma Muflu Küresel Su Vanası

U-PVC Solvent Cement True Union Ball Valve For Water

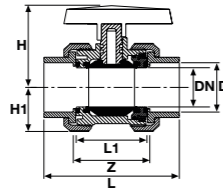

Çap Dia	Basınç PN	EPDM Conta Kod EPDM O-Ring Code	Fiyat (Adet) Price (Pcs)	Kg/Adet Kg/Pcs	Koli/Adet Box/Pcs	DN (mm)	kv l/min	Z (mm)	L1 (mm)	L (mm)	H (mm)	H1 (mm)
16	16	202 00 016 2	6,30 €	1	55	12	70	50	42	80	47	27
20	16	202 00 020 2	5,20 €	0,14	55	15	185	52	45	85	47	27
25	16	202 00 025 2	5,50 €	0,18	75	20	350	58	49	95	51	31
32	16	202 00 032 2	6,50 €	0,25	60	25	700	61	54	107	63	33
40	16	202 00 040 2	7,00 €	0,43	30	32	1000	73	66	128	67	41
50	16	202 00 050 2	8,20 €	0,65	20	40	1600	82	75	154	86	46
63	16	202 00 063 2	10,80 €	1,13	12	50	3100	95	89	172	101	58
75	16	202 00 075 2	28,00 €	1,47	5	65	5000	118	111	196	110	73
90	16	202 00 090 2	37,00 €	3,58	4	80	7000	139	126	241	137	89
110	16	202 00 110 2	55,00 €	5,43	2	100	11000	165	153	289	150	105

U-PVC Küresel Su Vanası Tek Taraf İçten Dışlı

U-PVC One Side Female Threaded True Union Ball Valve For Water

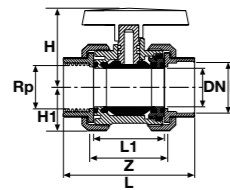

Çap Dia	Rp (Inch)	Basınç PN	EPDM Conta Kod EPDM O-Ring Code	Fiyat (Adet) Price (Pcs)	Kg/Adet Kg/Pcs	Koli/Adet Box/Pcs	DN (mm)	kv l/min	Z (mm)	L1 (mm)	L (mm)	H (mm)	H1 (mm)
16	3/8"	16	203 00 016 2	7,20 €	0	55	12	70	50	42	80	47	27
20	1/2"	16	203 00 020 2	6,10 €	0,14	55	15	185	52	45	85	47	27
25	3/4"	16	203 00 025 2	6,50 €	0,19	75	20	350	58	49	95	51	31
32	1"	16	203 00 032 2	7,80 €	0,24	60	25	700	61	54	107	63	33
40	1 1/4"	16	203 00 040 2	8,30 €	0,42	30	32	1000	73	66	128	67	41
50	1 1/2"	16	203 00 050 2	9,50 €	0,66	20	40	1600	82	75	154	86	46
63	2"	16	203 00 063 2	12,10 €	1,17	12	50	3100	95	89	172	101	58
75	2 1/2"	16	203 00 075 2	30,00 €	1,48	9	65	5000	118	111	196	110	73
90	3"	16	203 00 090 2	39,00 €	3,56	4	80	7000	139	126	241	137	89
110	4"	16	203 00 110 2	58,00 €	5,35	2	100	11000	165	153	289	150	105

U-PVC Küresel Su Vanası Çift Taraf İçten Dışlı

U-PVC Both Sides Female Threaded True Union Ball Valve For Water

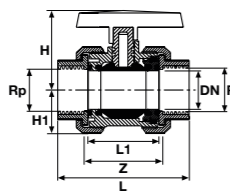

Çap Dia	Rp (Inch)	Basınç PN	EPDM Conta Kod EPDM O-Ring Code	Fiyat (Adet) Price (Pcs)	Kg/Adet Kg/Pcs	Koli/Adet Box/Pcs	DN (mm)	kv l/min	Z (mm)	L1 (mm)	L (mm)	H (mm)	H1 (mm)
16	3/8"	16	204 00 016 2	8,10 €	0,19	55	12	70	50	42	80	47	27
20	1/2"	16	204 00 020 2	7,00 €	0,14	55	15	185	52	45	85	47	27
25	3/4"	16	204 00 025 2	7,40 €	0,19	75	20	350	58	49	95	51	31
32	1"	16	204 00 032 2	8,90 €	0,24	60	25	700	61	54	107	63	33
40	1 1/4"	16	204 00 040 2	9,40 €	0,42	30	32	1000	73	66	128	67	41
50	1 1/2"	16	204 00 050 2	10,80 €	0,66	20	40	1600	82	75	154	86	46
63	2"	16	204 00 063 2	13,40 €	1,17	12	50	3100	95	89	172	101	58
75	2 1/2"	16	204 00 075 2	32,00 €	1,48	9	65	5000	118	111	196	110	73
90	3"	16	204 00 090 2	41,00 €	3,56	4	80	7000	139	126	241	137	89
110	4"	16	204 00 110 2	61,00 €	5,35	2	100	11000	165	153	289	150	105

U-PVC Küresel Su Vanası Çift Taraf Flanş Bağlantılı

U-PVC Both Sides Female Threaded Ball Valve For Water

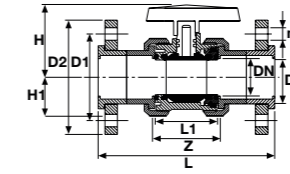

Çap Dia	Basınç PN	EPDM Conta Kod EPDM O-Ring Code	Fiyat (Adet) Price (Pcs)	Kg/Adet Kg/Pcs	Koli/Adet Box/Pcs	DN (mm)	kv l/min	Z (mm)	L1 (mm)	L (mm)	H (mm)	H1 (mm)	D1 (mm)	D2 (mm)	n (mmxAdet)
20	16	208 00 020 2	16,30 €	0,36	40	15	185	52	45	123	47	27	65	95	14 x 4
25	16	208 00 025 2	17,40 €	0,47	30	20	350	58	49	140	51	31	75	105	14 x 4
32	16	208 00 032 2	18,35 €	0,66	25	25	700	61	54	158	63	33	85	115	14 x 4
40	16	208 00 040 2	19,50 €	1,08	20	32	1000	73	66	186	67	42	100	140	18 x 4
50	16	208 00 050 2	24,00 €	1,44	10	40	1600	82	75	231	86	46	110	150	18 x 4
63	16	208 00 063 2	26,50 €	2,29	10	50	3100	95	89	253	101	58	125	165	18 x 4
75	16	208 00 075 2	52,00 €	2,99	4	65	5000	118	111	291	110	73	145	185	18 x 4
90	16	208 00 090 2	62,50 €	5,7	2	80	7000	139	126	353	137	90	160	200	18 x 8
110	16	208 00 110 2	104,70 €	8,05	1	100	11000	165	153	431	150	106	180	220	18 x 8

U-PVC Üç Yollu Küresel Vana (T Port)

U-PVC Three Ways Ball Valve (T Port)

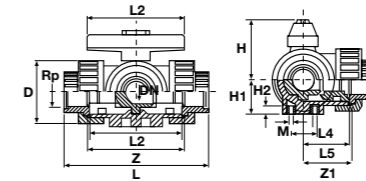

Çap Dia	Basınç PN	Kod Code	Fiyat (Adet) Price (Pcs)	Kg/Adet Kg/Pcs	Koli/Adet Box/Pcs	D (mm)	L (mm)	L1 (mm)	L2 (mm)	L3 (mm)	L4 (mm)	L5 (mm)	L6 (mm)	L7 (mm)	H (mm)
20	10	210 01 020 4	133,53 €	0,25	55	45	134	78	72	139	25	36	67	70	50
25	10	210 01 025 4	146,88 €	0,36	75	53	156	92	86	161	25	43	78	81	60
32	10	210 01 032 4	151,88 €	0,54	60	65	172	100	96	177	25	48	86	89	68
40	10	210 01 040 4	156,88 €	0,93	30	78	202	110	116	207	45	58	101	104	79
50	10	210 01 050 4	253,73 €	1,36	20	92	238	120	137	242	45	69	119	121	90
63	10	210 01 063 4	258,73 €	2,66	12	116	290	146	179	294	45	90	145	147	109

U-PVC Üç Yollu Üç Tarafı İçten Dışlı Küresel Vana (T Port)

U-PVC Three Ways Female Threaded Ball Valve (T Port)

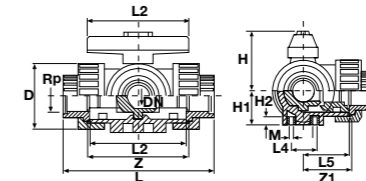

Çap Dia	Basınç PN	Kod Code	Fiyat (Adet) Price (Pcs)	Kg/Adet Kg/Pcs	Koli/Adet Box/Pcs	D (mm)	L (mm)	L1 (mm)	L2 (mm)	L4 (mm)	L5 (mm)	H (mm)	H1 (mm)
20	10	211 00 020 4	160,24 €	0,25	55	45	111	78	72	25	36	50	27
25	10	211 00 025 4	176,26 €	0,36	75	53	131	92	86	25	43	60	33
32	10	211 00 032 4	182,26 €	0,54	60	65	148	100	96	25	48	68	36
40	10	211 00 040 4	188,26 €	0,93	30	78	176	110	116	45	58	79	44
50	10	211 00 050 4	304,48 €	1,4	20	92	206	120	137	45	69	90	49
63	10	211 00 063 4	310,48 €	2,66	12	116	262	146	179	45	90	109	61

U-PVC Yapıştırma Mufllu Küresel Su Vanası (Pozisyon Ayarlı)
U-PVC Solvent Cement True Union Ball Valve Position Regulated For Water

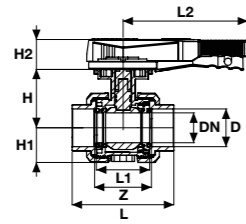

Çap Dia	Basınç PN	EPDM Conta Kod EPDM O-Ring Code	Fiyat (Adet) Price (Pcs)	Kg/Adet Kg/Pcs	Koli/Adet Box/Pcs	DN (mm)	Z (mm)	L1 (mm)	L2 (mm)	L (mm)	H (mm)	H1 (mm)	H2 (mm)	kv l/min
63	16	202 10 063 2	16,20 €	1,16	12	50	95	89	207,5	172	101	58	48	3100
75	16	202 10 075 2	42,00 €	1,45	9	65	118	111	207,5	196	110	73	50	5000
90	16	202 10 090 2	55,50 €	3,51	2	80	139	126	207,5	241	137	89	52	7000
110	16	202 10 110 2	82,50 €	5,40	2	100	165	153	259,5	289	150	105	52	11000

U-PVC Küresel Su Vanası Çift Taraf Flanş Bağlantılı (Pozisyon Ayarlı)
U-PVC Solvent Cement Both Sides Flanged True Union Ball Valve Position Regulated For Water

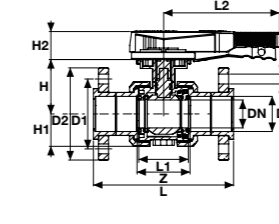

Çap Dia	Basınç PN	EPDM Conta Kod EPDM O-Ring Code	Fiyat (Adet) Price (Pcs)	Kg/Adet Kg/Pcs	Koli/Adet Box/Pcs	DN (mm)	Z (mm)	L1 (mm)	L2 (mm)	L (mm)	H (mm)	H1 (mm)	H2 (mm)	D1 (mm)	D2 (mm)	n (mm)	kv l/min
63	16	208 10 063 2	39,75 €	0,36	12	50	95	89	207,5	253	101	58	48	125	165	18x4	3100
75	16	208 10 075 2	78,00 €	0,47	9	65	118	111	207,5	291	110	64	50	145	185	22x4	5000
90	16	208 10 090 2	93,75 €	0,66	4	80	139	126	207,5	353	137	90	52	160	200	22x8	7000
110	16	208 10 110 2	157,05 €	1,08	2	100	165	153	259,5	431	150	106	52	180	220	24x8	11000

U-PVC Yapıştırma Mufllu Küresel Su Vanası Tek Taraf İçten Dişli (Pozisyon Ayarlı)
U-PVC True Union Ball Valves Position Regulated For Water One Side Female Threaded

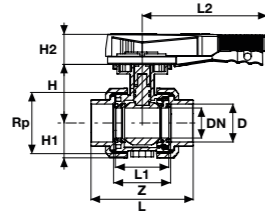

Çap Dia	Rp (Inch)	Basınç PN	EPDM Conta Kod EPDM O-Ring Code	Fiyat (Adet) Price (Pcs)	Kg/Adet Kg/Pcs	Koli/Adet Box/Pcs	DN (mm)	Z (mm)	L1 (mm)	L2 (mm)	L (mm)	H (mm)	H1 (mm)	H2 (mm)	kv l/min
63	2"	16	203 10 063 2	18,15 €	1,16	12	50	95	89	207,5	172	101	58	48	3100
75	2 1/2"	16	203 10 075 2	45,00 €	1,45	9	65	118	111	207,5	196	110	73	50	5000
90	3"	16	203 10 090 2	58,50 €	3,51	4	80	139	126	207,5	241	137	89	52	7000
110	4"	16	203 10 110 2	87,00 €	5,40	2	100	165	153	259,5	289	150	105	52	11000

U-PVC Küresel Su Vanası Çift Taraf İçten Dişli (Pozisyon Ayarlı)
U-PVC True Union Ball Valves Position Regulated For Water One Side Female Threaded

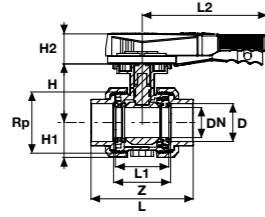

Çap Dia	Rp (Inch)	Basınç PN	EPDM Conta Kod EPDM O-Ring Code	Fiyat (Adet) Price (Pcs)	Kg/Adet Kg/Pcs	Koli/Adet Box/Pcs	DN (mm)	Z (mm)	L1 (mm)	L2 (mm)	L (mm)	H (mm)	H1 (mm)	H2 (mm)	kv l/min
63	2"	16	204 10 063 2	20,10 €	1,16	12	50	95	89	207,5	172	101	58	48	3100
75	2 1/2"	16	204 10 075 2	48,00 €	1,45	9	65	118	111	207,5	196	110	73	50	5000
90	3"	16	204 10 090 2	61,50 €	3,51	4	80	139	126	207,5	241	137	89	52	7000
110	4"	16	204 10 110 2	91,50 €	5,40	2	100	165	153	259,5	289	150	105	52	11000



U-PVC Yapıştırma Muflu Küresel Su Vanası (Tek Tarafı Piriç İç Diş)

U-PVC One Side Brass Female Threaded Solvent Cement True Union Ball Valve For Water

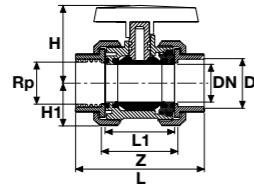

Çap Dia	Rp (Inch)	Basınç PN	Kod Code	Fiyat (Adet) Price (Pcs)	Kg/Adet Kg/Pcs	Koli/Adet Box/Pcs	DN (mm)	kv l/min	Z (mm)	L1 (mm)	L (mm)	H (mm)	H1 (mm)
20	1/2"	16	243 00 020 2	12,74 €	0,18	55	15	185	52	45	86	47	27
25	3/4"	16	243 00 025 2	15,92 €	0,24	75	20	350	58	49	96	51	31
32	1"	16	243 00 032 2	19,02 €	0,31	60	25	700	61	54	106	63	33
40	1 1/4"	16	243 00 040 2	28,98 €	0,50	30	32	1000	73	66	127	67	42
50	1 1/2"	16	243 00 050 2	42,87 €	0,80	20	40	1600	82	75	153	86	46
63	2"	16	243 00 063 2	61,13 €	1,36	12	50	3100	95	89	172	101	58

U-PVC Küresel Su Vanası (Tek Tarafı Piriç Dış Diş)

U-PVC One Side Brass Male Threaded Solvent Cement True Union Ball Valve For Water

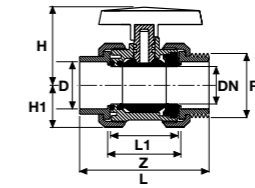

Çap Dia	Rp (Inch)	Basınç PN	Kod Code	Fiyat (Adet) Price (Pcs)	Kg/Adet Kg/Pcs	Koli/Adet Box/Pcs	DN (mm)	kv l/min	Z (mm)	L1 (mm)	L (mm)	H (mm)	H1 (mm)
20	1/2"	16	243 20 020 2	13,61 €	0,19	55	15	185	52	45	112	47	27
25	3/4"	16	243 20 025 2	17,03 €	0,26	75	20	350	58	49	113	51	31
32	1"	16	243 20 032 2	20,97 €	0,34	60	25	700	61	54	136	63	33
40	1 1/4"	16	243 20 040 2	33,45 €	0,57	30	32	1000	73	66	158	67	42
50	1 1/2"	16	243 20 050 2	48,23 €	0,86	20	40	1600	82	75	173	86	46
63	2"	16	243 20 063 2	69,54 €	1,45	12	50	3100	95	89	203	101	58

U-PVC İç Dişli Küresel Su Vanası (Tek Tarafı Piriç İç Diş)

U-PVC One Side Brass Female Threaded Other Side Female Threaded True Union Ball Valve For Water

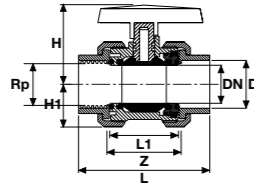

Çap Dia	Rp (Inch)	Basınç PN	Kod Code	Fiyat (Adet) Price (Pcs)	Kg/Adet Kg/Pcs	Koli/Adet Box/Pcs	DN (mm)	kv l/min	Z (mm)	L1 (mm)	L (mm)	H (mm)	H1 (mm)
20	1/2"	16	244 00 020 2	14,09 €	0,20	55	15	185	52	45	86	47	27
25	3/4"	16	244 00 025 2	17,42 €	0,35	75	20	350	58	49	96	51	31
32	1"	16	244 00 032 2	20,97 €	0,31	60	25	700	61	54	106	63	33
40	1 1/4"	16	244 00 040 2	30,93 €		30	32	1000	73	66	127	67	42
50	1 1/2"	16	244 00 050 2	44,82 €		20	40	1600	82	75	153	86	46
63	2"	16	244 00 063 2	63,08 €	1,53	12	50	3100	95	89	172	101	58

U-PVC İç Diş Küresel Su Vanası (Tek Taraf Piriç Dış Diş)

U-PVC One Side Female Threaded Other Side Brass Male Threaded True Union Ball Valve For Water

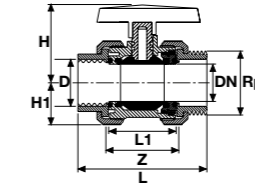

Çap Dia	Rp (Inch)	Basınç PN	Kod Code	Fiyat (Adet) Price (Pcs)	Kg/Adet Kg/Pcs	Koli/Adet Box/Pcs	DN (mm)	kv l/min	Z (mm)	L1 (mm)	L (mm)	H (mm)	H1 (mm)
20	1/2"	16	244 20 020 2	14,96 €	0,19	55	15	185	52	45	112	47	27
25	3/4"	16	244 20 025 2	18,53 €	0,26	75	20	350	58	49	113	51	31
32	1"	16	244 20 032 2	22,92 €	0,34	60	25	700	61	54	136	63	33
40	1 1/4"	16	244 20 040 2	35,40 €	0,57	30	32	1000	73	66	158	67	42
50	1 1/2"	16	244 20 050 2	50,18 €	0,87	20	40	1600	82	75	173	86	46
63	2"	16	244 20 063 2	71,49 €	1,48	12	50	3100	95	89	203	101	58

U-PVC Küresel Su Vanası (Çift Tarafı Piriç İç Diş)

U-PVC Both Sides Brass Female Threaded True Union Ball Valve For Water

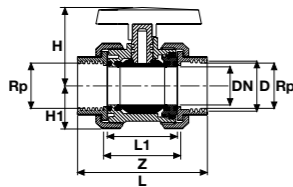

Çap Dia	Rp (Inch)	Basınç PN	Kod Code	Fiyat (Adet) Price (Pcs)	Kg/Adet Kg/Pcs	Koli/Adet Box/Pcs	DN (mm)	kv l/min	Z (mm)	L1 (mm)	L (mm)	H (mm)	H1 (mm)
20	1/2"	16	244 10 020 2	15,48 €	0,20	55	15	185	52	45	86	47	27
25	3/4"	16	244 10 025 2	19,16 €	0,35	75	20	350	58	49	96	51	31
32	1"	16	244 10 032 2	23,06 €	0,31	60	25	700	61	54	106	63	33
40	1 1/4"	16	244 10 040 2	34,02 €		30	32	1000	73	66	127	67	42
50	1 1/2"	16	244 10 050 2	49,29 €	1	20	40	1600	82	75	153	86	46
63	2"	16	244 10 063 2	69,38 €	1,53	12	50	3100	95	89	172	101	58

U-PVC Küresel Su Vanası (Tek Tarafı İç Diş Tek Tarafı Piriç Dış Diş)

U-PVC One Side Brass Female Threaded One Side Brass Male Threaded True Union Ball Valve For Water

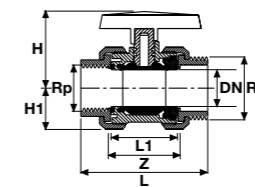

Çap Dia	Rp (Inch)	Basınç PN	Kod Code	Fiyat (Adet) Price (Pcs)	Kg/Adet Kg/Pcs	Koli/Adet Box/Pcs	DN (mm)	kv l/min	Z (mm)	L1 (mm)	L (mm)	H (mm)	H1 (mm)
20	1/2"	16	245 20 020 2	21,00 €	0,21	55	15	185	52	45	112	47	27
25	3/4"	16	245 20 025 2	25,50 €	0,36	75	20	350	58	49	113	51	31
32	1"	16	245 20 032 2	30,00 €	0,33	60	25	700	61	54	136	63	33
40	1 1/4"	16	245 20 040 2	42,00 €	0,66	30	32	1000	73	66	158	67	42
50	1 1/2"	16	245 20 050 2	64,20 €	0,96	20	40	1600	82	75	173	86	46
63	2"	16	245 20 063 2	88,50 €	1,62	12	50	3100	95	89	203	101	58

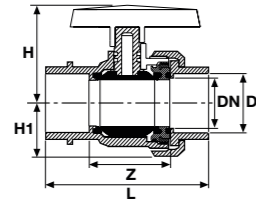
U-PVC Tek Taraflı Küresel Vana Çift Taraflı Yapıştırma
 U-PVC Solvent Cement Single Union Ball Valve

Çap Dia	Basınç PN	EPDM Conta Kod EPDM O-Ring Code	Fiyat (Adet) Price (Pcs)	Kg/Adet Kg/Pcs	Koli/Adet Box/Pcs	DN (mm)	Z (mm)	L (mm)	H (mm)	H1 (mm)
20	16	232 00 020 2	4,42 €	0,10	55	15	52	78	47	27
25	16	232 00 025 2	4,68 €	0,13	56	20	58	87	52	31
32	16	232 00 032 2	5,53 €	0,19	60	25	61	100	63	33
40	16	232 00 040 2	5,95 €	0,30	40	32	73	114	66	42
50	16	232 00 050 2	6,97 €	0,51	20	40	82	146	89	41
63	16	232 00 063 2	9,18 €	0,90	12	50	95	160	100	58
75	16	232 00 075 2	23,80 €	1,19	9	65	118	195	110	65
90	16	232 00 090 2	31,45 €	2,78	4	80	139	228	137	89
110	16	232 00 110 2	46,75 €	4,47	2	100	165	275	150	105

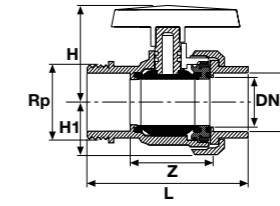
U-PVC Y.M. Küresel Tek Taraflı Vana Tek Taraf Dıştan Dişli
 U-PVC Solvent Cement Single Union Ball Valve One Side Male Threaded

Çap Dia	Rp (Inch)	Basınç PN	EPDM Conta Kod EPDM O-Ring Code	Fiyat (Adet) Price (Pcs)	Kg/Adet Kg/Pcs	Koli/Adet Box/Pcs	DN (mm)	Z (mm)	L (mm)	H (mm)	H1 (mm)
20	1/2"	16	232 60 020 2	5,30 €	0,11	55	15	50	82	47	27
25	3/4"	16	232 60 025 2	5,65 €	0,14	50	20	52	92	52	31
32	1"	16	232 60 032 2	6,78 €	0,19	60	25	58	105	63	33
40	1 1/4"	16	232 60 040 2	7,22 €	0,31	40	32	73	125	66	42
50	1 1/2"	16	232 60 050 2	8,26 €	0,52	20	40	82	146	89	41
63	2"	16	232 60 063 2	10,52 €	0,90	12	50	95	160	100	58
75	2 1/2"	16	232 60 075 2	26,09 €		9	65	118	195	110	65
90	3"	16	232 60 090 2	33,91 €		4	80	139	228	137	89
110	4"	16	232 60 110 2	50,43 €		2	100	165	275	150	105

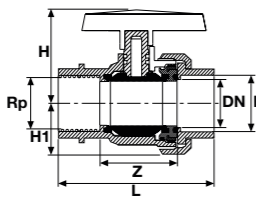
U-PVC Y.M. Küresel Tek Taraflı Vana Tek Taraf İçten Dişli
 U-PVC Solvent Cement Single Union Ball Valve One Side Female Threaded

Çap Dia	Rp (Inch)	Basınç PN	EPDM Conta Kod EPDM O-Ring Code	Fiyat (Adet) Price (Pcs)	Kg/Adet Kg/Pcs	Koli/Adet Box/Pcs	DN (mm)	Z (mm)	L (mm)	H (mm)	H1 (mm)
20	1/2"	16	232 20 020 2	5,30 €	0,10	55	15	52	78	47	27
25	3/4"	16	232 20 025 2	5,65 €	0,14	56	20	58	87	52	31
32	1"	16	232 20 032 2	6,78 €	0,19	60	25	61	100	63	33
40	1 1/4"	16	232 20 040 2	7,22 €	0,31	30	32	73	114	66	42
50	1 1/2"	16	232 20 050 2	8,26 €	0,50	20	40	82	146	89	41
63	2"	16	232 20 063 2	10,52 €	0,91	12	50	95	160	100	58
75	2 1/2"	16	232 20 075 2	26,09 €	1,12	9	65	118	195	110	65
90	3"	16	232 20 090 2	33,91 €	2,82	4	80	139	228	137	89
110	4"	16	232 20 110 2	50,43 €	4,30	2	100	165	275	150	105

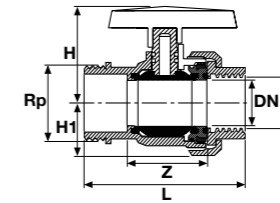
U-PVC Küresel Tek Taraflı Vana Tek Taraf İçten Dişli Tek Taraf Dış Dişli
 U-PVC One Side Female Threaded Other Side Male Threaded Single Union Ball Valve

Çap Dia	Rp (Inch)	Basınç PN	EPDM Conta Kod EPDM O-Ring Code	Fiyat (Adet) Price (Pcs)	Kg/Adet Kg/Pcs	Koli/Adet Box/Pcs	DN (mm)	Z (mm)	L (mm)	H (mm)	H1 (mm)
20	1/2"	16	232 80 020 2	6,09 €	0,10	55	15	50	85	47	27
25	3/4"	16	232 80 025 2	6,43 €	0,14	56	20	52	92	52	31
32	1"	16	232 80 032 2	7,74 €	0,19	60	25	58	107	63	33
40	1 1/4"	16	232 80 040 2	8,17 €	0,31	30	32	73	114	66	42
50	1 1/2"	16	232 80 050 2	9,39 €	0,52	20	40	82	140	89	41
63	2"	16	232 80 063 2	11,65 €	0,92	12	50	95	163	100	58
75	2 1/2"	16	232 80 075 2	27,83 €		9	65	118	195	110	65
90	3"	16	232 80 090 2	35,65 €		4	80	139	228	137	89
110	4"	16	232 80 110 2	53,04 €		2	100	165	275	150	105

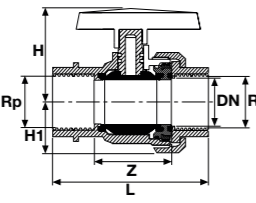
U-PVC Y.M. Küresel Tek Taraflı Vana Çift Taraf İçten Dişli
 U-PVC Solvent Cement Single Union Ball Valve Both Sides Female Threaded

Rp (Inch)	Basınç PN	EPDM Conta Kod EPDM O-Ring Code	Fiyat (Adet) Price (Pcs)	Kg/Adet Kg/Pcs	Koli/Adet Box/Pcs	DN (mm)	Z (mm)	L (mm)	H (mm)	H1 (mm)
1/2"	16	232 40 020 2	6,09 €	0,10	55	15	52	78	47	27
3/4"	16	232 40 025 2	6,43 €	0,14	50	20	58	87	52	31
1"	16	232 40 032 2	7,74 €	0,19	60	25	61	100	63	33
1 1/4"	16	232 40 040 2	8,17 €	0,30	30	32	73	114	66	42
1 1/2"	16	232 40 050 2	9,39 €	0,51	20	40	82	146	89	41
2"	16	232 40 063 2	11,65 €	0,91	12	50	95	160	100	58
2 1/2"	16	232 40 075 2	27,83 €	1,22	9	65	118	195	110	65
3"	16	232 40 090 2	35,65 €	2,82	4	80	139	228	137	89
4"	16	232 40 110 2	53,04 €	4,37	2	100	165	275	150	105

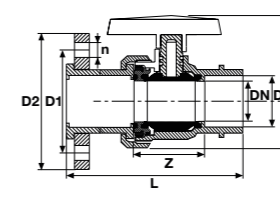
U-PVC Yapıştırma Mufllu Küresel Tek Taraflı Vana Tek Taraf Flanş Çıkışlı
 U-PVC Solvent Cement Single Union Ball Valve One Side Flange Outlet

Çap Dia	Basınç PN	EPDM Conta Kod EPDM O-Ring Code	Fiyat (Adet) Price (Pcs)	Kg/Adet Kg/Pcs	Koli/Adet Box/Pcs	DN (mm)	Z (mm)	L (mm)	H (mm)	H1 (mm)	D1 (mm)	D2 (mm)	n (mm)	kv l/min
20	16	232 10 020 2	6,13 €		55	15	52	101	47	27	65	96	14x4	185
25	16	232 10 025 2	6,41 €		56	20	58	114	51	31	75	105	14x4	350
32	16	232 10 032 2	7,51 €		60	25	61	129	63	33	85	115	14x4	700
40	16	232 10 040 2	8,20 €		30	32	73	150	67	42	100	140	14x4	1000
50	16	232 10 050 2	9,32 €		24	40	82	188	86	46	100	150	18x4	1600
63	16	232 10 063 2	9,48 €		12	50	95	206	101	58	125	165	18x4	3100
75	16	232 10 075 2	28,55 €		9	65	118	242	110	64	145	185	22x4	5000
90	16	232 10 090 2	37,24 €		4	80	139	290	137	90	160	200	22x8	7000
110	16	232 10 110 2	54,23 €		2	100	165	353	150	106	180	220	24x8	11000

U-PVC Y.M. Küresel Asit Vanası

U-PVC Solvent Cement True Union Ball Valve For Acid

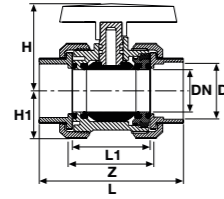

Düşük Dayanımlı Asit İçin
For Low Strength Acid

Yüksek Dayanımlı Asit İçin
For High Strength Acid

Çap Dia	Basınç PN	Kod / Code EPDM & PTFE O-Ring	Fiyat (Adet) Price (Pcs)	Kod / Code FPM & PTFE O-Ring	Fiyat (Adet) Price (Pcs)	Kg/Adet Kg/Pcs	Koli/Adet Box/Pcs	DN (mm)	Z (mm)	L1 (mm)	L (mm)	H (mm)	H1 (mm)	kv l/min
20	16	205 00 020 2	7,40 €	234 00 020 2	12,46 €	0,14	55	15	52	45	85	47	27	185
25	16	205 00 025 2	9,40 €	234 00 025 2	16,78 €	0,19	75	20	58	49	95	51	31	350
32	16	205 00 032 2	12,60 €	234 00 032 2	19,98 €	0,25	60	25	61	54	107	63	33	700
40	16	205 00 040 2	15,60 €	234 00 040 2	25,89 €	0,43	30	32	73	66	128	67	41	1000
50	16	205 00 050 2	18,20 €	234 00 050 2	32,29 €	0,66	24	40	82	75	154	86	46	1600
63	16	205 00 063 2	22,00 €	234 00 063 2	40,94 €	1,11	12	50	95	89	172	101	58	3100
75	16	205 00 075 2	52,00 €	234 00 075 2	92,45 €	1,48	6	65	118	111	196	110	73	5000
90	16	205 00 090 2	67,00 €	234 00 090 2	92,76 €	3,55	4	80	139	126	241	137	89	7000
110	16	205 00 110 2	86,00 €	234 00 110 2	130,50 €	5,48	2	100	165	153	289	150	105	11000

U-PVC Küresel Asit Vanası (Çift Taraf İçten Dişli)

U-PVC Both Sides Female Threaded True Union Ball Valve For Acid

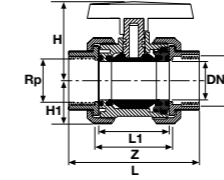

Düşük Dayanımlı Asit İçin
For Low Strength Acid

Yüksek Dayanımlı Asit İçin
For High Strength Acid

Rp (Inch)	Basınç PN	Kod / Code EPDM & PTFE O-Ring	Fiyat (Adet) Price (Pcs)	Kod / Code FPM & PTFE O-Ring	Fiyat (Adet) Price (Pcs)	Kg/Adet Kg/Pcs	Koli/Adet Box/Pcs	DN (mm)	Z (mm)	L1 (mm)	L (mm)	H (mm)	H1 (mm)	kv l/min
1/2"	16	207 00 020 2	9,20 €	236 00 020 2	14,26 €	0,14	55	15	52	45	85	47	27	185
3/4"	16	207 00 025 2	11,20 €	236 00 025 2	18,58 €	0,19	75	20	58	49	95	51	31	350
1"	16	207 00 032 2	14,20 €	236 00 032 2	21,58 €	0,24	60	25	61	54	107	63	33	700
1 1/4"	16	207 00 040 2	17,20 €	236 00 040 2	27,49 €	0,42	30	32	73	66	128	67	41	1000
1 1/2"	16	207 00 050 2	20,80 €	236 00 050 2	34,89 €	0,67	24	40	82	75	154	86	46	1600
2"	16	207 00 063 2	24,60 €	236 00 063 2	43,54 €	1,21	12	50	95	89	172	101	58	3100
2 1/2"	16	207 00 075 2	56,00 €	236 00 075 2	96,45 €	1,53	6	65	118	111	196	110	73	5000
3"	16	207 00 090 2	71,00 €	236 00 090 2	96,76 €	3,61	4	80	139	126	241	137	89	7000
4"	16	207 00 110 2	93,00 €	236 00 110 2	137,50 €	5,30	2	100	165	153	289	150	105	11000

U-PVC Küresel Asit Vanası (Tek Taraf İçten Dişli)

U-PVC One Side Female Threaded True Union Ball Valves For Acid

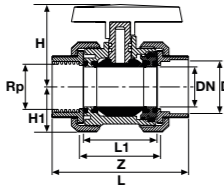

Düşük Dayanımlı Asit İçin
For Low Strength Acid

Yüksek Dayanımlı Asit İçin
For High Strength Acid

Çap Dia	Rp (Inch)	Basınç PN	Kod / Code EPDM & PTFE O-Ring	Fiyat (Adet) Price (Pcs)	Kod / Code FPM & PTFE O-Ring	Fiyat (Adet) Price (Pcs)	Kg/Adet Kg/Pcs	Koli/Adet Box/Pcs	DN (mm)	kv l/min	Z (mm)	L1 (mm)	L (mm)	H (mm)	H1 (mm)
20	1/2"	16	206 00 020 2	8,30 €	235 00 020 2	13,36 €	0,14	55	15	185	52	45	85	47	27
25	3/4"	16	206 00 025 2	10,40 €	235 00 025 2	17,78 €	0,19	75	20	350	58	49	95	51	31
32	1"	16	206 00 032 2	13,90 €	235 00 032 2	21,28 €	0,24	60	25	700	61	54	107	63	33
40	1 1/4"	16	206 00 040 2	16,90 €	235 00 040 2	27,19 €	0,42	30	32	1000	73	66	128	67	41
50	1 1/2"	16	206 00 050 2	19,50 €	235 00 050 2	33,59 €	0,66	24	40	1600	82	75	154	86	46
63	2"	16	206 00 063 2	23,30 €	235 00 063 2	42,24 €	1,19	12	50	3100	95	89	172	101	58
75	2 1/2"	16	206 00 075 2	54,00 €	235 00 075 2	94,45 €	1,51	6	65	5000	118	111	196	110	73
90	3"	16	206 00 090 2	69,00 €	235 00 090 2	94,76 €	3,57	4	80	7000	139	126	241	137	89
110	4"	16	206 00 110 2	89,00 €	235 00 110 2	133,50 €	5,36	2	100	11000	165	153	289	150	105

U-PVC Küresel Asit Vanası (Çift Taraf Flanş Bağlantılı)

U-PVC Both Sides Female Threaded Ball Valves For Acid

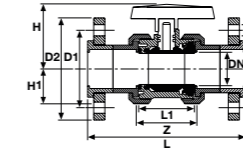

Düşük Dayanımlı Asit İçin
For Low Strength Acid

Yüksek Dayanımlı Asit İçin
For High Strength Acid

Çap Dia	Basınç PN	Kod / Code EPDM PTFE O-Ring	Fiyat (Adet) Price (Pcs)	Kod / Code FPM & PTFE O-Ring	Fiyat (Adet) Price (Pcs)	Kg/Adet Kg/Pcs	Koli/Adet Box/Pcs	DN (mm)	Z (mm)	L1 (mm)	L (mm)	H (mm)	H1 (mm)	D1 (mm)	D2 (mm)	n (mmxAdet)
20	16	209 00 020 2	19,50 €	237 00 020 2	24,56 €	0,35	55	15	52	45	123	47	27	65	95	14 x 4
25	16	209 00 025 2	21,50 €	237 00 025 2	28,88 €	0,52	75	20	58	49	140	51	31	75	105	14 x 4
32	16	209 00 032 2	25,00 €	237 00 032 2	32,38 €	0,60	60	25	61	54	158	63	33	85	115	14 x 4
40	16	209 00 040 2	30,00 €	237 00 040 2	40,29 €	1,02	30	32	73	66	186	67	42	100	140	18 x 4
50	16	209 00 050 2	33,00 €	237 00 050 2	47,09 €	1,25	24	40	82	75	231	86	46	110	150	18 x 4
63	16	209 00 063 2	38,00 €	237 00 063 2	56,94 €	1,99	12	50	95	89	253	101	58	125	165	18 x 4
75	16	209 00 075 2	80,00 €	237 00 075 2	120,50 €	2,65	10	65	118	111	291	110	73	145	185	18 x 4
90	16	209 00 090 2	90,00 €	237 00 090 2	125,80 €	5,13	4	80	139	126	353	137	90	160	200	18 x 8
110	16	209 00 110 2	155,00 €	237 00 110 2	199,50 €	7,05	2	100	165	153	431	150	106	180	220	18 x 8

U-PVC Üç Yollu Küresel Asit Vanası (T Port)
U-PVC Three Ways Ball Valve (T Port)

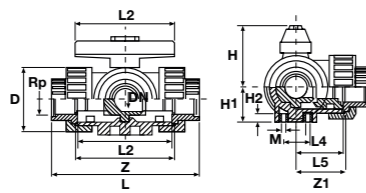

Çap Dia	Basınç PN	Kod Code	Fiyat (Adet) Price (Pcs)	Kg/Adet Kg/Pcs	Koli/Adet Box/Pcs	D (mm)	L (mm)	L1 (mm)	L2 (mm)	L3 (mm)	L4 (mm)	L5 (mm)	L6 (mm)	L7 (mm)	H (mm)
20	10	210 00 020 4	240,00 €	0,25	55	45	134	78	72	139	25	36	67	70	50
25	10	210 00 025 4	264,38 €	0,36	75	53	156	92	86	161	25	43	78	81	60
32	10	210 00 032 4	274,38 €	0,54	60	65	172	100	96	177	25	48	86	89	68
40	10	210 00 040 4	282,38 €	0,93	30	78	202	110	116	207	45	58	101	104	79
50	10	210 00 050 4	456,71 €	1,36	20	92	238	120	137	242	45	69	119	121	90
63	10	210 00 063 4	464,40 €	2,66	12	116	290	146	179	294	45	90	145	147	109

U-PVC Üç Yollu İçten Dişli Küresel Asit Vanası (T Port)
U-PVC Three Ways Female Threaded Ball Valve (T Port)

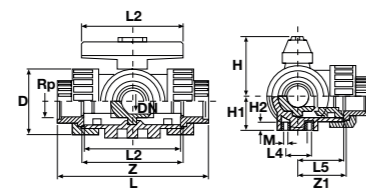

Çap Dia	Basınç PN	Kod Code	Fiyat (Adet) Price (Pcs)	Kg/Adet Kg/Pcs	Koli/Adet Box/Pcs	D (mm)	L (mm)	L1 (mm)	L2 (mm)	L4 (mm)	L5 (mm)	H (mm)	H1 (mm)
20	10	211 01 020 4	288,00 €	0,25	55	45	111	78	72	25	36	50	27
25	10	211 01 025 4	317,26 €	0,36	75	53	131	92	86	25	43	60	33
32	10	211 01 032 4	329,26 €	0,54	60	65	148	100	96	25	48	68	36
40	10	211 01 040 4	338,86 €	0,93	30	78	176	110	116	45	58	79	44
50	10	211 01 050 4	548,05 €	1,4	20	92	206	120	137	45	69	90	49
63	10	211 01 063 4	557,28 €	2,66	12	116	262	146	179	45	90	109	61

U-PVC Küresel Asit Vanası Çift Taraf Flanş Bağlantılı (Pozisyon Ayarlı)
U-PVC Both Sides Female Flanged True Union Ball Valve Position Regulated For Acid

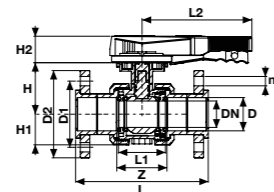

Düşük Dayanımlı Asit İçin For Low Strength Acid
Yüksek Dayanımlı Asit İçin For High Strength Acid

Çap Dia	Basınç PN	Kod / Code EPDM PTFE O-Ring	Fiyat (Adet) Price (Pcs)	Kod / Code FPM & PTFE O-Ring	Fiyat (Adet) Price (Pcs)	Koli/Adet Box/Pcs	DN (mm)	Z (mm)	L1 (mm)	L2 (mm)	L (mm)	H (mm)	H1 (mm)	H2 (mm)	D1 (mm)	D2 (mm)	n (mmxAdet)
63	16	209 10 063 2	51,25 €	237 10 063 2	76,88 €	12	50	98	87	207,5	172	101	58	48	125	165	18 x 4
75	16	209 10 075 2	106,00 €	237 10 075 2	159,00 €	9	65	119	98	207,5	196	110	73	50	145	185	18 x 4
90	16	209 10 090 2	121,25 €	237 10 090 2	181,88 €	4	80	156	126	207,5	241	137	90	52	160	200	18 x 8
110	16	209 10 110 2	198,00 €	237 10 110 2	297,00 €	2	100	185	150	259,5	289	150	106	52	180	220	18 x 8

U-PVC Küresel Asit Vanası (Pozisyon Ayarlı)
U-PVC True Union Ball Valve Position Regulated For Acid

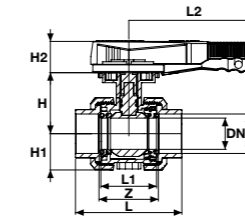

Düşük Dayanımlı Asit İçin For Low Strength Acid
Yüksek Dayanımlı Asit İçin For High Strength Acid

Çap Dia	Basınç PN	Kod / Code EPDM PTFE O-Ring	Fiyat (Adet) Price (Pcs)	Kod / Code FPM & PTFE O-Ring	Fiyat (Adet) Price (Pcs)	Kg/Adet Kg/Pcs	Koli/Adet Box/Pcs	DN (mm)	Z (mm)	L1 (mm)	L2 (mm)	L (mm)	H (mm)	H1 (mm)	H2 (mm)	kv l/min
63	16	205 10 063 2	27,40 €	234 10 063 2	41,10 €	1,16	12	50	98	87	207,5	172	101	58	48	3100
75	16	205 10 075 2	66,00 €	234 10 075 2	99,00 €	1,46	9	65	119	98	207,5	196	110	73	50	5000
90	16	205 10 090 2	85,50 €	234 10 090 2	128,25 €	3,51	4	80	156	126	207,5	241	137	89	52	7000
110	16	205 10 110 2	108,00 €	234 10 110 2	162,00 €	3,40	2	100	185	150	259,5	289	150	105	52	11000

U-PVC Küresel Asit Vanası Tek Taraf İç Dişli (Pozisyon Ayarlı)
U-PVC One Side Female Threaded True Union Ball Valve Position Regulated For Acid

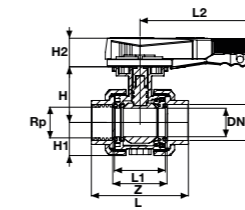

Düşük Dayanımlı Asit İçin For Low Strength Acid
Yüksek Dayanımlı Asit İçin For High Strength Acid

Çap Dia (Inch)	Rp (Inch)	Basınç PN	Kod / Code EPDM PTFE O-Ring	Fiyat (Adet) Price (Pcs)	Kod / Code FPM & PTFE O-Ring	Fiyat (Adet) Price (Pcs)	Kg/Adet Kg/Pcs	Koli/Adet Box/Pcs	DN (mm)	kv l/min	Z (mm)	L1 (mm)	L2 (mm)	L (mm)	H (mm)	H1 (mm)	H2 (mm)
63	2"	16	206 10 063 2	29,35 €	235 10 063 2	44,03 €	1,16	12	50	3100	98	87	207,5	172	101	58	48
75	2 1/2"	16	206 10 075 2	69,00 €	235 10 075 2	103,50 €	1,46	9	65	5000	119	98	207,5	196	110	73	50
90	3"	16	206 10 090 2	88,50 €	235 10 090 2	132,75 €	3,54	4	80	7000	156	126	207,5	241	137	89	52
110	4"	16	206 10 110 2	118,00 €	235 10 110 2	177,00 €	5,29	2	100	11000	185	150	259,5	289	150	105	52

U-PVC Küresel Asit Vanası Çift Taraf İç Dişli (Pozisyon Ayarlı)
U-PVC Both Sides Female Threaded True Union Ball Valve Position Regulated For Acid

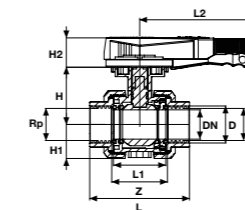

Düşük Dayanımlı Asit İçin For Low Strength Acid
Yüksek Dayanımlı Asit İçin For High Strength Acid

Rp (Inch)	Basınç PN	Kod / Code EPDM PTFE O-Ring	Fiyat (Adet) Price (Pcs)	Kod / Code FPM & PTFE O-Ring	Fiyat (Adet) Price (Pcs)	Kg/Adet Kg/Pcs	Koli/Adet Box/Pcs	DN (mm)	Z (mm)	L1 (mm)	L2 (mm)	L (mm)	H (mm)	H1 (mm)	H2 (mm)	kv l/min
2"	16	207 10 063 2	31,30 €	236 10 063 2	46,95 €	1,19	12	50	98	87	207,5	172	101	58	48	3100
2 1/2"	16	207 10 075 2	72,00 €	236 10 075 2	108,00 €	1,19	9	65	119	98	207,5	196	110	73	50	5000
3"	16	207 10 090 2	91,50 €	236 10 090 2	137,25 €	1,19	4	80	156	126	207,5	241	137	89	52	7000
4"	16	207 10 110 2	123,50 €	236 10 110 2	185,25 €	1,19	2	100	185	150	259,5	289	150	105	52	11000

Not / Note

U-PVC

AKTÜATÖRLÜ KÜRESEL VANA ACTUATOR BALL VALVE

ÜRETİM STANDARDI

PRODUCTION STANDARD

TS EN ISO 16135

ÇAP / SIZE Ø20 - Ø400



U-PVC Aktüatör Uyumlu Küresel Vana

U-PVC Actuator Mountable True Union Ball Valves

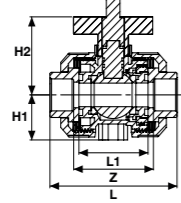

Çap Dia	Basınç PN	DN (mm)	kv l/min	Z (mm)	L1 (mm)	L (mm)	H1 (mm)	H2 (mm)	ISO 5211 Flanş ISO 5211 Interface	Kg/Adet Kg/Pcs	Koli/Adet Box/Pcs
20	16	15	185	52	45	85	27	79	F 03	0,156	1
25	16	20	350	58	49	95	31	87	F 03	0,206	1
32	16	25	700	61	54	107	33	91	F 05	0,267	1
40	16	32	1000	73	66	128	41	107	F 05	0,442	1
50	16	40	1600	82	75	154	46	127	F 05	0,69	1
63	16	50	3100	95	89	172	58	164	F 07	1,145	1
75	16	65	5000	118	111	196	65	178	F 07	1,51	1
90	16	80	7000	139	126	241	89	226	F 07	3,58	1
110	16	100	11000	165	153	289	105	258	F 07	5,48	1

Su İçin For Water

Çap Dia	EPDM Conta Kod EPDM O-Ring Code	Fiyat (Adet) Price (Pcs)
20	300 01 020 2	6,76 €
25	300 01 025 2	7,15 €
32	300 01 032 2	8,45 €
40	300 01 040 2	9,10 €
50	300 01 050 2	10,66 €
63	300 01 063 2	14,04 €
75	300 01 075 2	36,40 €
90	300 01 090 2	48,10 €
110	300 01 110 2	71,50 €

Düşük Dayanımlı Asit İçin For Low Strength Acid

EPDM & PTFE Conta Kod EPDM & PTFE O-Ring Code	Fiyat (Adet) Price (Pcs)
300 02 020 2	9,62 €
300 02 025 2	12,22 €
300 02 032 2	16,38 €
300 02 040 2	20,28 €
300 02 050 2	23,66 €
300 02 063 2	28,60 €
300 02 075 2	67,60 €
300 02 090 2	87,10 €
300 02 110 2	111,80 €

Yüksek Dayanımlı Asit İçin For High Strength Acid

FPM & PTFE Conta Kod FPM & PTFE O-Ring Code	Fiyat (€/Adet) Price (€/Pcs)
301 02 020 2	14,43 €
301 02 025 2	18,33 €
301 02 032 2	24,57 €
301 02 040 2	30,42 €
301 02 050 2	35,49 €
301 02 063 2	42,90 €
301 02 075 2	101,25 €
301 02 090 2	130,65 €
301 02 110 2	167,70 €

U-PVC Aktüatör Uyumlu Küresel Vana (Çift Taraf İçten Dişli)

U-PVC Actuator Mountable True Union Ball Valves (Both Sides Female Threaded)

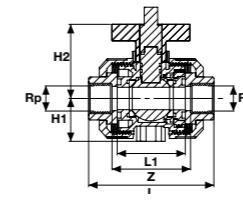

Çap Dia	Rp (Inch)	Basınç PN	DN (mm)	kv l/min	Z (mm)	L1 (mm)	L (mm)	H1 (mm)	H2 (mm)	ISO 5211 Flanş ISO 5211 Interface	Kg/Adet Kg/Pcs	Koli/Adet Box/Pcs
20	1/2"	16	15	185	52	45	85	27	79	F 03	0,15	1
25	3/4"	16	20	350	58	49	95	31	87	F 03	0,20	1
32	1"	16	25	700	61	54	107	33	91	F 05	0,26	1
40	1 1/4"	16	32	1000	73	66	128	41	107	F 05	0,44	1
50	1 1/2"	16	40	1600	82	75	154	46	127	F 05	0,69	1
63	2"	16	50	3100	95	89	172	58	164	F 07	1,14	1
75	2 1/2"	16	65	5000	118	111	196	65	178	F 07	1,51	1
90	3"	16	80	7000	139	126	241	89	226	F 07	3,58	1
110	4"	16	100	11000	165	153	289	105	258	F 07	5,48	1

Su İçin For Water

Rp (Inch)	EPDM Conta Kod EPDM O-Ring Code	Fiyat (Adet) Price (Pcs)
1/2"	300 05 020 2	9,10 €
3/4"	300 05 025 2	9,62 €
1"	300 05 032 2	11,57 €
1 1/4"	300 05 040 2	12,22 €
1 1/2"	300 05 050 2	14,04 €
2"	300 05 063 2	17,42 €
2 1/2"	300 05 075 2	41,60 €
3"	300 05 090 2	53,30 €
4"	300 05 110 2	79,30 €

Düşük Dayanımlı Asit İçin For Low Strength Acid

EPDM & PTFE Conta Kod EPDM & PTFE O-Ring Code	Fiyat (Adet) Price (Pcs)
300 06 020 2	11,96 €
300 06 025 2	14,56 €
300 06 032 2	18,46 €
300 06 040 2	22,36 €
300 06 050 2	27,04 €
300 06 063 2	31,98 €
300 06 075 2	72,80 €
300 06 090 2	92,30 €
300 06 110 2	120,90 €

Yüksek Dayanımlı Asit İçin For High Strength Acid

FPM & PTFE Conta Kod FPM & PTFE O-Ring Code	Fiyat (Adet) Price (Pcs)
301 06 020 2	17,94 €
301 06 025 2	21,84 €
301 06 032 2	27,69 €
301 06 040 2	33,54 €
301 06 050 2	40,56 €
301 06 063 2	47,94 €
301 06 075 2	109,20 €
301 06 090 2	138,45 €
301 06 110 2	181,35 €

U-PVC Aktüatör Uyumlu Küresel Vana (Tek Taraf İçten Dişli)

U-PVC Actuator Mountable True Union Ball Valves (One Sides Female Threaded)

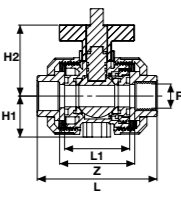

Çap Dia	Rp (Inch)	Basınç PN	DN (mm)	kv l/min	Z (mm)	L1 (mm)	L (mm)	H1 (mm)	H2 (mm)	ISO 5211 Flanş ISO 5211 Interface	Kg/Adet Kg/Pcs	Koli/Adet Box/Pcs
20	1/2"	16	15	185	52	45	85	27	79	F 03	0,15	1
25	3/4"	16	20	350	58	49	95	31	87	F 03	0,20	1
32	1"	16	25	700	61	54	107	33	91	F 05	0,26	1
40	1 1/4"	16	32	1000	73	66	128	41	107	F 05	0,44	1
50	1 1/2"	16	40	1600	82	75	154	46	127	F 05	0,69	1
63	2"	16	50	3100	95	89	172	58	164	F 07	1,14	1
75	2 1/2"	16	65	5000	118	111	196	65	178	F 07	1,51	1
90	3"	16	80	7000	139	126	241	89	226	F 07	3,58	1
110	4"	16	100	11000	165	153	289	105	258	F 07	5,48	1

Su İçin For Water

Çap Dia	Rp (Inch)	EPDM Conta Kod EPDM O-Ring Code	Fiyat (Adet) Price (Pcs)
20	1/2"	300 03 020 2	7,93 €
25	3/4"	300 03 025 2	8,45 €
32	1"	300 03 032 2	10,14 €
40	1 1/4"	300 03 040 2	10,79 €
50	1 1/2"	300 03 050 2	12,35 €
63	2"	300 03 063 2	15,73 €
75	2 1/2"	300 03 075 2	39,00 €
90	3"	300 03 090 2	50,70 €
110	4"	300 03 110 2	75,40 €

Düşük Dayanımlı Asit İçin For Low Strength Acid

EPDM & PTFE Conta Kod EPDM & PTFE O-Ring Code	Fiyat (Adet) Price (Pcs)
300 04 020 2	10,76 €
300 04 025 2	13,52 €
300 04 032 2	18,07 €
300 04 040 2	21,97 €
300 04 050 2	25,35 €
300 04 063 2	30,29 €
300 04 075 2	70,20 €
300 04 090 2	89,70 €
300 04 110 2	115,70 €

Yüksek Dayanımlı Asit İçin For High Strength Acid

FPM & PTFE Conta Kod FPM & PTFE O-Ring Code	Fiyat (Adet) Price (Pcs)
301 04 020 2	16,14 €
301 04 025 2	20,28 €
301 04 032 2	27,11 €
301 04 040 2	32,96 €
301 04 050 2	38,03 €
301 04 063 2	45,42 €
301 04 075 2	105,30 €
301 04 090 2	134,55 €
301 04 110 2	173,55 €

U-PVC Aktüatör Uyumlu Küresel Vana (Çift Taraf Flanş Bağlantılı)

U-PVC Actuator Mountable True Union Ball Valves (Both Sides Flanged)

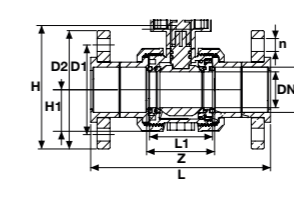

Çap Dia	Basınç PN	DN (mm)	kv l/min	Z (mm)	L1 (mm)	L (mm)	H (mm)	H1 (mm)	D1 (mm)	D2 (mm)	n (mm)	ISO 5211 Flanş ISO 5211 Interface	Kg/Adet Kg/Pcs	Koli/Adet Box/Pcs
20	16	15	185	52	45	123	131	27	65	96	14x4	F 03	0,37	1
25	16	20	350	58	49	140	133	31	75	105	14x4	F 03	0,49	1
32	16	25	700	61	54	158	141	33	85	115	14x4	F 05	0,68	1
40	16	32	1000	73	66	186	157	41	100	140	14x4	F 05	1,10	1
50	16	40	1600	82	75	231	182	46	100	150	18x4	F 05	1,48	1
63	16	50	3100	95	89	253	218	58	125	165	18x4	F 07	2,34	1
75	16	65	5000	118	111	291	228	65	145	185	22x4	F 07	3,03	1
90	16	80	7000	139	126	353	252	89	160	200	22x8	F 07	5,54	1
110	16	100	11000	165	153	431	276	105	180	220	24x8	F 07	8,10	1

Su İçin For Water

Çap Dia	EPDM Conta Kod EPDM O-Ring Code	Fiyat (Adet) Price (Pcs)
20	300 07 020 2	21,19 €
25	300 07 025 2	22,62 €
32	300 07 032 2	23,86 €
40	300 07 040 2	25,35 €
50	300 07 050 2	31,20 €
63	300 07 063 2	34,45 €
75	300 07 075 2	67,60 €
90	300 07 090 2	81,25 €
110	300 07 110 2	136,11 €

Düşük Dayanımlı Asit İçin For Low Strength Acid

EPDM & PTFE Conta Kod EPDM & PTFE O-Ring Code	Fiyat (Adet) Price (Pcs)
300 08 020 2	25,35 €
300 08 025 2	27,95 €
300 08 032 2	32,50 €
300 08 040 2	39,00 €
300 08 050 2	42,90 €
300 08 063 2	49,40 €
300 08 075 2	104,00 €
300 08 090 2	117,00 €
300 08 110 2	201,50 €

Yüksek Dayanımlı Asit İçin For High Strength Acid

FPM & PTFE Conta Kod FPM & PTFE O-Ring Code	Fiyat (Adet) Price (Pcs)
301 08 020 2	38,03 €
301 08 025 2	41,93 €
301 08 032 2	48,75 €
301 08 040 2	58,50 €
301 08 050 2	64,35 €
301 08 063 2	74,10 €
301 08 075 2	156,00 €
301 08 090 2	175,50 €
301 08 110 2	302,25 €

U-PVC Elektrik Aktüatörlü Yapıştırma Muflu Küresel Vana 24 V DC/24 V AC
 U-PVC Electric Actuator Solvent Cement True Union Ball Valve 24 V DC/24 V AC

Çap Dia	Basınç PN	DN (mm)	kv l/min	Z (mm)	L1 (mm)	L (mm)	H (mm)	H1 (mm)	ISO 5211 Flanş ISO 5211 Interface	Kg/Adet Kg/Pcs	Koli/Adet Box/Pcs
20	16	15	185	52	45	85	27		F 03	1,44	1
25	16	20	350	58	49	95	31		F 03	1,49	1
32	16	25	700	61	54	107	33		F 05	1,54	1
40	16	32	1000	73	66	128	41		F 05	1,72	1
50	16	40	1600	82	75	154	46		F 05	1,95	1
63	16	50	3100	95	89	172	58		F 07	2,40	1
75	16	65	5000	118	111	196	65		F 07	3,96	1
90	16	80	7000	139	126	241	89		F 07	6,01	1
110	16	100	11000	165	153	289	105		F 07	7,91	1

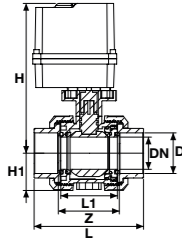
Su İçin
 For Water

Çap Dia	EPDM Conta Kod EPDM O-Ring Code	Fiyat (Adet) Price (Pcs)
20	300 00 020 2	230,30 €
25	300 00 025 2	230,30 €
32	300 00 032 2	230,30 €
40	300 00 040 2	252,20 €
50	300 00 050 2	240,10 €
63	300 00 063 2	296,94 €
75	300 00 075 2	343,00 €
90	300 00 090 2	380,24 €
110	300 00 110 2	416,50 €

Düşük Dayanımlı Asit İçin
 For Low Strength Acid

Çap Dia	EPDM & PTFE Conta Kod EPDM & PTFE O-Ring Code	Fiyat (Adet) Price (Pcs)
20	300 10 020 2	232,50 €
25	300 10 025 2	234,20 €
32	300 10 032 2	236,40 €
40	300 10 040 2	243,80 €
50	300 10 050 2	250,10 €
63	300 10 063 2	308,10 €
75	300 10 075 2	367,00 €
90	300 10 090 2	410,20 €
110	300 10 110 2	447,50 €

Yüksek Dayanımlı Asit İçin
 For High Strength Acid

Çap Dia	FPM & PTFE Conta Kod FPM & PTFE O-Ring Code	Fiyat (Adet) Price (Pcs)
20	301 10 020 2	242,50 €
25	301 10 025 2	244,20 €
32	301 10 032 2	246,40 €
40	301 10 040 2	253,80 €
50	301 10 050 2	270,10 €
63	301 10 063 2	328,10 €
75	301 10 075 2	412,00 €
90	301 10 090 2	455,20 €
110	301 10 110 2	492,50 €

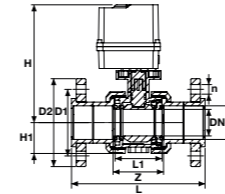

Çap Dia	Basınç PN	DN (mm)	kv l/min	Z (mm)	L1 (mm)	L (mm)	H (mm)	H1 (mm)	D1 (mm)	D2 (mm)	n (mm)	ISO 5211 Flanş ISO 5211 Interface	Kg/Adet Kg/Pcs	Koli/Adet Box/Pcs
20	16	15	185	60	48	123	209	27	65	96	14x4	F 03	1,66	1
25	16	20	350	58	45	140	215	31	75	105	14x4	F 03	1,77	1
32	16	25	700	68	49	158	225	33	85	115	14x4	F 05	1,96	1
40	16	32	1000	82	54	186	238	41	100	140	14x4	F 05	2,38	1
50	16	40	1600	94	65	231	253	46	100	150	18x4	F 05	2,74	1
63	16	50	3100	98	74	253	288	58	125	165	18x4	F 07	3,59	1
75	16	65	5000	119	87	291	305	65	145	185	22x4	F 07	5,49	1
90	16	80	7000	156	98	353	352	89	160	200	22x8	F 07	7,97	1
110	16	100	11000	185	150	431	385	105	180	220	24x8	F 07	10,5	1

Su İçin
 For Water

Çap Dia	EPDM Conta Kod EPDM O-Ring Code	Fiyat (Adet) Price (Pcs)
20	306 00 020 2	241,40 €
25	306 00 025 2	242,20 €
32	306 00 032 2	242,20 €
40	306 00 040 2	247,70 €
50	306 00 050 2	255,90 €
63	306 00 063 2	312,60 €
75	306 00 075 2	367,00 €
90	306 00 090 2	405,70 €
110	306 00 110 2	466,20 €

Düşük Dayanımlı Asit İçin
 For Low Strength Acid

Çap Dia	EPDM & PTFE Conta Kod EPDM & PTFE O-Ring Code	Fiyat (Adet) Price (Pcs)
20	306 10 020 2	244,60 €
25	306 10 025 2	246,30 €
32	306 10 032 2	248,80 €
40	306 10 040 2	258,20 €
50	306 10 050 2	264,90 €
63	306 10 063 2	324,10 €
75	306 10 075 2	395,00 €
90	306 10 090 2	433,20 €
110	306 10 110 2	516,50 €

Yüksek Dayanımlı Asit İçin
 For High Strength Acid

Çap Dia	FPM & PTFE Conta Kod FPM & PTFE O-Ring Code	Fiyat (Adet) Price (Pcs)
20	306 20 020 2	254,60 €
25	306 20 025 2	256,30 €
32	306 20 032 2	258,80 €
40	306 20 040 2	268,20 €
50	306 20 050 2	284,90 €
63	306 20 063 2	344,10 €
75	306 20 075 2	440,00 €
90	306 20 090 2	478,20 €
110	306 20 110 2	561,50 €

U-PVC Elektrik Aktüatörlü Yapıştırma Muflu Küresel Vana 110-260 V AC
 U-PVC Electric Actuator Solvent Cement True Union Ball Valve 110-260 V AC

Çap Dia	Basınç PN	DN (mm)	kv l/min	Z (mm)	L1 (mm)	L (mm)	H (mm)	H1 (mm)	ISO 5211 Flanş ISO 5211 Interface	Kg/Adet Kg/Pcs	Koli/Adet Box/Pcs
20	16	15	185	52	45	85	209	27	F 03	1,44	1
25	16	20	350	58	49	95	215	31	F 03	1,49	1
32	16	25	700	61	54	107	225	33	F 05	1,54	1
40	16	32	1000	73	66	128	238	41	F 05	1,72	1
50	16	40	1600	82	75	154	253	46	F 05	1,95	1
63	16	50	3100	95	89	172	288	58	F 07	2,40	1
75	16	65	5000	118	111	196	305	65	F 07	3,96	1
90	16	80	7000	139	126	241	352	89	F 07	6,01	1
110	16	100	11000	165	153	289	385	105	F 07	7,91	1

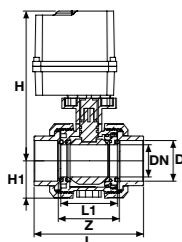
Su İçin
 For Water

Çap Dia	EPDM Conta Kod EPDM O-Ring Code	Fiyat (Adet) Price (Pcs)
20	301 00 020 2	230,30 €
25	301 00 025 2	230,30 €
32	301 00 032 2	230,30 €
40	301 00 040 2	232,20 €
50	301 00 050 2	240,10 €
63	301 00 063 2	296,94 €
75	301 00 075 2	343,00 €
90	301 00 090 2	380,24 €
110	301 00 110 2	416,50 €

Düşük Dayanımlı Asit İçin
 For Low Strength Acid

Çap Dia	EPDM & PTFE Conta Kod EPDM & PTFE O-Ring Code	Fiyat (Adet) Price (Pcs)
20	301 30 020 2	232,50 €
25	301 30 025 2	234,20 €
32	301 30 032 2	236,40 €
40	301 30 040 2	243,80 €
50	301 30 050 2	250,10 €
63	301 30 063 2	308,10 €
75	301 30 075 2	367,00 €
90	301 30 090 2	410,20 €
110	301 30 110 2	447,50 €

Yüksek Dayanımlı Asit İçin
 For High Strength Acid

Çap Dia	FPM & PTFE Conta Kod FPM & PTFE O-Ring Code	Fiyat (Adet) Price (Pcs)
20	301 20 020 2	242,50 €
25	301 20 025 2	244,20 €
32	301 20 032 2	246,40 €
40	301 20 040 2	253,80 €
50	301 20 050 2	270,10 €
63	301 20 063 2	328,10 €
75	301 20 075 2	412,00 €
90	301 20 090 2	455,20 €
110	301 20 110 2	492,50 €

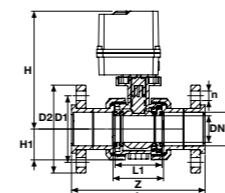

Çap Dia	Basınç PN	DN (mm)	kv l/min	Z (mm)	L1 (mm)	L (mm)	H (mm)	H1 (mm)	D1 (mm)	D2 (mm)	n (mm)	ISO 5211 Flanş ISO 5211 Interface	Kg/Adet Kg/Pcs	Koli/Adet Box/Pcs
20	16	15	185	60	48	123	209	27	65	96	14x4	F 03	1,66	1
25	16	20	350	58	45	140	215	31	75	105	14x4	F 03	1,77	1
32	16	25	700	68	49	158	225	33	85	115	14x4	F 05	1,96	1
40	16	32	1000	82	54	186	238	41	100	140	14x4	F 05	2,38	1
50	16	40	1600	94	65	231	253	46	100	150	18x4	F 05	2,74	1
63	16	50	3100	98	74	253	288	58	125	165	18x4	F 07	3,59	1
75	16	65	5000	119	87	291	305	65	145	185	22x4	F 07	5,49	1
90	16	80	7000	156	98	353	352	89	160	200	22x8	F 07	7,97	1
110	16	100	11000	185	150	431	385	105	180	220	24x8	F 07	10,5	1

Su İçin
 For Water

Çap Dia	EPDM Conta Kod EPDM O-Ring Code	Fiyat (Adet) Price (Pcs)
20	307 00 020 2	241,40 €
25	307 00 025 2	242,20 €
32	307 00 032 2	242,20 €
40	307 00 040 2	247,70 €
50	307 00 050 2	255,90 €
63	307 00 063 2	312,60 €
75	307 00 075 2	367,00 €
90	307 00 090 2	405,70 €
110	307 00 110 2	466,20 €

Düşük Dayanımlı Asit İçin
 For Low Strength Acid

Çap Dia	EPDM & PTFE Conta Kod EPDM & PTFE O-Ring Code	Fiyat (Adet) Price (Pcs)
20	307 10 020 2	244,60 €
25	307 10 025 2	246,30 €
32	307 10 032 2	248,80 €
40	307 10 040 2	258,20 €
50	307 10 050 2	264,90 €
63	307 10 063 2	324,10 €
75	307 10 075 2	395,00 €
90	307 10 090 2	433,20 €
110	307 10 110 2	516,50 €

Yüksek Dayanımlı Asit İçin
 For High Strength Acid

Çap Dia	FPM & PTFE Conta Kod FPM & PTFE O-Ring Code	Fiyat (Adet) Price (Pcs)
20	307 20 020 2	254,60 €
25	307 20 025 2	256,30 €
32	307 20 032 2	258,80 €
40	307 20 040 2	268,20 €
50	307 20 050 2	284,90 €
63	307 20 063 2	344,10 €
75	307 20 075 2	440,00 €
90	307 20 090 2	478,20 €
110	307 20 110 2	561,50 €

U-PVC Elektrik Aktüatörlü Yapıştırma Muflu Küresel Vana Tek Taraf İç Dişli 24 V DC
 U-PVC True Union Ball Valve With Electric Actuator One Side Female Threaded 24 V DC

Çap Dia	Rp (Inch)	Basınç PN	DN (mm)	kv l/min	Z (mm)	L1 (mm)	L (mm)	H (mm)	H1 (mm)	ISO 5211 Flanş ISO 5211 Interface	Kg/Adet Kg/Pcs	Koli/Adet Box/Pcs
20	1/2"	16	15	185	52	45	85	209	27	F 03	1,44	1
25	3/4"	16	20	350	58	49	95	215	31	F 03	1,49	1
32	1"	16	25	700	61	54	107	225	33	F 05	1,54	1
40	1 1/4"	16	32	1000	73	66	128	238	41	F 05	1,72	1
50	1 1/2"	16	40	1600	82	75	154	253	46	F 05	1,95	1
63	2"	16	50	3100	95	89	172	288	58	F 07	2,40	1
75	2 1/2"	16	65	5000	118	111	196	305	65	F 07	3,96	1
90	3"	16	80	7000	139	126	241	352	89	F 07	6,01	1
110	4"	16	100	11000	165	153	289	385	105	F 07	7,91	1

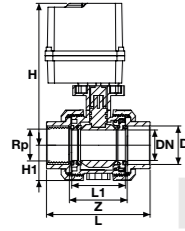
Su İçin
For Water

Düşük Dayanımlı Asit İçin
For Low Strength Acid

Yüksek Dayanımlı Asit İçin
For High Strength Acid

Çap Dia	Rp (Inch)	EPDM Conta Kod EPDM O-Ring Code	Fiyat (Adet) Price (Pcs)	EPDM & PTFE Conta Kod EPDM & PTFE O-Ring Code	Fiyat (Adet) Price (Pcs)	FPM & PTFE Conta Kod FPM & PTFE O-Ring Code	Fiyat (Adet) Price (Pcs)
20	1/2"	302 00 020 2	231,20 €	302 10 020 2	233,40 €	302 20 020 2	243,40 €
25	3/4"	302 00 025 2	231,30 €	302 10 025 2	235,20 €	302 20 025 2	245,20 €
32	1"	302 00 032 2	231,60 €	302 10 032 2	237,70 €	302 20 032 2	247,70 €
40	1 1/4"	302 00 040 2	236,50 €	302 10 040 2	245,10 €	302 20 040 2	255,10 €
50	1 1/2"	302 00 050 2	241,40 €	302 10 050 2	251,40 €	302 20 050 2	271,40 €
63	2"	302 00 063 2	298,20 €	302 10 063 2	309,40 €	302 20 063 2	329,40 €
75	2 1/2"	302 00 075 2	345,00 €	302 10 075 2	369,00 €	302 20 075 2	414,00 €
90	3"	302 00 090 2	382,20 €	302 10 090 2	412,20 €	302 20 090 2	457,20 €
110	4"	302 00 110 2	419,50 €	302 10 110 2	450,50 €	302 20 110 2	495,50 €

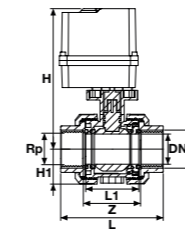

Rp (Inch)	Basınç PN	DN (mm)	kv l/min	Z (mm)	L1 (mm)	L (mm)	H (mm)	H1 (mm)	ISO 5211 Flanş ISO 5211 Interface	Kg/Adet Kg/Pcs	Koli/Adet Box/Pcs
1/2"	16	15	185	52	45	85	209	27	F 03	1,44	1
3/4"	16	20	350	58	49	95	215	31	F 03	1,49	1
1"	16	25	700	61	54	107	225	33	F 05	1,54	1
1 1/4"	16	32	1000	73	66	128	238	41	F 05	1,72	1
1 1/2"	16	40	1600	82	75	154	253	46	F 05	1,95	1
2"	16	50	3100	95	89	172	288	58	F 07	2,40	1
2 1/2"	16	65	5000	118	111	196	305	65	F 07	3,96	1
3"	16	80	7000	139	126	241	352	89	F 07	6,01	1
4"	16	100	11000	165	153	289	385	105	F 07	7,91	1

Su İçin
For Water

Düşük Dayanımlı Asit İçin
For Low Strength Acid

Yüksek Dayanımlı Asit İçin
For High Strength Acid

Rp (Inch)	EPDM Conta Kod EPDM O-Ring Code	Fiyat (Adet) Price (Pcs)	EPDM & PTFE Conta Kod EPDM & PTFE O-Ring Code	Fiyat (Adet) Price (Pcs)	FPM & PTFE Conta Kod FPM & PTFE O-Ring Code	Fiyat (Adet) Price (Pcs)
1/2"	304 00 020 2	232,10 €	304 10 020 2	234,30 €	304 20 020 2	244,30 €
3/4"	304 00 025 2	232,20 €	304 10 025 2	236,00 €	304 20 025 2	246,00 €
1"	304 00 032 2	232,70 €	304 10 032 2	238,00 €	304 20 032 2	248,00 €
1 1/4"	304 00 040 2	237,60 €	304 10 040 2	245,40 €	304 20 040 2	255,40 €
1 1/2"	304 00 050 2	242,70 €	304 10 050 2	252,70 €	304 20 050 2	272,70 €
2"	304 00 063 2	299,50 €	304 10 063 2	310,70 €	304 20 063 2	309,70 €
2 1/2"	304 00 075 2	347,00 €	304 10 075 2	371,00 €	304 20 075 2	416,00 €
3"	304 00 090 2	384,20 €	304 10 090 2	414,20 €	304 20 090 2	459,20 €
4"	304 00 110 2	422,50 €	304 10 110 2	454,50 €	304 20 110 2	499,50 €

U-PVC Elektrik Aktüatörlü Yapıştırma Muflu Küresel Vana Tek Taraf İç Dişli 110-260 V AC
 U-PVC True Union Ball Valve With Electric Actuator One Side Female Threaded 110-260 V AC

Çap Dia	Rp (Inch)	Basınç PN	DN (mm)	kv l/min	Z (mm)	L1 (mm)	L (mm)	H (mm)	H1 (mm)	ISO 5211 Flanş ISO 5211 Interface	Kg/Adet Kg/Pcs	Koli/Adet Box/Pcs
20	1/2"	16	15	185	52	45	85	209	27	F 03	1,44	1
25	3/4"	16	20	350	58	49	95	215	31	F 03	1,49	1
32	1"	16	25	700	61	54	107	225	33	F 05	1,54	1
40	1 1/4"	16	32	1000	73	66	128	238	41	F 05	1,72	1
50	1 1/2"	16	40	1600	82	75	154	253	46	F 05	1,95	1
63	2"	16	50	3100	95	89	172	288	58	F 07	2,40	1
75	2 1/2"	16	65	5000	118	111	196	305	65	F 07	3,96	1
90	3"	16	80	7000	139	126	241	352	89	F 07	6,01	1
110	4"	16	100	11000	165	153	289	385	105	F 07	7,91	1

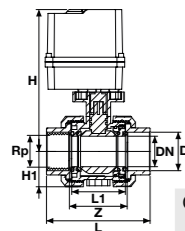
Su İçin
For Water

Düşük Dayanımlı Asit İçin
For Low Strength Acid

Yüksek Dayanımlı Asit İçin
For High Strength Acid

Çap Dia	Rp (Inch)	EPDM Conta Kod EPDM O-Ring Code	Fiyat (Adet) Price (Pcs)	EPDM & PTFE Conta Kod EPDM & PTFE O-Ring Code	Fiyat (Adet) Price (Pcs)	FPM & PTFE Conta Kod FPM & PTFE O-Ring Code	Fiyat (Adet) Price (Pcs)
20	1/2"	303 00 020 2	231,20 €	303 10 020 2	233,40 €	303 20 020 2	243,40 €
25	3/4"	303 00 025 2	231,30 €	303 10 025 2	235,20 €	303 20 025 2	245,20 €
32	1"	303 00 032 2	231,60 €	303 10 032 2	237,70 €	303 20 032 2	247,70 €
40	1 1/4"	303 00 040 2	236,50 €	303 10 040 2	245,10 €	303 20 040 2	255,10 €
50	1 1/2"	303 00 050 2	241,40 €	303 10 050 2	251,40 €	303 20 050 2	271,40 €
63	2"	303 00 063 2	298,20 €	303 10 063 2	309,40 €	303 20 063 2	329,40 €
75	2 1/2"	303 00 075 2	345,00 €	303 10 075 2	369,00 €	303 20 075 2	414,00 €
90	3"	303 00 090 2	404,84 €	303 10 090 2	412,20 €	303 20 090 2	457,20 €
110	4"	303 00 110 2	419,50 €	303 10 110 2	450,50 €	303 20 110 2	495,50 €

U-PVC Elektrik Aktüatörlü Yapıştırma Muflu Küresel Vana Çift Taraf İç Dişli 110-260 V AC
 U-PVC True Union Ball Valve With Electric Actuator Both Sides Female Threaded 110-260 V AC

Rp (Inch)	Basınç PN	DN (mm)	kv l/min	Z (mm)	L1 (mm)	L (mm)	H (mm)	H1 (mm)	ISO 5211 Flanş ISO 5211 Interface	Kg/Adet Kg/Pcs	Koli/Adet Box/Pcs
1/2"	16	15	185	52	45	85	209	27	F 03	1,44	1
3/4"	16	20	350	58	49	95	215	31	F 03	1,49	1
1"	16	25	700	61	54	107	225	33	F 05	1,54	1
1 1/4"	16	32	1000	73	66	128	238	41	F 05	1,72	1
1 1/2"	16	40	1600	82	75	154	253	46	F 05	1,95	1
2"	16	50	3100	95	89	172	288	58	F 07	2,40	1
2 1/2"	16	65	5000	118	111	196	305	65	F 07	3,96	1
3"	16	80	7000	139	126	241	352	89	F 07	6,01	1
4"	16	100	11000	165	153	289	385	105	F 07	7,91	1

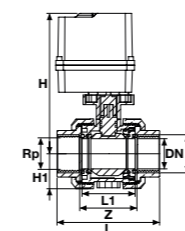
Su İçin
For Water

Düşük Dayanımlı Asit İçin
For Low Strength Acid

Yüksek Dayanımlı Asit İçin
For High Strength Acid

Rp (Inch)	EPDM Conta Kod EPDM O-Ring Code	Fiyat (Adet) Price (Pcs)	EPDM & PTFE Conta Kod EPDM & PTFE O-Ring Code	Fiyat (Adet) Price (Pcs)	FPM & PTFE Conta Kod FPM & PTFE O-Ring Code	Fiyat (Adet) Price (Pcs)
1/2"	305 00 020 2	232,10 €	305 10 020 2	234,30 €	305 20 020 2	244,30 €
3/4"	305 00 025 2	232,20 €	305 10 025 2	236,00 €	305 20 025 2	246,00 €
1"	305 00 032 2	232,70 €	305 10 032 2	238,00 €	305 20 032 2	248,00 €
1 1/4"	305 00 040 2	237,60 €	305 10 040 2	245,40 €	305 20 040 2	255,40 €
1 1/2"	305 00 050 2	242,70 €	305 10 050 2	252,70 €	305 20 050 2	272,70 €
2"	305 00 063 2	299,50 €	305 10 063 2	324,10 €	305 20 063 2	309,70 €
2 1/2"	305 00 075 2	347,00 €	305 10 075 2	371,00 €	305 20 075 2	416,00 €
3"	305 00 090 2	384,20 €	305 10 090 2	414,20 €	305 20 090 2	459,20 €
4"	305 00 110 2	422,50 €	305 10 110 2	454,50 €	305 20 110 2	499,50 €

U-PVC Pnömatik Aktüatörlü Tek Etkili Küresel Vana

U-PVC Pneumatic Actuator True Union Ball Valve Single Effect



Çap Dia	Basınç PN	DN (mm)	kv l/min	Z (mm)	L1 (mm)	L (mm)	H (mm)	H1 (mm)	ISO 5211 Flanş ISO 5211 Interface	Kg/Adet Kg/Pcs	Koli/Adet Box/Pcs
20	16	15	185	52	45	85	131	27	F 03	0,61	1
25	16	20	350	58	49	95	133	31	F 03	0,66	1
32	16	25	700	61	54	107	141	33	F 05	0,71	1
40	16	32	1000	73	66	128	157	41	F 05	1,55	1
50	16	40	1600	82	75	154	182	46	F 05	1,78	1
63	16	50	3100	95	89	172	218	58	F 07	2,23	1
75	16	65	5000	118	111	196	228	65	F 07	3,43	1
90	16	80	7000	139	126	241	252	89	F 07	6,44	1
110	16	100	11000	165	153	289	276	105	F 07	9,19	1

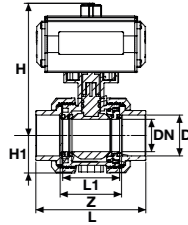

Su İçin
For Water

Düşük Dayanımlı Asit İçin
For Low Strength Acid

Yüksek Dayanımlı Asit İçin
For High Strength Acid

Çap Dia	EPDM Conta Kod EPDM O-Ring Code	Fiyat (Adet) Price (Pcs)	EPDM & PTFE Conta Kod EPDM & PTFE O-Ring Code	Fiyat (Adet) Price (Pcs)	FPM & PTFE Conta Kod FPM & PTFE O-Ring Code	Fiyat (Adet) Price (Pcs)
20	318 00 020 2	207,60 €	318 10 020 2	209,80 €	318 20 020 2	214,86 €
25	318 00 025 2	209,90 €	318 10 025 2	211,20 €	318 20 025 2	218,58 €
32	318 00 032 2	208,30 €	318 10 032 2	212,40 €	318 20 032 2	219,78 €
40	318 00 040 2	219,10 €	318 10 040 2	227,70 €	318 20 040 2	237,99 €
50	318 00 050 2	248,30 €	318 10 050 2	258,30 €	318 20 050 2	272,39 €
63	318 00 063 2	255,20 €	318 10 063 2	266,40 €	318 20 063 2	285,34 €
75	318 00 075 2	334,14 €	318 10 075 2	358,10 €	318 20 075 2	398,59 €
90	318 00 090 2	363,72 €	318 10 090 2	393,70 €	318 20 090 2	419,48 €
110	318 00 110 2	427,41 €	318 10 110 2	458,40 €	318 20 110 2	502,91 €



Çap Dia	Basınç PN	DN (mm)	kv l/min	Z (mm)	L1 (mm)	L (mm)	H (mm)	H1 (mm)	D1 (mm)	D2 (mm)	n (mm)	ISO 5211 Flanş ISO 5211 Interface	Kg/Adet Kg/Pcs	Koli/Adet Box/Pcs
20	16	15	185	52	45	123	131	27	65	96	14x4	F 03	0,83	1
25	16	20	350	58	49	140	133	31	75	105	14x4	F 03	0,94	1
32	16	25	700	61	54	158	141	33	85	115	14x4	F 05	1,13	1
40	16	32	1000	73	66	186	157	41	100	140	14x4	F 05	2,21	1
50	16	40	1600	82	75	231	182	46	100	150	18x4	F 05	2,57	1
63	16	50	3100	95	89	253	218	58	125	165	18x4	F 07	3,42	1
75	16	65	5000	118	111	291	228	65	145	185	22x4	F 07	4,96	1
90	16	80	7000	139	126	353	252	89	160	200	22x8	F 07	8,40	1
110	16	100	11000	165	153	431	276	105	180	220	24x8	F 07	11,8	1

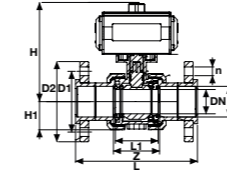

Su İçin
For Water

Düşük Dayanımlı Asit İçin
For Low Strength Acid

Yüksek Dayanımlı Asit İçin
For High Strength Acid

Çap Dia	EPDM Conta Kod EPDM O-Ring Code	Fiyat (Adet) Price (Pcs)	EPDM & PTFE Conta Kod EPDM & PTFE O-Ring Code	Fiyat (Adet) Price (Pcs)	FPM & PTFE Conta Kod FPM & PTFE O-Ring Code	Fiyat (Adet) Price (Pcs)
20	324 00 020 2	235,00 €	324 10 020 2	241,40 €	324 20 020 2	251,40 €
25	324 00 025 2	236,60 €	324 10 025 2	244,80 €	324 20 025 2	254,80 €
32	324 00 032 2	236,60 €	324 10 032 2	249,80 €	324 20 032 2	259,80 €
40	324 00 040 2	251,10 €	324 10 040 2	272,10 €	324 20 040 2	282,10 €
50	324 00 050 2	288,10 €	324 10 050 2	306,10 €	324 20 050 2	326,10 €
63	324 00 063 2	297,40 €	324 10 063 2	320,40 €	324 20 063 2	340,40 €
75	324 00 075 2	410,14 €	324 10 075 2	466,14 €	324 20 075 2	511,14 €
90	324 00 090 2	451,72 €	324 10 090 2	506,72 €	324 20 090 2	551,72 €
110	324 00 110 2	581,81 €	324 10 110 2	682,41 €	324 20 110 2	724,41 €

U-PVC Pnömatik Aktüatörlü Çift Etkili Küresel Vana

U-PVC Pneumatic Actuator True Union Ball Valve Double Effect



Çap Dia	Basınç PN	DN (mm)	kv l/min	Z (mm)	L1 (mm)	L (mm)	H (mm)	H1 (mm)	ISO 5211 Flanş ISO 5211 Interface	Kg/Adet Kg/Pcs	Koli/Adet Box/Pcs
20	16	15	185	52	45	85	131	27	F 03	0,61	1
25	16	20	350	58	49	95	133	31	F 03	0,66	1
32	16	25	700	61	54	107	141	33	F 05	0,71	1
40	16	32	1000	73	66	128	157	41	F 05	1,55	1
50	16	40	1600	82	75	154	182	46	F 05	1,78	1
63	16	50	3100	95	89	172	218	58	F 07	2,23	1
75	16	65	5000	118	111	196	228	65	F 07	3,43	1
90	16	80	7000	139	126	241	252	89	F 07	6,44	1
110	16	100	11000	165	153	289	276	105	F 07	9,19	1

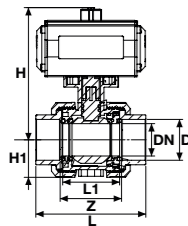

Su İçin
For Water

Düşük Dayanımlı Asit İçin
For Low Strength Acid

Yüksek Dayanımlı Asit İçin
For High Strength Acid

Çap Dia	EPDM Conta Kod EPDM O-Ring Code	Fiyat (Adet) Price (Pcs)	EPDM & PTFE Conta Kod EPDM & PTFE O-Ring Code	Fiyat (Adet) Price (Pcs)	FPM & PTFE Conta Kod FPM & PTFE O-Ring Code	Fiyat (Adet) Price (Pcs)
20	336 00 020 2	106,40 €	336 10 020 2	108,60 €	336 20 020 2	118,60 €
25	336 00 025 2	106,40 €	336 10 025 2	110,30 €	336 20 025 2	120,30 €
32	336 00 032 2	106,40 €	336 10 032 2	112,50 €	336 20 032 2	122,50 €
40	336 00 040 2	113,05 €	336 10 040 2	121,70 €	336 20 040 2	131,70 €
50	336 00 050 2	128,25 €	336 10 050 2	138,30 €	336 20 050 2	158,30 €
63	336 00 063 2	133,00 €	336 10 063 2	144,20 €	336 20 063 2	164,20 €
75	336 00 075 2	181,07 €	336 10 075 2	205,10 €	336 20 075 2	250,10 €
90	336 00 090 2	200,36 €	336 10 090 2	230,40 €	336 20 090 2	275,40 €
110	336 00 110 2	241,21 €	336 10 110 2	272,20 €	336 20 110 2	317,20 €

U-PVC Çift Etkili Pnömatik Aktüatörlü Küresel Vana Çift Taraf Flanş Bağlantılı

U-PVC Pneumatic Actuator True Union Ball Valve Both Sides Flanged Double Effect



Çap Dia	Basınç PN	DN (mm)	kv l/min	Z (mm)	L1 (mm)	L (mm)	H (mm)	H1 (mm)	D1 (mm)	D2 (mm)	n (mm)	ISO 5211 Flanş ISO 5211 Interface	Kg/Adet Kg/Pcs	Koli/Adet Box/Pcs
20	16	15	185	52	45	123	131	27	65	96	14x4	F 03	0,83	1
25	16	20	350	58	49	140	133	31	75	105	14x4	F 03	0,94	1
32	16	25	700	61	54	158	141	33	85	115	14x4	F 05	1,13	1
40	16	32	1000	73	66	186	157	41	100	140	14x4	F 05	2,21	1
50	16	40	1600	82	75	231	182	46	100	150	18x4	F 05	2,57	1
63	16	50	3100	95	89	253	218	58	125	165	18x4	F 07	3,42	1
75	16	65	5000	118	111	291	228	65	145	185	22x4	F 07	4,96	1
90	16	80	7000	139	126	353	252	89	160	200	22x8	F 07	8,40	1
110	16	100	11000	165	153	431	276	105	180	220	24x8	F 07	11,8	1

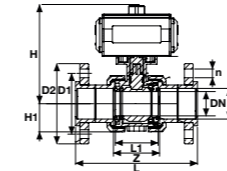

Su İçin
For Water

Düşük Dayanımlı Asit İçin
For Low Strength Acid

Yüksek Dayanımlı Asit İçin
For High Strength Acid

Çap Dia	EPDM Conta Kod EPDM O-Ring Code	Fiyat (Adet) Price (Pcs)	EPDM & PTFE Conta Kod EPDM & PTFE O-Ring Code	Fiyat (Adet) Price (Pcs)	FPM & PTFE Conta Kod FPM & PTFE O-Ring Code	Fiyat (Adet) Price (Pcs)
20	336 30 020 2	117,50 €	336 40 020 2	120,70 €	336 50 020 2	130,70 €
25	336 30 025 2	118,30 €	336 40 025 2	122,40 €	336 50 025 2	132,40 €
32	336 30 032 2	118,30 €	336 40 032 2	124,90 €	336 50 032 2	134,90 €
40	336 30 040 2	125,60 €	336 40 040 2	136,10 €	336 50 040 2	146,10 €
50	336 30 050 2	144,10 €	336 40 050 2	153,10 €	336 50 050 2	173,10 €
63	336 30 063 2	148,70 €	336 40 063 2	160,20 €	336 50 063 2	180,20 €
75	336 30 075 2	205,10 €	336 40 075 2	233,10 €	336 50 075 2	278,10 €
90	336 30 090 2	225,90 €	336 40 090 2	253,40 €	336 50 090 2	298,40 €
110	336 30 110 2	290,90 €	336 40 110 2	341,20 €	336 50 110 2	386,20 €

U-PVC Pnömatik Aktüatörlü Tek Etkili Küresel Vana (Tek Taraf İçten Dışlı)

U-PVC Pneumatic Actuator True Union Ball Valve One Side Female Threaded Single Effect

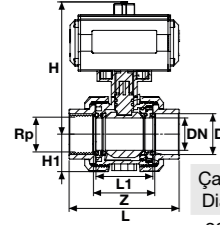

Çap Dia	Rp (Inch)	Basınç PN	DN (mm)	kv l/min	Z (mm)	L1 (mm)	L (mm)	H (mm)	H1 (mm)	ISO 5211 Flanş ISO 5211 Interface	Kg/Adet Kg/Pcs	Koli/Adet Box/Pcs
20	1/2"	16	15	185	52	45	85	131	27	F 03	0,61	1
25	3/4"	16	20	350	58	49	95	133	31	F 03	0,66	1
32	1"	16	25	700	61	54	107	141	33	F 05	0,71	1
40	1 1/4"	16	32	1000	73	66	128	157	41	F 05	1,55	1
50	1 1/2"	16	40	1600	82	75	154	182	46	F 05	1,78	1
63	2"	16	50	3100	95	89	172	218	58	F 07	2,23	1
75	2 1/2"	16	65	5000	118	111	196	228	65	F 07	3,43	1
90	3"	16	80	7000	139	126	241	252	89	F 07	6,44	1
110	4"	16	100	11000	165	153	289	276	105	F 07	9,19	1

Su İçin
For Water

Düşük Dayanımlı Asit İçin
For Low Strength Acid

Yüksek Dayanımlı Asit İçin
For High Strength Acid

Çap Dia	Rp (Inch)	EPDM Conta Kod EPDM O-Ring Code	Fiyat (Adet) Price (Pcs)	EPDM & PTFE Conta Kod EPDM & PTFE O-Ring Code	Fiyat (Adet) Price (Pcs)	FPM & PTFE Conta Kod FPM & PTFE O-Ring Code	Fiyat (Adet) Price (Pcs)
20	1/2"	336 60 020 2	214,60 €	336 70 020 2	219,00 €	336 80 020 2	229,00 €
25	3/4"	336 60 025 2	214,80 €	336 70 025 2	222,60 €	336 80 025 2	232,60 €
32	1"	336 60 032 2	215,40 €	336 70 032 2	227,60 €	336 80 032 2	237,60 €
40	1 1/4"	336 60 040 2	228,70 €	336 70 040 2	245,90 €	336 80 040 2	255,90 €
50	1 1/2"	336 60 050 2	259,10 €	336 70 050 2	279,10 €	336 80 050 2	299,10 €
63	2"	336 60 063 2	268,60 €	336 70 063 2	291,00 €	336 80 063 2	311,00 €
75	2 1/2"	336 60 075 2	366,10 €	336 70 075 2	414,10 €	336 80 075 2	459,10 €
90	3"	336 60 090 2	404,70 €	336 70 090 2	464,70 €	336 80 090 2	509,70 €
110	4"	336 60 110 2	488,40 €	336 70 110 2	550,40 €	336 80 110 2	595,40 €

U-PVC Pnömatik Aktüatörlü Tek Etkili Küresel Vana (Çift Taraf İçten Dışlı)

U-PVC Pneumatic Actuator True Union Ball Valve Both Sides Female Threaded Single Effect

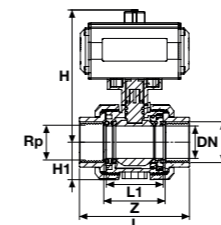

Rp (Inch)	Basınç PN	DN (mm)	kv l/min	Z (mm)	L1 (mm)	L (mm)	H (mm)	H1 (mm)	ISO 5211 Flanş ISO 5211 Interface	Kg/Adet Kg/Pcs	Koli/Adet Box/Pcs
1/2"	16	15	185	52	45	85	131	27	F 03	0,61	1
3/4"	16	20	350	58	49	95	133	31	F 03	0,66	1
1"	16	25	700	61	54	107	141	33	F 05	0,71	1
1 1/4"	16	32	1000	73	66	128	157	41	F 05	1,55	1
1 1/2"	16	40	1600	82	75	154	182	46	F 05	1,78	1
2"	16	50	3100	95	89	172	218	58	F 07	2,23	1
2 1/2"	16	65	5000	118	111	196	228	65	F 07	3,43	1
3"	16	80	7000	139	126	241	252	89	F 07	6,44	1
4"	16	100	11000	165	153	289	276	105	F 07	9,19	1

Su İçin
For Water

Düşük Dayanımlı Asit İçin
For Low Strength Acid

Yüksek Dayanımlı Asit İçin
For High Strength Acid

Rp (Inch)	EPDM Conta Kod EPDM O-Ring Code	Fiyat (Adet) Price (Pcs)	EPDM & PTFE Conta Kod EPDM & PTFE O-Ring Code	Fiyat (Adet) Price (Pcs)	FPM & PTFE Conta Kod FPM & PTFE O-Ring Code	Fiyat (Adet) Price (Pcs)
1/2"	337 30 020 2	216,40 €	337 40 020 2	220,80 €	337 50 020 2	230,80 €
3/4"	337 30 025 2	216,60 €	337 40 025 2	224,20 €	337 50 025 2	234,20 €
1"	337 30 032 2	217,60 €	337 40 032 2	228,20 €	337 50 032 2	238,20 €
1 1/4"	337 30 040 2	230,90 €	337 40 040 2	246,50 €	337 50 040 2	256,50 €
1 1/2"	337 30 050 2	261,70 €	337 40 050 2	281,70 €	337 50 050 2	301,70 €
2"	337 30 063 2	271,20 €	337 40 063 2	293,60 €	337 50 063 2	313,60 €
2 1/2"	337 30 075 2	370,10 €	337 40 075 2	418,10 €	337 50 075 2	463,10 €
3"	337 30 090 2	408,70 €	337 40 090 2	468,70 €	337 50 090 2	531,70 €
4"	337 30 110 2	494,40 €	337 40 110 2	558,40 €	337 50 110 2	603,40 €

U-PVC Pnömatik Aktüatörlü Çift Etkili Küresel Vana (Tek Taraf İçten Dışlı)

U-PVC Pneumatic Actuator True Union Ball Valve One Side Female Threaded Double Effect

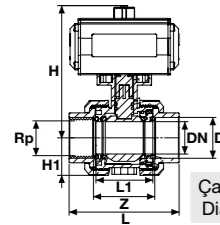

Çap Dia	Rp (Inch)	Basınç PN	DN (mm)	kv l/min	Z (mm)	L1 (mm)	L (mm)	H (mm)	H1 (mm)	ISO 5211 Flanş ISO 5211 Interface	Kg/Adet Kg/Pcs	Koli/Adet Box/Pcs
20	1/2"	16	15	185	52	45	85	131	27	F 03	0,61	1
25	3/4"	16	20	350	58	49	95	133	31	F 03	0,66	1
32	1"	16	25	700	61	54	107	141	33	F 05	0,71	1
40	1 1/4"	16	32	1000	73	66	128	157	41	F 05	1,55	1
50	1 1/2"	16	40	1600	82	75	154	182	46	F 05	1,78	1
63	2"	16	50	3100	95	89	172	218	58	F 07	2,23	1
75	2 1/2"	16	65	5000	118	111	196	228	65	F 07	3,43	1
90	3"	16	80	7000	139	126	241	252	89	F 07	6,44	1
110	4"	16	100	11000	165	153	289	276	105	F 07	9,19	1

Su İçin
For Water

Düşük Dayanımlı Asit İçin
For Low Strength Acid

Yüksek Dayanımlı Asit İçin
For High Strength Acid

Çap Dia	Rp (Inch)	EPDM Conta Kod EPDM O-Ring Code	Fiyat (Adet) Price (Pcs)	EPDM & PTFE Conta Kod EPDM & PTFE O-Ring Code	Fiyat (Adet) Price (Pcs)	FPM & PTFE Conta Kod FPM & PTFE O-Ring Code	Fiyat (Adet) Price (Pcs)
20	1/2"	339 00 020 2	107,30 €	339 10 020 2	109,50 €	339 20 020 2	119,50 €
25	3/4"	339 00 025 2	107,40 €	339 10 025 2	111,30 €	339 20 025 2	121,30 €
32	1"	339 00 032 2	107,70 €	339 10 032 2	113,80 €	339 20 032 2	123,80 €
40	1 1/4"	339 00 040 2	114,40 €	339 10 040 2	123,00 €	339 20 040 2	133,00 €
50	1 1/2"	339 00 050 2	129,60 €	339 10 050 2	139,60 €	339 20 050 2	159,60 €
63	2"	339 00 063 2	134,30 €	339 10 063 2	145,50 €	339 20 063 2	165,50 €
75	2 1/2"	339 00 075 2	183,10 €	339 10 075 2	207,10 €	339 20 075 2	252,10 €
90	3"	339 00 090 2	202,40 €	339 10 090 2	232,40 €	339 20 090 2	277,40 €
110	4"	339 00 110 2	244,20 €	339 10 110 2	275,20 €	339 20 110 2	320,20 €

U-PVC Pnömatik Aktüatörlü Çift Etkili Küresel Vana (Çift Taraf İçten Dışlı)

U-PVC Pneumatic Actuator True Union Ball Valve Both Sides Female Threaded Double Effect

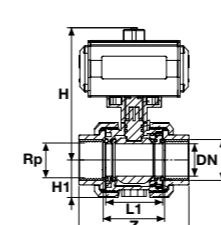

Rp (Inch)	Basınç PN	DN (mm)	kv l/min	Z (mm)	L1 (mm)	L (mm)	H (mm)	H1 (mm)	ISO 5211 Flanş ISO 5211 Interface	Kg/Adet Kg/Pcs	Koli/Adet Box/Pcs
1/2"	16	15	185	52	45	85	131	27	F 03	0,61	1
3/4"	16	20	350	58	49	95	133	31	F 03	0,66	1
1"	16	25	700	61	54	107	141	33	F 05	0,71	1
1 1/4"	16	32	1000	73	66	128	157	41	F 05	1,55	1
1 1/2"	16	40	1600	82	75	154	182	46	F 05	1,78	1
2"	16	50	3100	95	89	172	218	58	F 07	2,23	1
2 1/2"	16	65	5000	118	111	196	228	65	F 07	3,43	1
3"	16	80	7000	139	126	241	252	89	F 07	6,44	1
4"	16	100	11000	165	153	289	276	105	F 07	9,19	1

Su İçin
For Water

Düşük Dayanımlı Asit İçin
For Low Strength Acid

Yüksek Dayanımlı Asit İçin
For High Strength Acid

Rp (Inch)	EPDM Conta Kod EPDM O-Ring Code	Fiyat (Adet) Price (Pcs)	EPDM & PTFE Conta Kod EPDM & PTFE O-Ring Code	Fiyat (Adet) Price (Pcs)	FPM & PTFE Conta Kod FPM & PTFE O-Ring Code	Fiyat (Adet) Price (Pcs)
1/2"	337 60 020 2	108,20 €	337 70 020 2	110,40 €	337 80 020 2	120,40 €
3/4"	337 60 025 2	108,30 €	337 70 025 2	112,10 €	337 80 025 2	122,10 €
1"	337 60 032 2	108,80 €	337 70 032 2	114,10 €	337 80 032 2	124,10 €
1 1/4"	337 60 040 2	115,50 €	337 70 040 2	123,30 €	337 80 040 2	133,30 €
1 1/2"	337 60 050 2	130,90 €	337 70 050 2	140,90 €	337 80 050 2	160,90 €
2"	337 60 063 2	135,60 €	337 70 063 2	146,80 €	337 80 063 2	166,80 €
2 1/2"	337 60 075 2	185,10 €	337 70 075 2	209,10 €	337 80 075 2	254,10 €
3"	337 60 090 2	204,40 €	337 70 090 2	234,40 €	337 80 090 2	279,40 €
4"	337 60 110 2	247,20 €	337 70 110 2	279,20 €	337 80 110 2	324,20 €

Not / Note

HDPE

BORU

PIPE

ÜRETİM STANDARDI**PRODUCTION STANDARD****TS EN 12201-2****ÇAP / SIZE Ø20 - Ø630**

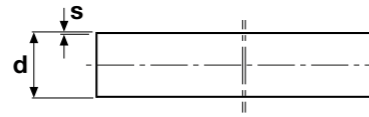

PE 100 Boru SDR 41 - PN4

PE 100 Pipe SDR 41 - PN4

Çap Dia	Kod / Code 6 m	Fiyat (m) Price (m)	Kod / Code 12 m	Fiyat (m) Price (m)	s (mm) Et Kalınlığı Wall thickness	Kg / Mt
90	900 04 090 2	⌚	12900 04 090 2	⌚	2,3	0,643
110	900 04 110 2	⌚	12900 04 110 2	⌚	2,7	0,943
125	900 04 125 2	⌚	12900 04 125 2	⌚	3,1	1,23
140	900 04 140 2	⌚	12900 04 140 2	⌚	3,5	1,54
160	900 04 160 2	⌚	12900 04 160 2	⌚	4	2
180	900 04 180 2	⌚	12900 04 180 2	⌚	4,4	2,49
200	900 04 200 2	⌚	12900 04 200 2	⌚	4,9	3,05
225	900 04 225 2	⌚	12900 04 225 2	⌚	5,5	3,86
250	900 04 250 2	⌚	12900 04 250 2	⌚	6,2	4,83
280	900 04 280 2	⌚	12900 04 280 2	⌚	6,9	5,98
315	900 04 315 2	⌚	12900 04 315 2	⌚	7,7	7,52
355	900 04 355 2	⌚	12900 04 355 2	⌚	8,7	9,55
400	900 04 400 2	⌚	12900 04 400 2	⌚	9,8	12,1
450	900 04 450 2	⌚	12900 04 450 2	⌚	11	1,3
500	900 04 500 2	⌚	12900 04 500 2	⌚	12,3	19
560	900 04 560 2	⌚	12900 04 560 2	⌚	13,7	23,6
630	900 04 630 2	⌚	12900 04 630 2	⌚	15,4	29,9

PE 100 Boru SDR 33 - PN5

PE 100 Pipe SDR 33 - PN5

Çap Dia	Kod / Code 6 m	Fiyat (m) Price (m)	Kod / Code 12 m	Fiyat (m) Price (m)	s (mm) Et Kalınlığı Wall thickness	Kg / Mt
63	900 33 063 2	⌚	12900 33 063 2	⌚	2	0,399
75	900 33 075 2	⌚	12900 33 075 2	⌚	2,3	0,551
90	900 33 090 2	⌚	12900 33 090 2	⌚	2,8	0,791
110	900 33 110 2	⌚	12900 33 110 2	⌚	3,4	1,17
125	900 33 125 2	⌚	12900 33 125 2	⌚	3,9	1,51
140	900 33 140 2	⌚	12900 33 140 2	⌚	4,3	1,88
160	900 33 160 2	⌚	12900 33 160 2	⌚	4,9	2,42
180	900 33 180 2	⌚	12900 33 180 2	⌚	5,5	3,07
200	900 33 200 2	⌚	12900 33 200 2	⌚	6,2	3,84
225	900 33 225 2	⌚	12900 33 225 2	⌚	6,9	4,77
250	900 33 250 2	⌚	12900 33 250 2	⌚	7,7	5,92
280	900 33 280 2	⌚	12900 33 280 2	⌚	8,6	7,4
315	900 33 315 2	⌚	12900 33 315 2	⌚	9,7	9,37
355	900 33 355 2	⌚	12900 33 355 2	⌚	10,9	11,8
400	900 33 400 2	⌚	12900 33 400 2	⌚	12,3	15,1
450	900 33 450 2	⌚	12900 33 450 2	⌚	13,8	19
500	900 33 500 2	⌚	12900 33 500 2	⌚	15,3	23,4
560	900 33 560 2	⌚	12900 33 560 2	⌚	17,2	29,4
630	900 33 630 2	⌚	12900 33 630 2	⌚	19,3	27,1

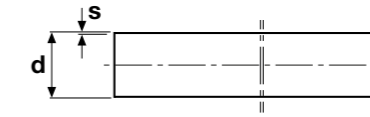
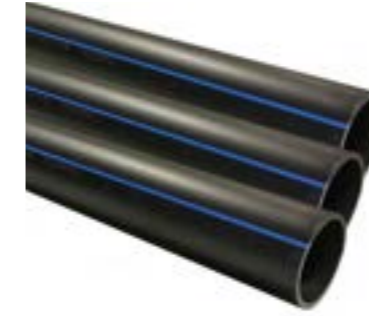

PE 100 Boru SDR 26 - PN6

PE 100 Pipe SDR 26 - PN6

Çap Dia	Kod / Code 6 m	Fiyat (m) Price (m)	Kod / Code 12 m	Fiyat (m) Price (m)	s (mm) Et Kalınlığı Wall thickness	Kg / Mt
50	906 00 050 2	⌚	906 12 050 2	⌚	2	0,314
63	906 00 063 2	⌚	906 12 063 2	⌚	2,5	0,494
75	906 00 075 2	⌚	906 12 075 2	⌚	2,9	0,675
90	906 00 090 2	⌚	906 12 090 2	⌚	3,5	0,978
110	906 00 110 2	⌚	906 12 110 2	⌚	4,2	1,43
125	906 00 125 2	⌚	906 12 125 2	⌚	4,8	1,84
140	906 00 140 2	⌚	906 12 140 2	⌚	5,4	2,32
160	906 00 160 2	⌚	906 12 160 2	⌚	6,2	3,04
180	906 00 180 2	⌚	906 12 180 2	⌚	6,9	3,79
200	906 00 200 2	⌚	906 12 200 2	⌚	7,7	4,69
225	906 00 225 2	⌚	906 12 225 2	⌚	8,6	5,89
250	906 00 250 2	⌚	906 12 250 2	⌚	9,6	7,3
280	906 00 280 2	⌚	906 12 280 2	⌚	10,7	9,1
315	906 00 315 2	⌚	906 12 315 2	⌚	12,1	11,6
355	906 00 355 2	⌚	906 12 355 2	⌚	13,6	14,6
400	906 00 400 2	⌚	906 12 400 2	⌚	15,3	18,6
450	906 00 450 2	⌚	906 12 450 2	⌚	17,2	23,5
500	906 00 500 2	⌚	906 12 500 2	⌚	19,1	28,9
560	906 00 560 2	⌚	906 12 560 2	⌚	21,4	36,2
630	906 00 630 2	⌚	906 12 630 2	⌚	24,1	45,9

PE 100 Boru SDR 21 - PN8

PE 100 Pipe SDR 21 - PN8

Çap Dia	Kod / Code 6 m	Fiyat (m) Price (m)	Kod / Code 12 m	Fiyat (m) Price (m)	s (mm) Et Kalınlığı Wall thickness	Kg / Mt
40	900 08 040 2	⌚	900 21 040 2	⌚	2	0,239
50	900 08 050 2	⌚	900 21 050 2	⌚	2,4	0,359
63	900 08 063 2	⌚	900 21 063 2	⌚	3	0,565
75	900 08 075 2	⌚	900 21 075 2	⌚	3,6	0,807
90	900 08 090 2	⌚	900 21 090 2	⌚	4,3	1,16
110	900 08 110 2	⌚	900 21 110 2	⌚	5,3	1,74
125	900 08 125 2	⌚	900 21 125 2	⌚	6	2,2
140	900 08 140 2	⌚	900 21 140 2	⌚	6,7	2,8
160	900 08 160 2	⌚	900 21 160 2	⌚	7,7	3,68
180	900 08 180 2	⌚	900 21 180 2	⌚	8,6	4,63
200	900 08 200 2	⌚	900 21 200 2	⌚	9,6	5,73
225	900 08 225 2	⌚	900 21 225 2	⌚	10,8	7,26
250	900 08 250 2	⌚	900 21 250 2	⌚	11,9	8,9
280	900 08 280 2	⌚	900 21 280 2	⌚	13,4	11,22
315	900 08 315 2	⌚	900 21 315 2	⌚	15	14,13
355	900 08 355 2	⌚	900 21 355 2	⌚	16,9	17,94
400	900 08 400 2	⌚	900 21 400 2	⌚	19,1	22,84
450	900 08 450 2	⌚	900 21 450 2	⌚	21,5	28,9
500	900 08 500 2	⌚	900 21 500 2	⌚	23,9	35,7
560	900 08 560 2	⌚	900 21 560 2	⌚	26,7	44,7
630	900 08 630 2	⌚	900 21 630 2	⌚	30	56,5

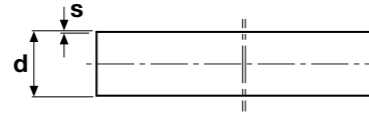
PE 100 Boru SDR 7,4 - PN25
 PE 100 Pipe SDR 7,4 - PN25

Çap Dia	Kod / Code 6 m	Fiyat (m) Price (m)	Kod / Code 12 m	Fiyat (m) Price (m)	s (mm) Et Kalınlığı Wall thickness	Kg / Mt
20	900 25 020 2	⌚	12900 25 020 2	⌚	3,0	0,154
25	900 25 025 2	⌚	12900 25 025 2	⌚	3,5	0,24
32	900 25 032 2	⌚	12900 25 032 2	⌚	4,4	0,386
40	900 25 040 2	⌚	12900 25 040 2	⌚	5,5	0,6
50	900 25 050 2	⌚	12900 25 050 2	⌚	6,9	0,936
63	900 25 063 2	⌚	12900 25 063 2	⌚	8,6	1,47
75	900 25 075 2	⌚	12900 25 075 2	⌚	10,3	2,09
90	900 25 090 2	⌚	12900 25 090 2	⌚	12,3	3
110	900 25 110 2	⌚	12900 25 110 2	⌚	15,1	4,49
125	900 25 125 2	⌚	12900 25 125 2	⌚	17,1	5,77
140	900 25 140 2	⌚	12900 25 140 2	⌚	19,2	7,25
160	900 25 160 2	⌚	12900 25 160 2	⌚	21,9	9,44
180	900 25 180 2	⌚	12900 25 180 2	⌚	24,6	11,9
200	900 25 200 2	⌚	12900 25 200 2	⌚	27,4	14,8
225	900 25 225 2	⌚	12900 25 225 2	⌚	30,8	18,6
250	900 25 250 2	⌚	12900 25 250 2	⌚	34,2	23
280	900 25 280 2	⌚	12900 25 280 2	⌚	38,3	28,9
315	900 25 315 2	⌚	12900 25 315 2	⌚	43,1	36,5
355	900 25 355 2	⌚	12900 25 355 2	⌚	48,5	46,3
400	900 25 400 2	⌚	12900 25 400 2	⌚	54,7	58,8
450	900 25 450 2	⌚	12900 25 450 2	⌚	61,5	74,4
500	900 25 500 2	⌚	12900 25 500 2	⌚	68,3	91,8

PE 100 Boru SDR 6 - PN32
 PE 100 Pipe SDR 6 - PN32

Çap Dia	Kod / Code 6 m	Fiyat (m) Price (m)	Kod / Code 12 m	Fiyat (m) Price (m)	s (mm) Et Kalınlığı Wall thickness	Kg / Mt
20	900 10 020 1	⌚	12900 10 020 1	⌚	3,4	0,18
25	900 10 025 1	⌚	12900 10 025 1	⌚	4,2	0,278
32	900 10 032 1	⌚	12900 10 032 1	⌚	5,4	0,454
40	900 10 040 1	⌚	12900 10 040 1	⌚	6,7	0,701
50	900 10 050 1	⌚	12900 10 050 1	⌚	8,3	1,09
63	900 10 063 1	⌚	12900 10 063 1	⌚	10,5	1,73
75	900 10 075 1	⌚	12900 10 075 1	⌚	12,5	2,44
90	900 10 090 1	⌚	12900 10 090 1	⌚	15,0	3,51
110	900 10 110 1	⌚	12900 10 110 1	⌚	18,3	5,24
125	900 10 125 1	⌚	12900 10 125 1	⌚	20,8	6,75
140	900 10 140 1	⌚	12900 10 140 1	⌚	23,3	8,47
160	900 10 160 1	⌚	12900 10 160 1	⌚	26,6	11
180	900 10 180 1	⌚	12900 10 180 1	⌚	29,9	14
200	900 10 200 1	⌚	12900 10 200 1	⌚	33,2	17,2
225	900 10 225 1	⌚	12900 10 225 1	⌚	37,4	21,8
250	900 10 250 1	⌚	12900 10 250 1	⌚	41,5	27
280	900 10 280 1	⌚	12900 10 280 1	⌚	46,5	33,8
315	900 10 315 1	⌚	12900 10 315 1	⌚	52,3	42,7
355	900 10 355 1	⌚	12900 10 355 1	⌚	59,0	54,3
400	900 10 400 1	⌚	12900 10 400 1	⌚	66,5	68,9

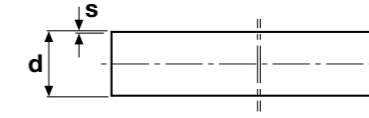
PE 100 Kangal Boru SDR 41 - PN4
 PE 100 Pipe SDR 41 - PN4

Çap Dia	Kod Code	Fiyat (m) Price (m)	s (mm) Et Kalınlığı Wall thickness	Kg / Mt
90	950 04 090	⌚	2,3	0,643
110	950 04 110	⌚	2,7	0,943

PE 100 Kangal Boru SDR 33 - PN5
 PE 100 Coil Pipe SDR 33 - PN5

Çap Dia	Kod Code	Fiyat (m) Price (m)	s (mm) Et Kalınlığı Wall thickness	Kg / Mt
63	950 05 063	⌚	2,0	0,399
75	950 05 075	⌚	2,3	0,551
90	950 05 090	⌚	2,8	0,791
110	950 05 110	⌚	3,4	1,17

PE 100 Kangal Boru SDR 26 - PN6
 PE 100 Coil Pipe SDR 26 - PN6

Çap Dia	Kod Code	Fiyat (m) Price (m)	s (mm) Et Kalınlığı Wall thickness	Kg / Mt
50	950 06 050	⌚	2,0	0,314
63	950 06 063	⌚	2,5	0,494
75	950 06 075	⌚	2,9	0,675
90	950 06 090	⌚	3,5	0,978
110	950 06 110	⌚	4,2	1,43

PE 100 Kangal Boru SDR 21 - PN8
 PE 100 Coil Pipe SDR 21 - PN8

Çap Dia	Kod Code	Fiyat (m) Price (m)	s (mm) Et Kalınlığı Wall thickness	Kg / Mt
40	950 08 040	⌚	2	0,239
50	950 08 050	⌚	2,4	0,359
63	950 08 063	⌚	3	0,565
75	950 08 075	⌚	3,6	0,807
90	950 08 090	⌚	4,3	1,16
110	950 08 110	⌚	5,3	1,74

PE 100 Kangal Boru SDR 17 - PN10
 PE 100 Coil Pipe SDR 17 - PN10

Çap Dia	Kod Code	Fiyat (m) Price (m)	s (mm) Et Kalınlığı Wall thickness	Kg / Mt
32	950 00 032	⌚	2	0,187
40	950 00 040	⌚	2,4	0,295
50	950 00 050	⌚	3	0,453
63	950 00 063	⌚	3,8	0,721
75	950 00 075	⌚	4,5	1,02
90	950 00 090	⌚	5,4	1,46
110	950 00 110	⌚	6,6	2,17



PE 100 Kangal Boru SDR 13,6 - PN12,5

PE 100 Coil Pipe SDR 13,6 - PN12,5

Çap Dia	Kod Code	Fiyat (m) Price (m)	s (mm) Et Kalınlığı Wall thickness	Kg / Mt	Kangal 100 m
25	950 12 025	①	2	0,152	
32	950 12 032	①	2,4	0,232	
40	950 12 040	①	3	0,356	
50	950 12 050	①	3,7	0,549	
63	950 12 063	①	4,7	0,873	
75	950 12 075	①	5,6	1,24	
90	950 12 090	①	6,7	1,77	
110	950 12 110	①	8,1	2,62	

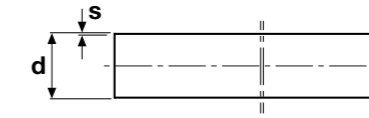

PE 100 Kangal Boru SDR 7,4 - PN25

PE 100 Coil Pipe SDR 7,4 - PN25

Çap Dia	Kod Code	Fiyat (m) Price (m)	s (mm) Et Kalınlığı Wall thickness	Kg / Mt	Kangal 100 m
20	950 25 020	①	3	0,154	
25	950 25 025	①	3,5	0,24	
32	950 25 032	①	4,4	0,386	
40	950 25 040	①	5,5	0,6	
50	950 25 050	①	6,9	0,936	
63	950 25 063	①	8,6	1,47	
75	950 25 075	①	10,3	2,09	
90	950 25 090	①	12,3	3	
110	950 25 110	①	15,1	4,49	

PE 100 Kangal Boru SDR 11 - PN16

PE 100 Coil Pipe SDR 11 - PN16

Çap Dia	Kod Code	Fiyat (m) Price (m)	s (mm) Et Kalınlığı Wall thickness	Kg / Mt	Kangal 100 m
20	950 20 020	①	2	0,112	
25	950 20 025	①	2,3	0,171	
32	950 20 032	①	3	0,272	
40	950 20 040	①	3,7	0,43	
50	950 20 050	①	4,6	0,666	
63	950 20 063	①	5,8	1,05	
75	950 20 075	①	6,8	1,47	
90	950 20 090	①	8,2	2,12	
110	950 20 110	①	10	3,14	

PE 100 Kangal Boru SDR 6 - PN32

PE 100 Coil Pipe SDR 6 - PN32

Çap Dia	Kod Code	Fiyat (m) Price (m)	s (mm) Et Kalınlığı Wall thickness	Kg / Mt	Kangal 100 m
20	950 32 020	①	3,4	0,18	
25	950 32 025	①	4,2	0,278	
32	950 32 032	①	5,4	0,454	
40	950 32 040	①	6,7	0,701	
50	950 32 050	①	8,3	1,09	
63	950 32 063	①	10,5	1,73	
75	950 32 075	①	12,5	2,44	
90	950 32 090	①	15	3,51	
110	950 32 110	①	18,3	5,24	

PE 100 Kangal Boru SDR 9 - PN20

PE 100 Coil Pipe SDR 9 - PN20

Çap Dia	Kod Code	Fiyat (m) Price (m)	s (mm) Et Kalınlığı Wall thickness	Kg / Mt	Kangal 100 m
20	950 30 020	①	2,3	0,133	
25	950 30 025	①	3	0,22	
32	950 30 032	①	3,6	0,327	
40	950 30 040	①	4,5	0,509	
50	950 30 050	①	5,6	0,788	
63	950 30 063	①	7,1	1,26	
75	950 30 075	①	8,4	1,76	
90	950 30 090	①	10,1	2,54	
110	950 30 110	①	12,3	3,78	

Not / Note

HDPE

VANA

VALVE

ÜRETİM STANDARDI

PRODUCTION STANDARD

TS EN 12201-4

ÇAP / SIZE Ø20 - Ø400



Not / Note

HDPE

EF EK PARÇALAR EF FITTINGS

ÜRETİM STANDARDI

PRODUCTION STANDARD

TS EN 12201-3 +A1

ÇAP / SIZE Ø20 - Ø400



Not / Note

HDPE

SPIGOT EK PARÇALAR SPIGOT FITTINGS

ÜRETİM STANDARDI

PRODUCTION STANDARD

TS EN 12201-3 +A1

ÇAP / SIZE Ø20 - Ø630

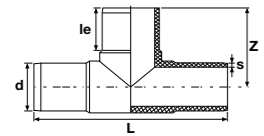

Eşit- Te Spigot Enjeksiyon
 Equal-Tee Spigot Injection

PE100 SDR11

Çap Dia	Basınç PN	Kod Code	Fiyat (Adet) Price (Pcs)	Kg /Adet Kg/Pcs	Koli/Adet Box/Pcs	le (mm)	L (mm)	Z (mm)	s (mm)
20	16	900 40 020 2	7,59 €	0,038	50	41	148	74	3,0
25	16	900 40 025 2	8,91 €	0,054	40	41	158	78	3,0
32	16	900 40 032 2	9,49 €	0,074	30	44	170	86	3,0
40	16	900 40 040 2	10,35 €	0,134	50	49	188	90	3,7
50	16	900 40 050 2	10,58 €	0,242	47	55	225	109	4,6
63	16	900 40 063 2	9,60 €	0,384	36	63	225	117	5,8
75	16	900 40 075 2	15,64 €	0,560	22	70	268	134	6,8
90	16	900 40 090 2	20,36 €	0,892	14	79	290	142	8,2
110	16	900 40 110 2	27,95 €	1,580	14	82	332	166	10,0
125	16	900 40 125 2	45,60 €	2,204	8	87	362	181	11,4
140	16	900 40 140 2	82,23 €	2,751	6	92	378	189	12,7
160	16	900 40 160 2	83,61 €	4,130	4	98	422	211	14,6
180	16	900 40 180 2	129,61 €	5,658	3	105	455	225	16,4
200	16	900 40 200 2	151,86 €	7,490	2	112	481	240	18,2
225	16	900 40 225 2	189,75 €	10,126	2	120	527	263	20,5
250	16	900 40 250 2	296,07 €	13,768	2	130	590	295	22,7
280	16	900 40 280 2	485,88 €	21,564	1	139	690	345	25,4
315	16	900 40 315 2	607,43 €	27,066	1	150	710	346	28,6
355	16	900 40 355 2	1.042,25 €	36,830	1	164	789	394	32,3
400	16	900 40 400 2	1.808,84 €	55,760	1	179	877	439	36,4

PE100 SDR17

Çap Dia	Basınç PN	Kod Code	Fiyat (Adet) Price (Pcs)	Kg /Adet Kg/Pcs	Koli/Adet Box/Pcs	le (mm)	L (mm)	Z (mm)	s (mm)
63	10	900 40 063 1	8,68 €	0,310	36	63	225	114	3,8
75	10	900 40 075 1	14,09 €	0,434	22	70	261	130	4,5
90	10	900 40 090 1	18,40 €	0,676	14	79	290	142	5,4
110	10	900 40 110 1	25,13 €	1,232	14	82	327	162	6,6
125	10	900 40 125 1	41,06 €	1,626	8	87	356	178	7,4
140	10	900 40 140 1	73,95 €	2,028	6	92	378	189	8,3
160	10	900 40 160 1	75,21 €	3,076	4	98	417	208	9,5
180	10	900 40 180 1	116,67 €	4,140	3	105	458	225	10,7
200	10	900 40 200 1	136,62 €	5,222	2	112	481	236	11,9
225	10	900 40 225 1	170,78 €	7,350	2	120	527	260	13,4
250	10	900 40 250 1	266,46 €	9,858	2	130	590	292	14,8
280	10	900 40 280 1	437,23 €	15,856	1	139	690	340	16,6
315	10	900 40 315 1	546,71 €	19,200	1	150	712	352	18,7
355	10	900 40 355 1	937,94 €	27,280	1	164	789	394	21,1
400	10	900 40 400 1	1.627,88 €	38,250	1	179	877	439	23,7

45° Çatal Te Enjeksiyon
 45° Wye Tee Spigot Injection

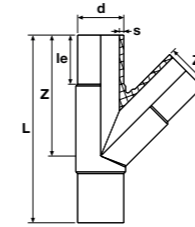
PE 100 SDR11

Çap Dia	Basınç PN	Kod Code	Fiyat (Adet) Price (Pcs)	Kg /Adet Kg/Pcs	Koli/Adet Box/Pcs	L (mm)	le (mm)	Z (mm)	s (mm)
63	16	900 41 063 2	14,43 €	0,474	22	254	63	164	5,8
75	16	900 41 075 2	23,46 €	0,693	20	284	70	185	6,8
90	16	900 41 090 2	30,59 €	1,150	11	321	79	213	8,2
110	16	900 41 110 2	41,86 €	1,580	9	376	82	251	10,0
125	16	900 41 125 2	68,43 €	1,964	5	412	87	277	11,4
160	16	900 41 160 2	167,15 €	2,860	30	531	98	356	14,6
180	16	900 41 180 2	259,27 €	8,590	20	578	105	394	16,4
200	16	900 41 200 2	303,60 €	11,350	13	630	112	430	18,2
225	16	900 41 225 2	379,56 €	15,790	10	692	120	475	20,5
250	16	900 41 250 2	592,19 €	20,130	8	729	129	507	22,7

PE 100 SDR17

Çap Dia	Basınç PN	Kod Code	Fiyat (Adet) Price (Pcs)	Kg /Adet Kg/Pcs	Koli/Adet Box/Pcs	L (mm)	le (mm)	Z (mm)	s (mm)
63	10	900 41 063 1	13,00 €	0,474	22	254	63	164	3,8
75	10	900 41 075 1	21,10 €	0,693	20	284	70	185	4,5
90	10	900 41 090 1	27,49 €	1,150	11	321	79	213	5,4
110	10	900 41 110 1	37,66 €	1,580	9	376	82	251	6,6
125	10	900 41 125 1	61,58 €	1,964	5	412	87	277	7,4
160	10	900 41 160 1	150,42 €	2,860	30	531	98	356	9,5
180	10	900 41 180 1	233,39 €	8,590	20	578	105	394	10,7
200	10	900 41 200 1	273,30 €	11,350	13	630	112	430	11,9
225	10	900 41 225 1	341,55 €	15,790	10	692	120	475	13,4
250	10	900 41 250 1	532,97 €	20,130	8	729	129	507	14,8

PP Kaplı Çelik Flanş
PP Coated Steel Flange

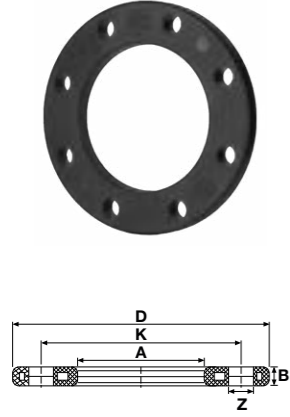

PE100 SDR11 PN 16

Çap Dia	Basınç PN	Kod Code	Fiyat (Adet) Price (Pcs)	Kg /Adet Kg/Pcs	Koli/Adet Box/Pcs	D (mm)	A (mm)	K (mm)	B (mm)	L (mm)	Civata (mm)	Delik Adedi (mm)
20	16	901 00 020 2	13,11 €	2,323	85	95	28	65	12	14	M12	4
25	16	901 00 025 2	13,11 €	0,288	68	105	34	75	12	14	M12	4
32	16	901 00 032 2	16,68 €	0,544	52	115	42	85	16	14	M12	4
40	16	901 00 040 2	19,26 €	0,836	20	140	51	100	16	18	M16	4
50	16	901 00 050 2	23,69 €	0,902	15	150	62	110	18	18	M16	4
63	16	901 00 063 2	29,38 €	1,074	15	165	78	125	18	18	M16	4
75	16	901 00 075 2	32,72 €	1,368	15	188	92	145	18	18	M16	4
90	16	901 00 090 2	41,46 €	1,516	10	204	108	160	20	18	M16	8
110	16	901 00 110 2	54,57 €	1,960	10	224	128	180	20	18	M16	8
125	16	901 00 125 2	54,57 €	1,938	10	224	135	180	20	18	M16	8
140	16	901 00 140 2	65,32 €	2,866	6	252	158	210	24	18	M16	8
160	16	901 00 160 2	84,41 €	3,576	6	285	178	240	24	22	M20	8
180	16	901 00 180 2	84,41 €	3,298	6	285	188	240	24	22	M20	8
200	16	901 00 200 2	128,46 €	5,032	4	340	235	295	27	22	M20	12
225	16	901 00 225 2	128,46 €	4,900	4	340	238	295	27	22	M20	12
250	16	901 00 250 2	190,44 €	10,182	2	419	288	355	32	26	M24	12
280	16	901 00 280 2	190,44 €	9,860	2	419	294	350	32	26	M24	12
315	16	901 00 315 2	288,71 €	13,150	2	478	338	410	34	26	M24	12
355	16	901 00 355 2	582,19 €	22,200	1	532	376	470	42	26	M24	16
400	16	901 00 400 2	636,81 €	26,214	1	592	430	525	46	30	M27	16

PE100 SDR17 PN 10

Çap Dia	Basınç PN	Kod Code	Fiyat (Adet) Price (Pcs)	Kg /Adet Kg/Pcs	Koli/Adet Box/Pcs	D (mm)	A (mm)	K (mm)	B (mm)	L (mm)	Civata (mm)	Delik Adedi (mm)
200	16	901 00 200 1	134,78 €	5,318	4	340	235	295	27	22	M20	8
225	16	901 00 225 1	134,78 €	5,500	4	340	238	295	27	22	M20	8
250	16	901 00 250 1	253,52 €	6,962	2	395	288	350	30	22	M20	12
280	16	901 00 280 1	253,52 €	7,092	2	395	294	350	30	22	M20	12
315	16	901 00 315 1	372,14 €	9,428	2	445	338	400	34	22	M20	12
355	16	901 00 355 1	637,68 €	19,285	1	514	376	460	40	22	M20	16
400	16	901 00 400 1	751,76 €	21,370	1	571	430	515	40	26	M24	16

PE Pirinç Metal Geçiş Adaptörü Dış Dişli
PE Brass Metal Transition Adaptor Male Threaded

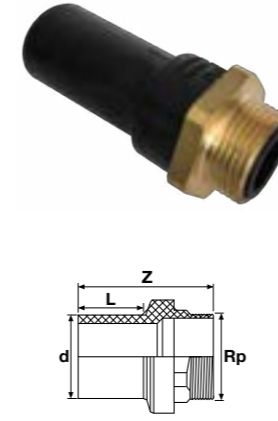

Çap Dia	Basınç PN	Kod Code	Fiyat (Adet) Price (Pcs)	Kg /Adet Kg/Pcs	Koli/Ad. Box/Pcs	L (mm)	Z (mm)
20x1/2"	16	901 006 20 2	16,67 €	0,080	100	45	83
25x3/4"	16	901 006 25 2	16,67 €	0,104	100	45	83
32x1"	16	901 006 32 2	22,13 €	0,175	50	47	96
40x1 1/4"	16	901 006 40 2	30,36 €	0,350	35	56	118
50x1 1/2"	16	901 006 50 2	36,80 €	0,360	32	56	119
63x 2"	16	901 006 63 2	46,40 €	0,605	10	69	137
75x2 1/2"	16	901 006 75 2	85,27 €	0,810	5	80	155
90x3"	16	901 006 90 2	110,68 €	1,200	4	83	165
110x4"	16	901 06 110 2	149,50 €	1,810	2	85	168

PE Pirinç Metal Geçiş Adaptörü İç Dişli
PE Brass Metal Transition Adaptor Female Threaded

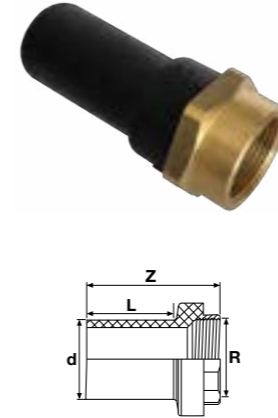

Çap Dia	Basınç PN	Kod Code	Fiyat (Adet) Price (Pcs)	Kg /Adet Kg/Pcs	Koli/Ad. Box/Pcs	L (mm)	Z (mm)
20x1/2"	16	901 008 20 2	16,21 €	0,050	100	46	70
25x3/4"	16	901 008 25 2	16,21 €	0,076	100	45	71
32x1"	16	901 008 32 2	21,39 €	0,138	50	47	81
40x1 1/4"	16	901 008 40 2	29,32 €	0,307	35	56	100
50x1 1/2"	16	901 008 50 2	35,65 €	0,290	32	68	116
63x 2"	16	901 008 63 2	45,02 €	0,480	10	68	116
75x2 1/2"	16	901 008 75 2	82,74 €	0,735	5	75	122
90x3"	16	901 008 90 2	107,29 €	1,175	4	80	142
110x4"	16	901 08 110 2	143,75 €	1,442	2	83	138

PE Dış Dişli Adaptör
PE Male Threaded Adaptor



Çap Dia	Basınç PN	Kod Code	Fiyat (Adet) Price (Pcs)	Kg /Adet Kg/Pcs	Koli/Ad. Box/Pcs	L (mm)	L1 (mm)	Z (mm)
20x1/2"	16	901 007 20 2	8,79 €	0,013	100	60	17	33
25x3/4"	16	901 007 25 2	9,25 €	0,018	100	65	18	34
32x1"	16	901 007 32 2	12,24 €	0,032	90	76	21	42
40x1 1/4"	16	901 007 40 2	16,73 €	0,055	40	82	23	43
50x1 1/2"	16	901 007 50 2	19,83 €	0,075	25	98	24	48
63x 2"	16	901 007 63 2	25,76 €	0,140		104	29	55

PE Çelik Geçiş Adaptörü Dış Dişli
PE Steel Transition Adaptor Male Threaded

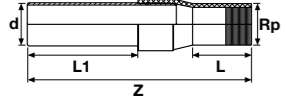

Çap Dia	Basınç PN	Kod Code	Fiyat (Adet) Price (Pcs)	Kg /Adet Kg/Pcs	Koli/Ad. Box/Pcs	L (mm)	L1 (mm)	Z (mm)
20x1/2"	16	901 100 20 2	1	0,164		45	77	182
25x3/4"	16	901 100 25 2	27,89 €	0,186		47	83	194
32x1"	16	901 100 32 2	34,27 €	0,376		50	96	229
32x3/4"	16	901 101 32 2	1	0,236		50	96	229
40x1 1/4"	16	901 100 40 2	38,01 €	0,460		54	101	233
50x1 1/2"	16	901 100 50 2	44,45 €	0,592		54	103	236
63x 2"	16	901 100 63 2	64,80 €	0,910		58	111	253
75x2 1/2"	16	901 100 75 2	104,48 €	1,400		70	135	316
90x3"	16	901 100 90 2	140,70 €	2,000		80	145	343
110x4"	16	901 10 110 2	201,37 €	2,900		85	158	360

HDPE

KONFEKSİYON EK PARÇALAR HAND-MADE FITTINGS

ÜRETİM STANDARDI

PRODUCTION STANDARD

TS EN 12201-3 +A1

ÇAP / SIZE Ø75 - Ø630



11° Dirsek (Konfeksiyon)
11° Elbow (Hand-made)

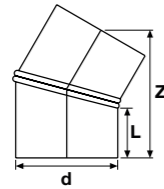

PE100 SDR11

Çap Dia	Basınç PN	Kod Code	Fiyat (Adet) Price (Pcs)	Kg /Adet Kg/Pcs	Koli/Adet Box/Pcs	L (mm)	Z (mm)
90	16	905 0 090 2	☺	0,528	24	120	129
110	16	905 0 110 2	☺	0,977	18	150	161
125	16	905 0 125 2	☺	1,273	12	150	162
140	16	905 0 140 2	☺	1,590	12	150	163
160	16	905 0 160 2	☺	2,101	9	150	165
180	16	905 0 180 2	☺	2,669	4	150	167
200	16	905 0 200 2	☺	3,318	4	150	169
225	16	905 0 225 2	☺	4,218	2	150	172
250	16	905 0 250 2	☺	6,869	2	200	224
280	16	905 0 280 2	☺	8,668	1	200	227
315	16	905 0 315 2	☺	11,008	1	200	230
355	16	905 0 355 2	☺	16,705	1	240	274
400	16	905 0 400 2	☺	21,435	1	240	279

PE100 SDR17

Çap Dia	Basınç PN	Kod Code	Fiyat (Adet) Price (Pcs)	Kg /Adet Kg/Pcs	Koli/Adet Box/Pcs	L (mm)	Z (mm)
90	10	905 0 090 1	☺	0,364	24	120	129
110	10	905 0 110 1	☺	0,675	18	150	161
125	10	905 0 125 1	☺	0,861	12	150	162
140	10	905 0 140 1	☺	1,083	12	150	163
160	10	905 0 160 1	☺	1,424	9	150	165
180	10	905 0 180 1	☺	1,810	4	150	167
200	10	905 0 200 1	☺	2,249	4	150	169
225	10	905 0 225 1	☺	2,875	2	150	172
250	10	905 0 250 1	☺	4,664	2	200	224
280	10	905 0 280 1	☺	5,850	1	200	227
315	10	905 0 315 1	☺	7,482	1	200	230
355	10	905 0 355 1	☺	11,359	1	240	274
400	10	905 0 400 1	☺	14,532	1	240	279

30° Dirsek (Konfeksiyon)
30° Elbow (Hand-made)

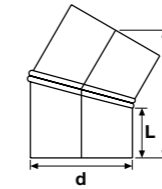

PE100 SDR11

Çap Dia	Basınç PN	Kod Code	Fiyat (Adet) Price (Pcs)	Kg /Adet Kg/Pcs	Koli/Adet Box/Pcs	L (mm)	Z (mm)
75	16	907 0 075 2	☺	0,323		100	120
90	16	907 0 090 2	☺	0,475	24	100	124
110	16	907 0 110 2	☺	1,033	18	150	179
125	16	907 0 125 2	☺	1,359	12	150	183
140	16	907 0 140 2	☺	1,717	12	150	188
160	16	907 0 160 2	☺	2,288	9	150	193
180	16	907 0 180 2	☺	2,930	4	150	198
200	16	907 0 200 2	☺	3,682	4	150	204
225	16	907 0 225 2	☺	4,716	2	150	210
250	16	907 0 250 2	☺	7,565	2	200	267
280	16	907 0 280 2	☺	9,643	1	200	275
315	16	907 0 315 2	☺	12,390	1	200	284
355	16	907 0 355 2	☺	18,688	1	240	335
400	16	907 0 400 2	☺	24,243	1	240	347

PE100 SDR17

Çap Dia	Basınç PN	Kod Code	Fiyat (Adet) Price (Pcs)	Kg /Adet Kg/Pcs	Koli/Adet Box/Pcs	L (mm)	Z (mm)
75	10	907 0 075 1	☺	0,224		100	120
90	10	907 0 090 1	☺	0,327	24	100	124
110	10	907 0 110 1	☺	0,714	18	150	179
125	10	907 0 125 1	☺	0,919	12	150	183
140	10	907 0 140 1	☺	1,169	12	150	188
160	10	907 0 160 1	☺	1,550	9	150	193
180	10	907 0 180 1	☺	1,987	4	150	198
200	10	907 0 200 1	☺	2,496	4	150	204
225	10	907 0 225 1	☺	3,215	2	150	210
250	10	907 0 250 1	☺	5,137	2	200	267
280	10	907 0 280 1	☺	6,508	1	200	275
315	10	907 0 315 1	☺	8,422	1	200	284
355	10	907 0 355 1	☺	12,708	1	240	335
400	10	907 0 400 1	☺	16,436	1	240	347

45° Dirsek (Konfeksiyon)
45° Elbow (Hand-made)



PE100 SDR11

Çap Dia	Basınç PN	Kod Code	Fiyat (Adet) Price (Pcs)	Kg /Adet Kg/Pcs	Koli/Adet Box/Pcs	L (mm)	Z (mm)
710	16	908 0 710 2	①	130,260	24	240	495
800	16	908 0 800 2	①	177,288	18	250	524
900	16	908 0 900 2	①	264,180	12	300	545

PE100 SDR17

Çap Dia	Basınç PN	Kod Code	Fiyat (Adet) Price (Pcs)	Kg /Adet Kg/Pcs	Koli/Adet Box/Pcs	L (mm)	Z (mm)
710	10	908 0 710 1	①	88,176	24	240	495
800	10	908 0 800 1	①	119,616	18	250	524
900	10	908 0 900 1	①	177,378	12	300	545
1000	10	908 1 000 1	①	227,150	12	300	642
1200	10	908 1 200 1	①	439,636	9	300	684
1400	10	908 1 400 1	①	605,820	4	400	933
1600	10	908 1 600 1	①	831,708	4	400	975

60° Dirsek (Konfeksiyon)
60° Elbow (Hand-made)

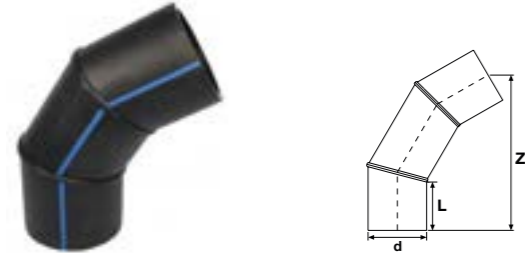

PE100 SDR11

Çap Dia	Basınç PN	Kod Code	Fiyat (Adet) Price (Pcs)	Kg /Adet Kg/Pcs	Koli/Adet Box/Pcs	L (mm)	Z (mm)
710	16	909 0 710 2	①	143,000	24	240	560
800	16	909 0 800 2	①	195,548	18	250	596
900	16	909 0 900 2	①	290,220	12	250	625

PE100 SDR17

Çap Dia	Basınç PN	Kod Code	Fiyat (Adet) Price (Pcs)	Kg /Adet Kg/Pcs	Koli/Adet Box/Pcs	L (mm)	Z (mm)
710	10	909 0 710 1	①	96,800	24	240	560
800	10	909 0 800 1	①	131,936	18	250	596
900	10	909 0 900 1	①	194,862	12	250	625
1000	10	909 0 1000 1	①	251,300	12	300	733
1200	10	909 0 1200 1	①	483,128	9	300	791
1400	10	909 0 1400 1	①	672,750	4	400	1064
1600	10	909 0 1600 1	①	932,274	4	400	1122

90° Dirsek (Konfeksiyon)
90° Elbow (Hand-made)

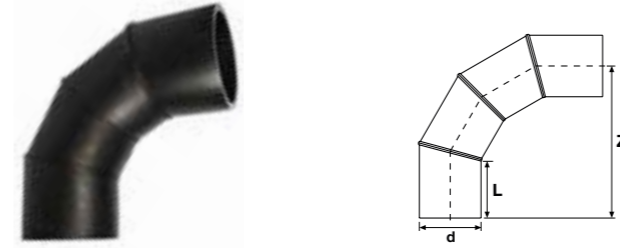

PE100 SDR11

Çap Dia	Basınç PN	Kod Code	Fiyat (Adet) Price (Pcs)	Kg /Adet Kg/Pcs	Koli/Adet Box/Pcs	L (mm)	Z (mm)
710	16	910 0 710 2	①	198,900	24	240	868
800	16	910 0 800 2	①	272,572	18	250	923
900	16	910 0 900 2	①	403,830	12	250	973

PE100 SDR17

Çap Dia	Basınç PN	Kod Code	Fiyat (Adet) Price (Pcs)	Kg /Adet Kg/Pcs	Koli/Adet Box/Pcs	L (mm)	Z (mm)
710	10	910 0 710 1	①	134,640	24	240	868
800	10	910 0 800 1	①	183,904	18	250	923
900	10	910 0 900 1	①	271,143	12	250	973
1000	10	910 0 1000 1	①	350,700	12	300	1142
1200	10	910 0 1200 1	①	672,292	9	300	1142
1400	10	910 0 1400 1	①	940,125	4	400	1142
1600	10	910 0 1600 1	①	1.307,811	4	400	1142

Eşit TE (Konfeksiyon)
Equal TEE (Hand-made)

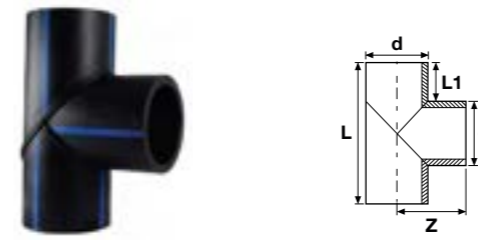

PE100 SDR11

Çap Dia	Basınç PN	Kod Code	Fiyat (Adet) Price (Pcs)	Kg /Adet Kg/Pcs	Koli/Adet Box/Pcs	L (mm)	L1 (mm)	Z (mm)
560	16	911 0 560 2	①	94,270		1060	250	530
710	16	911 0 710 2	①	166,178	24	1210	250	605
800	16	911 0 800 2	①	223,544	18	1300	250	650
900	16	911 0 900 2	①	329,923	12	1500	300	750

PE100 SDR17

Çap Dia	Basınç PN	Kod Code	Fiyat (Adet) Price (Pcs)	Kg /Adet Kg/Pcs	Koli/Adet Box/Pcs	L (mm)	L1 (mm)	Z (mm)
710	10	911 0 710 1	①	113,062	24	1210	250	605
800	10	911 0 800 1	①	151,561	18	1300	250	650
900	10	911 0 900 1	①	222,435	12	1500	300	750
1000	10	911 0 1000 1	①	315,669	12	1700	350	850
1200	10	911 0 1200 1	①	515,119	9	1900	350	950
1400	10	911 0 1400 1	①	830,564	4	2300	450	1150
1600	10	911 0 1600 1	①	1.252,127	4	2600	550	1350

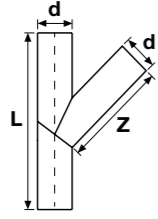
45° Çatal Te (Konfeksiyon)
 45° Elbow Tee (Hand-made)
**PE100 SDR11**

Çap Dia	Basınç PN	Kod Code	Fiyat (Adet) Price (Pcs)	Kg /Adet Kg/Pcs	Koli/Adet Box/Pcs	L (mm)	Z (mm)
90	16	912 00 90 2	Ⓛ	1,693		556	333
125	16	912 0 125 2	Ⓛ	3,272		577	351
140	16	912 0 140 2	Ⓛ	4,195		598	369
180	16	912 0 180 2	Ⓛ	7,496		655	417
200	16	912 0 200 2	Ⓛ	11,152		783	491
225	16	912 0 225 2	Ⓛ	14,572		818	522
250	16	912 0 250 2	Ⓛ	21,121		954	602
280	16	912 0 280 2	Ⓛ	27,435		996	638
315	16	912 0 315 2	Ⓛ	39,845		1145	730
355	16	912 0 355 2	Ⓛ	52,718		1202	779
400	16	912 0 400 2	Ⓛ	69,990		1266	833
450	16	912 0 450 2	Ⓛ	92,775		1336	893
500	16	912 0 500 2	Ⓛ	119,668		1407	954
560	16	912 0 560 2	Ⓛ	157,683		1492	1026
630	16	912 0 630 2	Ⓛ	210,385		1591	1110

PE100 SDR17

Çap Dia	Basınç PN	Kod Code	Fiyat (Adet) Price (Pcs)	Kg /Adet Kg/Pcs	Koli/Adet Box/Pcs	L (mm)	Z (mm)
90	16	912 00 90 1	Ⓛ	1,169		556	333
125	16	912 0 125 1	Ⓛ	2,221		577	351
140	16	912 0 140 1	Ⓛ	2,867		598	369
180	16	912 0 180 1	Ⓛ	5,103		655	417
200	16	912 0 200 1	Ⓛ	7,585		783	491
225	16	912 0 225 1	Ⓛ	9,976		818	522
250	16	912 0 250 1	Ⓛ	14,397		954	602
280	16	912 0 280 1	Ⓛ	18,577		996	638
315	16	912 0 315 1	Ⓛ	27,188		1145	730
355	16	912 0 355 1	Ⓛ	35,994		1202	779
400	16	912 0 400 1	Ⓛ	47,662		1266	833
450	16	912 0 450 1	Ⓛ	63,086		1336	893
500	16	912 0 500 1	Ⓛ	81,673		1407	954
560	16	912 0 560 1	Ⓛ	107,515		1492	1026
630	16	912 0 630 1	Ⓛ	144,020		1591	1110

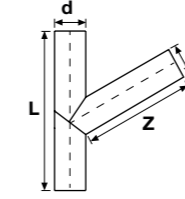
60° Çatal Te (Konfeksiyon)
 60° Elbow Tee (Hand-made)
**PE100 SDR11**

Çap Dia	Basınç PN	Kod Code	Fiyat (Adet) Price (Pcs)	Kg /Adet Kg/Pcs	Koli/Adet Box/Pcs	L (mm)	Z (mm)
90	16	914 00 90 2	Ⓛ	1,623		527	295
110	16	914 0 110 2	Ⓛ	2,364		527	295
125	16	914 0 125 2	Ⓛ	3,156		544	308
140	16	914 0 140 2	Ⓛ	4,039		562	321
160	16	914 0 160 2	Ⓛ	5,493		585	339
180	16	914 0 180 2	Ⓛ	7,165		608	356
200	16	914 0 200 2	Ⓛ	10,696		731	423
225	16	914 0 225 2	Ⓛ	13,929		760	445
250	16	914 0 250 2	Ⓛ	20,234		889	517
280	16	914 0 280 2	Ⓛ	26,190		923	543
315	16	914 0 315 2	Ⓛ	38,110		1064	623
355	16	914 0 355 2	Ⓛ	50,199		1110	658
400	16	914 0 400 2	Ⓛ	66,382		1162	697
450	16	914 0 450 2	Ⓛ	87,691		1220	740
500	16	914 0 500 2	Ⓛ	112,566		1277	783
560	16	914 0 560 2	Ⓛ	147,812		1347	835
630	16	914 0 630 2	Ⓛ	196,405		1427	896

PE100 SDR17

Çap Dia	Basınç PN	Kod Code	Fiyat (Adet) Price (Pcs)	Kg /Adet Kg/Pcs	Koli/Adet Box/Pcs	L (mm)	Z (mm)
90	10	914 00 90 1	Ⓛ	1,120		527	295
110	10	914 0 110 1	Ⓛ	1,637		527	295
125	10	914 0 125 1	Ⓛ	2,140		544	308
140	10	914 0 140 1	Ⓛ	2,758		562	321
160	10	914 0 160 1	Ⓛ	3,732		585	339
180	10	914 0 180 1	Ⓛ	4,872		608	356
200	10	914 0 200 1	Ⓛ	7,268		731	423
225	10	914 0 225 1	Ⓛ	9,524		760	445
250	10	914 0 250 1	Ⓛ	13,776		889	517
280	10	914 0 280 1	Ⓛ	17,716		923	543
315	10	914 0 315 1	Ⓛ	25,974		1064	623
355	10	914 0 355 1	Ⓛ	34,232		1110	658
400	10	914 0 400 1	Ⓛ	45,146		1162	697
450	10	914 0 450 1	Ⓛ	59,548		1220	740
500	10	914 0 500 1	Ⓛ	76,714		1277	783
560	10	914 0 560 1	Ⓛ	100,630		1347	835
630	10	914 0 630 1	Ⓛ	134,216		1427	896

İnegal TE (Konfeksiyon)
Reducer Tee (Hand-made)

PE100 SDR17

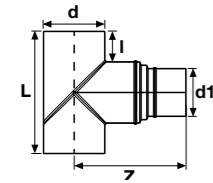
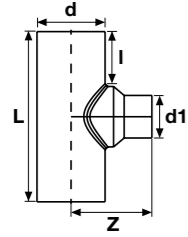

Çap Dia	Basınç PN	Kod Code	Tip Type	Fiyat (Adet) Price (Pcs)	I (mm)	Z (mm)	L (mm)
355-315	16	916 0 355315 1	B	⌚	273	660,5	901
355-280	16	916 0 355280 1	B	⌚	273	780,5	901
355-250	16	916 0 355250 1	B	⌚	273	780,5	901
355-225	16	916 0 355225 1	B	⌚	273	780,5	901
355-200	16	916 0 355200 1	B	⌚	273	900,5	901
355-180	16	916 0 355180 1	A	⌚	273	338	568
355-160	16	916 0 355160 1	A	⌚	184	331	568
355-140	16	916 0 355140 1	A	⌚	184	325	548
355-125	16	916 0 355125 1	A	⌚	184	320	528
355-110	16	916 0 355110 1	A	⌚	184	315	528
355-90	16	916 0 35590 1	A	⌚	184	312	508
400-355	16	916 0 400355 1	B	⌚	290	720	980
400-315	16	916 0 400315 1	B	⌚	290	740	980
400-280	16	916 0 400280 1	B	⌚	290	860	980
400-250	16	916 0 400250 1	B	⌚	290	860	980
400-225	16	916 0 400225 1	B	⌚	290	860	980
400-200	16	916 0 400200 1	A	⌚	199	367	623
400-180	16	916 0 400180 1	A	⌚	199	360	623
400-160	16	916 0 400160 1	A	⌚	199	353	598
400-140	16	916 0 400140 1	A	⌚	199	347	578
400-125	16	916 0 400125 1	A	⌚	199	342	578
400-110	16	916 0 400110 1	A	⌚	199	337	558
400-90	16	916 0 40090 1	A	⌚	199	334	538
400-63	16	916 0 40063 1	A	⌚	199	334	538
450-400	16	916 0 450400 1	B	⌚	305	780	1060
450-355	16	916 0 450355 1	B	⌚	305	810	1060
450-315	16	916 0 450315 1	B	⌚	305	830	1060
450-280	16	916 0 450280 1	B	⌚	305	950	1060
450-250	16	916 0 450250 1	B	⌚	305	950	1060
450-225	16	916 0 450225 1	A	⌚	205	400	680
450-200	16	916 0 450200 1	A	⌚	215	392	680
450-180	16	916 0 450180 1	A	⌚	215	385	655
450-160	16	916 0 450160 1	A	⌚	215	378	630
450-140	16	916 0 450140 1	A	⌚	215	372	630
450-125	16	916 0 450125 1	A	⌚	215	367	610
450-110	16	916 0 450110 1	A	⌚	215	362	590
450-90	16	916 0 45090 1	A	⌚	215	359	590
500-450	16	916 0 500450 1	B	⌚	330	840	1160
500-400	16	916 0 500400 1	B	⌚	330	900	1160
500-355	16	916 0 500355 1	B	⌚	330	930	1160
500-315	16	916 0 500315 1	B	⌚	330	950	1160
500-280	16	916 0 500280 1	B	⌚	330	1070	1160
500-250	16	916 0 500250 1	A	⌚	232	434	744
500-225	16	916 0 500225 1	A	⌚	232	425	744
500-200	16	916 0 500200 1	A	⌚	232	417	714
500-180	16	916 0 500180 1	A	⌚	232	410	689
500-160	16	916 0 500160 1	A	⌚	232	403	689
500-140	16	916 0 500140 1	A	⌚	232	397	664
500-125	16	916 0 500125 1	A	⌚	232	392	644
500-110	16	916 0 500110 1	A	⌚	232	387	644
500-90	16	916 0 50090 1	A	⌚	232	384	624

PP-B

KAPLIN VANALAR COMPRESSION VALVES

ÜRETİM STANDARTI
PRODUCTION STANDARD | TS ISO 17885

ÇAP / SIZE Ø20 - Ø110



PP Çift Tarafı Dişi Çıkışlı Single Vana
PP Both Sides Female Threaded Single Union Ball Valve

YENİ / NEW

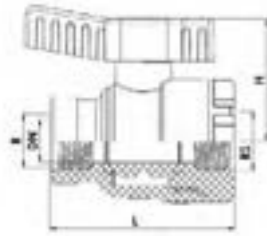

Çap Dia	Rp (Inch)	Basınç Pn	Kod Code	Fiyat (Adet) Price (Pcs)
1/2"	1/2"	16	EX234 000 20 2	Ⓣ
3/4"	3/4"	16	EX234 000 25 2	Ⓣ
3/4"	1"	16	EX234 000 25 3	Ⓣ
1"	3/4"	16	EX234 000 32 2	Ⓣ
1"	1"	16	EX234 000 32 3	Ⓣ
1"	1 1/4"	16	EX234 000 32 4	Ⓣ
1 1/4"	1"	16	EX234 000 40 2	Ⓣ
1 1/4"	1 1/4"	16	EX234 000 40 3	Ⓣ
1 1/4"	1 1/2"	16	EX234 000 40 4	Ⓣ
1 1/2"	1 1/4"	16	EX234 000 50 2	Ⓣ
1 1/2"	1 1/2"	16	EX234 000 50 3	Ⓣ
1 1/2"	2"	16	EX234 000 50 4	Ⓣ
2"	1 1/2"	16	EX234 000 63 2	Ⓣ
2"	2"	16	EX234 000 63 3	Ⓣ
2"	2 1/2"	16	EX234 000 63 4	Ⓣ
2 1/2"	2"	16	EX234 000 75 2	Ⓣ
2 1/2"	2 1/2"	16	EX234 000 75 3	Ⓣ
2 1/2"	3"	16	EX234 000 75 4	Ⓣ
3"	2 1/2"	16	EX234 000 90 2	Ⓣ
3"	3"	16	EX234 000 90 3	Ⓣ
3"	4"	16	EX234 000 90 4	Ⓣ
4"	3"	16	EX234 000 110 2	Ⓣ
4"	4"	16	EX234 000 110 3	Ⓣ

PP Tek Tarafı Erkek Tek Tarafı Dişi Çıkışlı Single Vana
PP One Side Male Threaded One Side Female Threaded Single Union Ball Valve

YENİ / NEW

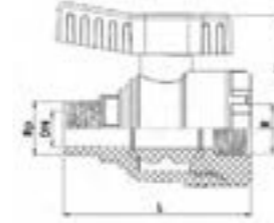

Çap Dia	Rp (Inch)	Basınç Pn	Kod Code	Fiyat (Adet) Price (Pcs)
1/2"	1/2"	16	EX234 100 20 2	Ⓣ
3/4"	3/4"	16	EX234 100 25 2	Ⓣ
3/4"	1"	16	EX234 100 25 3	Ⓣ
1"	3/4"	16	EX234 100 32 2	Ⓣ
1"	1"	16	EX234 100 32 3	Ⓣ
1"	1 1/4"	16	EX234 100 32 4	Ⓣ
1 1/4"	1"	16	EX234 100 40 2	Ⓣ
1 1/4"	1 1/4"	16	EX234 100 40 3	Ⓣ
1 1/4"	1 1/2"	16	EX234 100 40 4	Ⓣ
1 1/2"	1 1/4"	16	EX234 100 50 2	Ⓣ
1 1/2"	1 1/2"	16	EX234 100 50 3	Ⓣ
1 1/2"	2"	16	EX234 100 50 4	Ⓣ
2"	1 1/2"	16	EX234 100 63 2	Ⓣ
2"	2"	16	EX234 100 63 3	Ⓣ
2"	2 1/2"	16	EX234 100 63 4	Ⓣ
2 1/2"	2"	16	EX234 100 75 2	Ⓣ
2 1/2"	2 1/2"	16	EX234 100 75 3	Ⓣ
2 1/2"	3"	16	EX234 100 75 4	Ⓣ
3"	2 1/2"	16	EX234 100 90 2	Ⓣ
3"	3"	16	EX234 100 90 3	Ⓣ
3"	4"	16	EX234 100 90 4	Ⓣ
4"	3"	16	EX234 100 110 2	Ⓣ
4"	4"	16	EX234 100 110 3	Ⓣ

PP Tek Tarafı Dişi Tek Tarafı Kaplin Çıkışlı Single Vana
PP One Side Female Threaded One Side Compression Outlet Single Union Ball Valve

YENİ / NEW

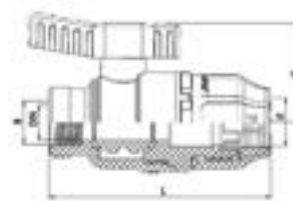

Çap Dia	Rp (Inch)	Basınç Pn	Kod Code	Fiyat (Adet) Price (Pcs)
20	1/2"	16	EX234 200 20 2	Ⓣ
25	3/4"	16	EX234 200 25 2	Ⓣ
32	1"	16	EX234 200 32 2	Ⓣ
40	1"	16	EX234 200 40 2	Ⓣ
40	1 1/4"	16	EX234 200 40 3	Ⓣ
50	1 1/4"	16	EX234 200 50 2	Ⓣ
50	1 1/2"	16	EX234 200 50 3	Ⓣ
63	2"	16	EX234 200 63 2	Ⓣ
75	2 1/2"	16	EX234 200 75 2	Ⓣ
90	3"	16	EX234 200 90 2	Ⓣ
110	4"	16	EX234 200 110 2	Ⓣ

PP Tek Tarafı Erkek Tek Tarafı Kaplin Çıkışlı Single Vana
PP One Side Male Threaded One Side Compression Outlet Single Union Ball Valve

YENİ / NEW



Çap Dia	Rp (Inch)	Basınç Pn	Kod Code	Fiyat (Adet) Price (Pcs)
20	1/2"	16	EX234 300 20 2	Ⓣ
25	3/4"	16	EX234 300 25 2	Ⓣ
32	1"	16	EX234 300 32 2	Ⓣ
40	1"	16	EX234 300 40 2	Ⓣ
40	1 1/4"	16	EX234 300 40 3	Ⓣ
50	1 1/4"	16	EX234 300 50 2	Ⓣ
50	1 1/2"	16	EX234 300 50 3	Ⓣ
63	2"	16	EX234 300 63 2	Ⓣ
75	2 1/2"	16	EX234 300 75 2	Ⓣ
90	3"	16	EX234 300 90 2	Ⓣ
110	4"	16	EX234 300 110 2	Ⓣ

PP Tek Tarafı Kaplin Tek Tarafı Dişi Çıkışlı Single Vana

PP One Side Compression Outlet One Side Female Threaded Single Union Ball Valve

YENİ / NEW

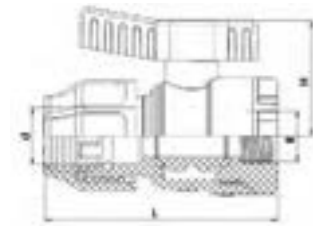

Çap Dia	Rp (Inch)	Basınç Pn	Kod Code	Fiyat (Adet) Price (Pcs)
20	1/2"	16	EX234 400 20 2	Ⓟ
25	3/4"	16	EX234 400 25 2	Ⓟ
25	1"	16	EX234 400 25 3	Ⓟ
32	3/4"	16	EX234 400 32 2	Ⓟ
32	1"	16	EX234 400 32 3	Ⓟ
32	1 1/4"	16	EX234 400 32 4	Ⓟ
40	1"	16	EX234 400 40 2	Ⓟ
40	1 1/4"	16	EX234 400 40 3	Ⓟ
40	1 1/2"	16	EX234 400 40 4	Ⓟ
50	1 1/4"	16	EX234 400 50 2	Ⓟ
50	1 1/2"	16	EX234 400 50 3	Ⓟ
50	2"	16	EX234 400 50 4	Ⓟ
63	1 1/2"	16	EX234 400 63 2	Ⓟ
63	2"	16	EX234 400 63 3	Ⓟ
63	2 1/2"	16	EX234 400 63 4	Ⓟ
75	2"	16	EX234 400 75 2	Ⓟ
75	2 1/2"	16	EX234 400 75 3	Ⓟ
75	3"	16	EX234 400 75 4	Ⓟ
90	2 1/2"	16	EX234 400 90 2	Ⓟ
90	3"	16	EX234 400 90 3	Ⓟ
90	4"	16	EX234 400 90 4	Ⓟ
110	3"	16	EX234 400 110 2	Ⓟ
110	4"	16	EX234 400 110 3	Ⓟ

PP Çift Tarafı Kaplin Çıkışlı Single Vana

PP Both Sides Compression Outlet Single Union Ball Valve

YENİ / NEW

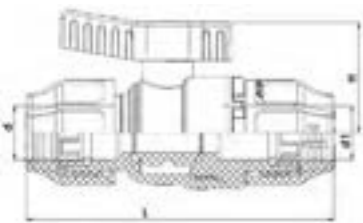

Çap Dia	Rp (Inch)	Basınç Pn	Kod Code	Fiyat (Adet) Price (Pcs)
20	20	16	EX234 500 20 2	Ⓟ
25	25	16	EX234 500 25 2	Ⓟ
32	32	16	EX234 500 32 2	Ⓟ
32	40	16	EX234 500 32 3	Ⓟ
40	40	16	EX234 500 40 2	Ⓟ
40	50	16	EX234 500 40 3	Ⓟ
50	50	16	EX234 500 50 2	Ⓟ
63	63	16	EX234 500 63 2	Ⓟ
75	75	16	EX234 500 75 2	Ⓟ
90	90	16	EX234 500 90 2	Ⓟ
110	110	16	EX234 500 110 2	Ⓟ

U-PVC Küresel Tek Taraflı Vana Çift Taraf Kaplin Çıkışlı

U-PVC Single Union Ball Valve Both Sides Compression Outlet

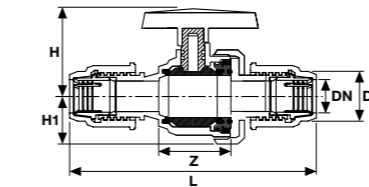

Çap Dia	Basınç Pn	Kod Code	Fiyat (Adet) Price (Pcs)	Koli Adet Box Pcs	DN (mm)	Z (mm)	L (mm)	H (mm)	H1 (mm)
20	16	EX233 300 20 2	6,19 €	90	15	52	129	47	27
25	16	EX233 300 25 2	6,55 €	60	20	58	140	51	31
32	16	EX233 300 32 2	7,74 €	45	25	61	150	63	33
40	16	EX233 300 40 2	8,33 €	30	32	73	175	67	42
50	16	EX233 300 50 2	9,76 €	15	40	82	200	86	46
63	16	EX233 300 63 2	12,85 €	12	50	95	224	101	58
75	16	EX233 300 75 2	33,32 €	6	65	118	255	110	64
90	16	EX233 300 90 2	44,03 €	2	80	139	292	137	90
110	16	EX233 30 110 2	65,45 €	2	100	165	340	150	106

U-PVC Küresel Tek Taraf İçten Dişi Tek Taraf Kaplin Çıkışlı Tek Taraflı Vana

U-PVC One Side Female Threaded One Side Compression Outlet Single Union Ball Valve

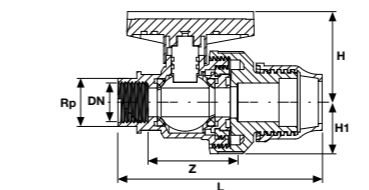

Çap Dia	Rp (Inch)	Basınç Pn	Kod Code	Fiyat (Adet) Price (Pcs)	Koli Adet Box Pcs	DN (mm)	Z (mm)	L (mm)	H (mm)	H1 (mm)
20	1/2"	16	EX233 100 20 2	7,31 €	55	15	52	104	47	27
25	3/4"	16	EX233 100 25 2	7,72 €	75	20	58	108	51	31
32	1"	16	EX233 100 32 2	9,29 €	60	25	61	120	63	33
40	1 1/4"	16	EX233 100 40 2	9,81 €	30	32	73	158	67	42
50	1 1/2"	16	EX233 100 50 2	11,27 €	24	40	82	175	86	46
63	2"	16	EX233 100 63 2	13,98 €	12	50	95	190	101	58
75	2 1/2"	16	EX233 100 75 2	33,40 €	6	65	118	225	110	64
90	3"	16	EX233 100 90 2	42,78 €	4	80	139	260	137	90
110	4"	16	EX233 10 110 2	63,65 €	2	100	165	305	150	106

U-PVC Küresel Tek Taraf Dıştan Dişi Tek Taraf Kaplin Çıkışlı Tek Taraflı Vana

U-PVC One Side Male Threaded One Side Compression Outlet Single Union Ball Valve

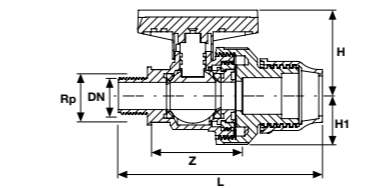

Çap Dia	Rp (Inch)	Basınç Pn	Kod Code	Fiyat (Adet) Price (Pcs)	Koli Adet Box Pcs	DN (mm)	Z (mm)	L (mm)	H (mm)	H1 (mm)
20	1/2"	16	EX233 200 20 2	6,36 €	55	15	52	116	47	27
25	3/4"	16	EX233 200 25 2	6,78 €	60	20	58	125	51	31
32	1"	16	EX233 200 32 2	8,14 €	60	25	61	135	63	33
40	1 1/4"	16	EX233 200 40 2	8,66 €	30	32	73	160	67	42
50	1 1/2"	16	EX233 200 50 2	9,92 €	24	40	82	185	86	46
63	2"	16	EX233 200 63 2	12,63 €	12	50	95	210	101	58
75	2 1/2"	16	EX233 200 75 2	31,31 €	9	65	118	230	110	64
90	3"	16	EX233 200 90 2	40,70 €	4	80	139	270	137	90
110	4"	16	EX233 20 110 2	60,52 €	2	100	165	305	150	106

U-PVC Tek Taraf Flanş Bağlantılı Tek Taraf Kaplin Çıkışlı Tek Taraflı Küresel Vana
U-PVC Solvent Cement Single Union Ball Valve One Side Flanged

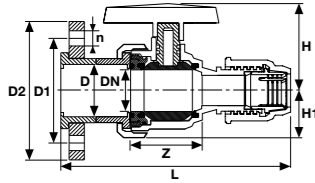

Çap Dia	Basınç Pn	Kod Code	Fiyat (Adet) Price (Pcs)	Koli Adet Box Pcs	DN (mm)	Z (mm)	L (mm)	H (mm)	H1 (mm)	D1 (mm)	D2 (mm)	n (mm)
20	16	EX233 017 020 2	7,10 €	64	15	52	133	47	27	65	96	14x4
25	16	EX233 017 025 2	7,45 €	56	20	58	150	51	31	75	105	14x4
32	16	EX233 017 032 2	8,74 €	36	25	61	169	63	33	85	115	14x4
40	16	EX233 017 040 2	9,51 €	30	32	73	195	67	42	100	140	14x4
50	16	EX233 017 050 2	10,85 €	20	40	82	228	86	46	100	150	18x4
63	16	EX233 017 063 2	13,94 €	20	50	95	251	101	58	125	165	18x4
75	16	EX233 017 075 2	33,78€	8	65	118	292	110	64	145	185	22x4
90	16	EX233 017 090 2	44,16 €	4	80	139	356	137	90	160	200	22x8
110	16	EX233 017 110 2	64,52 €	2	100	165	425	150	106	180	220	24x8

U-PVC Çift Taraf Kaplin Çıkışlı Yaylı Çekvalf
U-PVC Compression Outlet Spring Checkvalve

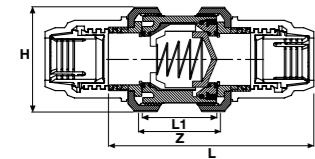

Çap Dia	Basınç Pn	Kod Code	Fiyat (Adet) Price (Pcs)	Koli Adet Box Pcs	DN (mm)	Z (mm)	L (mm)	H (mm)
20	16	EX214 01 020 2	6,03 €	60	16	52	150	54
25	16	EX214 01 025 2	6,61 €	75	20	58	165	62
32	16	EX214 01 032 2	8,22 €	60	25	61	182	66
40	16	EX214 01 040 2	9,02 €	32	32	73	205	84
50	16	EX214 01 050 2	10,17 €	20	40	82	240	92
63	16	EX214 01 063 2	13,51 €	8	50	95	275	116
75	16	EX214 01 075 2	31,62 €	9	65	118	310	146
90	16	EX214 01 090 2	35,07 €	4	80	139	360	178
110	16	EX214 01 110 2	61,52 €	2	100	165	420	210

U-PVC Tek Taraf İçten Dişli Tek Taraf Kaplin Çıkışlı Yaylı Çekvalf
U-PVC One Side Female Threaded One Side Compression Outlet Spring Checkvalve

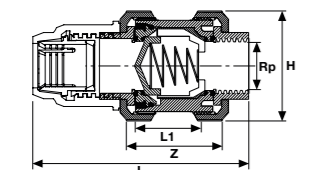

Çap Dia	Rp (Inch)	Basınç Pn	Kod Code	Fiyat (Adet) Price (Pcs)	Koli Adet Box Pcs	DN (mm)	Z (mm)	L (mm)	H (mm)
20	1/2"	16	EX215 01 020 2	6,72 €	60	16	52	104	54
25	3/4"	16	EX215 01 025 2	7,30 €	75	20	58	108	62
32	1"	16	EX215 01 032 2	9,02 €	60	25	61	120	66
40	1 1/4"	16	EX215 01 040 2	9,83 €	32	32	73	158	84
50	1 1/2"	16	EX215 01 050 2	11,21 €	20	40	82	175	92
63	2"	16	EX215 01 063 2	14,54 €	13	50	95	190	116
75	2 1/2"	16	EX215 01 075 2	33,40 €	9	65	118	225	146
90	3"	16	EX215 01 090 2	36,85 €	4	80	139	260	178
110	4"	16	EX215 01 110 2	63,25 €	2	100	165	305	210

PP-B

MAVİ SERİ
BLUE SERIES
PN 16

KAPLIN EK PARÇALAR COMPRESSION FITTINGS

ÜRETİM STANDARTI
PRODUCTION STANDARD | TS ISO 17885

ÇAP / SIZE Ø20 - Ø110



Kaplin Dişi Adaptör
Female Adaptor

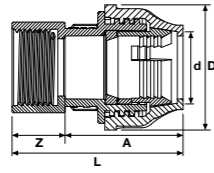

Çap Dia	Basınç Pn	Kod Code	Fiyat (Adet) Price (Pcs)	Koli Adet Box Pcs	Poşet İçi Adet Bag Pcs	D (mm)	A (mm)	Z (mm)	L (mm)
20x1/2"	16	EX70001000	0,43 €	500	50	44	48,5	14	62,5
20x3/4"	16	EX70001001	0,43 €	500	50	44	48,5	15	63,5
25x1/2"	16	EX70001002	0,57 €	350	25	50	53	14	67
25x3/4"	16	EX70001003	0,57 €	350	25	50	53	15	68
25x1"	16	EX70001004	0,57 €	350	25	50	53	17	70
32x1/2"	16	EX70001005	0,77 €	250	25	61	57	14	71
32x3/4"	16	EX70001006	0,77 €	250	25	61	57	15	72
32x1"	16	EX70001007	0,60 €	225	25	61	57	17	74
32x1 1/4"	16	EX70001008	0,77 €	200	25	61	57	20	77
40x1"	16	EX70001009	1,14 €	150	15	74,5	73,5	17	90,5
40x1 1/4"	16	EX70001010	1,16 €	135	15	74,5	73,5	20	93,5
40x1 1/2"	16	EX70001011	1,19 €	135	15	74,5	73,5	20	93,5
50x1 1/4"	16	EX70001012	1,90 €	80	10	88	84,5	20	104,5
50x1 1/2"	16	EX70001013	1,90 €	80	10	88	84,5	20	104,5
50x2"	16	EX70001014	1,90 €	80	10	88	84,5	24	108,5
63x1 1/2"	16	EX70001015	2,93 €	48	6	101	92,5	20	112,5
63x2"	16	EX70001016	2,34 €	48	6	101	92,5	24	116,5
63x2 1/2"	16	EX70001017	2,93 €	48	6	101	92,5	28	120,5
75x2"	16	EX70001018	5,14 €	30		124	127	24	151
75x2 1/2"	16	EX70001019	5,14 €	30		124	127	28	155
75x3"	16	EX70001020	5,14 €	30		124	127	30	157
90x2"	16	EX70001021	8,39 €	16		149	159	24	183
90x2 1/2"	16	EX70001022	8,43 €	16		149	159	28	187
90x3"	16	EX70001023	6,04 €	16		149	159	30	189
90x4"	16	EX70001024	8,87 €	14		149	159	36	195
110x2"	16	EX70001025	14,35 €	12		185	117	24	117
110x2 1/2"	16	EX70001026	14,35 €	12		185	117	28	117
110x3"	16	EX70001027	13,55 €	12		185	117	30	147
110x4"	16	EX70001028	13,11 €	12		185	117	36	153

Kaplin Dişi Adaptör Metal Yüzlüklü
Female Adaptor Reinforcing Ring

YENİ / NEW

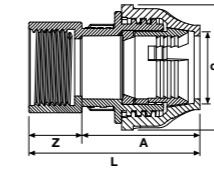

Çap Dia	Basınç Pn	Kod Code	Fiyat (Adet) Price (Pcs)	Koli Adet Box Pcs	Poşet İçi Adet Bag Pcs	D (mm)	A (mm)	Z (mm)	L (mm)
20x1/2"	16	EX70001000M	0,59 €	500	50	44	48,5	14	62,5
20x3/4"	16	EX70001001M	0,66 €	500	50	44	48,5	15	63,5
25x1/2"	16	EX70001002M	0,72 €	350	25	50	53	14	67
25x3/4"	16	EX70001003M	0,79 €	350	25	50	53	15	68
25x1"	16	EX70001004M	0,88 €	350	25	50	53	17	70
32x1/2"	16	EX70001005M	0,93 €	250	25	61	57	14	71
32x3/4"	16	EX70001006M	0,93 €	250	25	61	57	15	72
32x1"	16	EX70001007M	1,01 €	225	25	61	57	17	74
32x1 1/4"	16	EX70001008M	1,23 €	200	25	61	57	20	77
40x1"	16	EX70001009M	1,57 €	150	15	74,5	73,5	17	90,5
40x1 1/4"	16	EX70001010M	1,77 €	135	15	74,5	73,5	20	93,5
40x1 1/2"	16	EX70001011M	2,04 €	135	15	74,5	73,5	20	93,5
50x1 1/4"	16	EX70001012M	2,12 €	80	10	88	84,5	20	104,5
50x1 1/2"	16	EX70001013M	2,30 €	80	10	88	84,5	20	104,5
50x2"	16	EX70001014M	2,79 €	80	10	88	84,5	24	108,5
63x1 1/2"	16	EX70001015M	3,05 €	48	6	101	92,5	20	112,5
63x2"	16	EX70001016M	3,37 €	48	6	101	92,5	24	116,5
63x2 1/2"	16	EX70001017M	4,59 €	48	6	101	92,5	28	120,5
75x2"	16	EX70001018M	5,46 €	30		124	127	24	151
75x2 1/2"	16	EX70001019M	6,40 €	30		124	127	28	155
75x3"	16	EX70001020M	7,64 €	30		124	127	30	157
90x2"	16	EX70001021M	9,49 €	16		149	159	24	183
90x2 1/2"	16	EX70001022M	8,78 €	16		149	159	28	187
90x3"	16	EX70001023M	9,18 €	16		149	159	30	189
90x4"	16	EX70001024M	10,58 €	14		149	159	36	195
110x2"	16	EX70001025M	14,96 €	12		185	117	24	117
110x2 1/2"	16	EX70001026M	14,96 €	12		185	117	28	117
110x3"	16	EX70001027M	13,66 €	12		185	117	30	147
110x4"	16	EX70001028M	13,66 €	12		185	117	36	153

Kaplin Manşon
Coupling

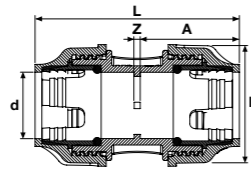

Çap Dia	Basınç Pn	Kod Code	Fiyat (Adet) Price (Pcs)	Koli Adet Box Pcs	Poşet İçi Adet Bag Pcs	D (mm)	A (mm)	Z (mm)	L (mm)
20x20	16	EX70001200	0,54 €	300	25	44	48,5	3	100
25x25	16	EX70001201	0,76 €	200	25	50	53	3	109
32x32	16	EX70001202	0,94 €	130	10	61	57	3	117
40x40	16	EX70001203	1,93 €	70	10	74,5	73,5	3	150
50x50	16	EX70001204	2,57 €	42	6	88	84,5	3	172
63x63	16	EX70001205	3,73 €	30	5	101	92,5	3	152
75x75	16	EX70001206	6,62 €	20		124	127	4	258
90x90	16	EX70001207	9,90 €	9		149	159	5	323
110x110	16	EX70001208	14,54 €	6		185	185	6	376

Kaplin Redüsiyon Manşon
Reducing Coupling

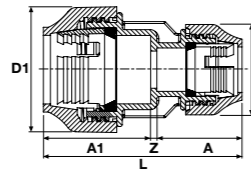

Çap Dia	Basınç Pn	Kod Code	Fiyat (Adet) Price (Pcs)	Koli Adet Box Pcs	Poşet İçi Adet Bag Pcs	D (mm)	A1 (mm)	Z (mm)	L (mm)	D1 (mm)	A (mm)
25x20	16	EX70001600	1,06 €	250	25	50	53	3	104,5	44	48,5
32x20	16	EX70001601	1,39 €	180	10	61	57	3	108,5	44	48,5
32x25	16	EX70001602	1,39 €	170	10	61	57	3	113	50	53
40x20	16	EX70001603	1,93 €	120	10	74,5	73,5	3	125	44	48,5
40x25	16	EX70001604	1,93 €	110	10	74,5	73,5	3	129,5	50	53
40x32	16	EX70001605	1,93 €	100	10	74,5	73,5	3	133,5	61	57
50x25	16	EX70001606	2,86 €	66	6	88	84,5	3	140,5	50	53
50x32	16	EX70001607	3,10 €	60	6	88	84,5	3	144,5	61	57
50x40	16	EX70001608	3,24 €	54	6	88	84,5	3	161	74,5	73,5
63x25	16	EX70001609	3,56 €	42	6	101	92,5	6	151,5	50	53
63x32	16	EX70001610	4,03 €	42	6	101	92,5	6	155,5	61	57
63x40	16	EX70001611	4,38 €	36	6	101	92,5	6	172	74,5	73,5
63x50	16	EX70001612	4,38 €	36	6	101	92,5	6	183	88	84,5
75x40	16	EX70001621	7,53 €	28		124	127	6	206,5	74,5	73,5
75x50	16	EX70001613	7,54 €	24		124	127	6	217,5	88	84,5
75x63	16	EX70001614	8,18 €	22		124	127	6	225,5	101	92,5
90x50	16	EX70001620	10,83 €	10		149	159	7	250,5	88	84,5
90x63	16	EX70001615	10,83 €	12		149	159	7	258,5	101	92,5
90x75	16	EX70001616	12,86 €	10		149	159	7	293	124	127
110x63	16	EX70001617	15,97 €	7		185	185	8	285,5	101	92,5
110x75	16	EX70001618	16,76 €	7		185	185	8	320	124	127
110x90	16	EX70001619	16,76 €	7		185	185	8	342	149	149

Kaplin Erkek Adaptör
Male Adaptor

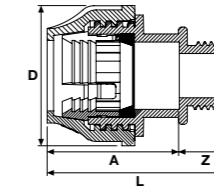

Çap Dia	Basınç Pn	Kod Code	Fiyat (Adet) Price (Pcs)	Koli Adet Box Pcs	Poşet İçi Adet Bag Pcs	D (mm)	A (mm)	Z (mm)	L (mm)
20x1/2"	16	EX70001100	0,43 €	600	50	44	48,5	14	62,5
20x3/4"	16	EX70001101	0,43 €	600	50	44	48,5	15	63,5
25x1/2"	16	EX70001102	0,57 €	425	25	50	53	14	67
25x3/4"	16	EX70001103	0,57 €	400	25	50	53	15	68
25x1"	16	EX70001104	0,57 €	400	25	50	53	17	70
32x1/2"	16	EX70001105	0,77 €	275	25	61	57	14	71
32x3/4"	16	EX70001106	0,77 €	275	25	61	57	15	72
32x1"	16	EX70001107	0,60 €	250	25	61	57	17	74
32x1 1/4"	16	EX70001108	0,77 €	250	25	61	57	20	77
40x1"	16	EX70001109	1,14 €	150	15	74,5	73,5	17	90,5
40x1 1/4"	16	EX70001110	1,16 €	135	15	74,5	73,5	20	93,5
40x1 1/2"	16	EX70001111	1,19 €	150	15	74,5	73,5	20	93,5
50x1 1/4"	16	EX70001112	1,90 €	80	10	88	84,5	20	104,5
50x1 1/2"	16	EX70001113	1,90 €	80	10	88	84,5	20	104,5
50x2"	16	EX70001114	1,90 €	80	10	88	84,5	24	108,5
63x1 1/2"	16	EX70001115	2,93 €	66	6	101	92,5	20	112,5
63x2"	16	EX70001116	2,34 €	55	6	101	92,5	24	116,5
63x2 1/2"	16	EX70001117	2,93 €	60	6	101	92,5	28	120,5
75x2"	16	EX70001118	5,14 €	32		124	127	24	151
75x2 1/2"	16	EX70001119	5,14 €	30		124	127	28	155
75x3"	16	EX70001120	5,14 €	28		124	127	30	157
90x2"	16	EX70001121	8,39 €	16		149	159	24	183
90x2 1/2"	16	EX70001122	8,43 €	16		149	159	28	187
90x3"	16	EX70001123	6,04 €	16		149	159	30	189
90x4"	16	EX70001124	8,87 €	16		149	159	36	195
110x2"	16	EX70001125	14,35 €	12		185	117	24	141
110x2 1/2"	16	EX70001126	14,35 €	12		185	117	28	145
110x3"	16	EX70001127	13,55 €	12		185	117	30	147
110x4"	16	EX70001128	13,11 €	12		185	117	36	153

Kaplin Kör Tapa
End Cap

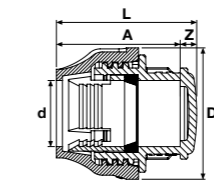

Çap Dia	Basınç Pn	Kod Code	Fiyat (Adet) Price (Pcs)	Koli Adet Box Pcs	Poşet İçi Adet Bag Pcs	D (mm)	A (mm)	Z (mm)	L (mm)
20	16	EX70001500	0,47 €	700	50	44	48,5	5,5	54
25	16	EX70001501	0,58 €	400	25	50	53	6,9	59,9
32	16	EX70001502	0,78 €	250	25	61	57	8,4	65,4
40	16	EX70001503	1,17 €	150	15	74,5	73,5	10	83,5
50	16	EX70001504	1,90 €	84	12	88	84,5	11,7	96,2
63	16	EX70001505	2,93 €	55	6	101	92,5	16	108,5
75	16	EX70001506	5,63 €	32		124	127	18	145
90	16	EX70001507	7,49 €	18		149	159	20	179
110	16	EX70001508	13,03 €	10		185	185	24	209

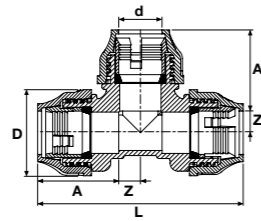
Kaplin Te
 Tee

Çap Dia	Basınç Pn	Kod Code	Fiyat (Adet) Price (Pcs)	Koli Adet Box Pcs	Poşet İçi Adet Bag Pcs	D (mm)	A (mm)	Z (mm)	L (mm)
20	16	EX70001300	1,27 €	180	15	43,7	48,5	11	119
25	16	EX70001301	1,56 €	120	10	49,8	53	13,5	133
32	16	EX70001302	2,15 €	70	5	60,8	57	17	148
40	16	EX70001303	3,43 €	45	5	74,5	73,5	21	189
50	16	EX70001304	5,22 €	24	4	88	84,5	26	221
63	16	EX70001305	6,37 €	15	3	101	92,5	32,5	250
75	16	EX70001306	14,05 €	8		124	127	38,5	331
90	16	EX70001307	20,55 €	6		149	159	46	410
110	16	EX70001308	34,24 €	4		185	185	56	482

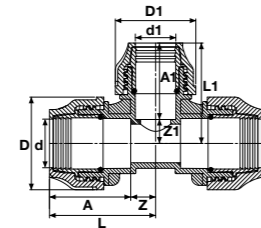
Kaplin Redüksiyon Te
 Reducing Tee

Çap Dia	Basınç Pn	Kod Code	Fiyat (Adet) Price (Pcs)	Koli Adet Box Pcs	Poşet İçi Adet Bag Pcs	D (mm)	A (mm)	Z (mm)	L (mm)	D1 (mm)	A1 (mm)	Z1 (mm)	L1 (mm)
25x20x25	16	EX70001700	1,60 €	140	10	50	53	13,5	133	44	48,5	11	119
32x20x32	16	EX70001701	2,22 €	85	5	61	57	17	148	44	48,5	11,0	119
32x25x32	16	EX70001702	2,22 €	80	5	61	57	17	148	50	53	13,5	133
40x25x40	16	EX70001703	3,43 €	50	5	74,5	73,5	21	189	50	53	13,5	133
40x32x40	16	EX70001704	3,47 €	50	5	74,5	73,5	21	189	61	57	17	148
50x25x50	16	EX70001705	4,56 €	32	4	88	84,5	26	221	50	53	13,5	133
50x32x50	16	EX70001706	4,90 €	40	4	88	84,5	26	221	61	57	17	148
50x40x50	16	EX70001707	5,22 €	28	4	88	84,5	26	221	74,5	73,5	21	189
63x25x63	16	EX70001708	6,35 €	21	3	101	92,5	32,5	250	50	53	13,5	133
63x32x63	16	EX70001709	6,64 €	24	3	101	92,5	32,5	250	61	57	17	148
63x40x63	16	EX70001710	7,25 €	18	3	101	92,5	32,5	250	74,5	73,5	21	189
63x50x63	16	EX70001711	7,58 €	18	3	101	92,5	32,5	250	88	84,5	26	221
75x50x75	16	EX70001712	12,36 €	12		124	127	38,5	331	88	84,5	26	221
75x63x75	16	EX70001713	13,29 €	12		124	127	38,5	331	101	92,5	32,5	250
90x63x90	16	EX70001714	18,55 €	7		149	159	46	410	101	92,5	32,5	250
90x75x90	16	EX70001715	20,70 €	6		149	159	46	410	124	127	38,5	331
110x63x110	16	EX70001716	28,57 €	4		185	185	56	482	101	92,5	32,5	250
110x75x110	16	EX70001717	26,95 €	4		185	185	56	482	124	127	38,5	331
110x90x110	16	EX70001718	31,60 €	4		185	185	56	482	149	159	46	410

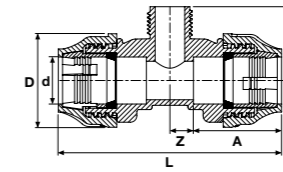
Kaplin Erkek Te
 Male Tee

Çap Dia	Basınç Pn	Kod Code	Fiyat (Adet) Price (Pcs)	Koli Adet Box Pcs	Poşet İçi Adet Bag Pcs	D (mm)	A (mm)	Z (mm)	L (mm)	H (mm)
20x1/2"x20	16	EX70001900	1,04 €	300	15	44	48,5	11	119	34,5
20x3/4"x20	16	EX70001901	1,04 €	300	15	44	48,5	11	119	35,5
20x1"x20	16	EX70001929	1,41 €	225	15	44	48,5	11	119	39,5
25x1/2"x25	16	EX70001902	1,41 €	160	10	50	53	13,5	133	37,8
25x3/4"x25	16	EX70001903	1,38 €	180	10	50	53	13,5	133	38,8
25x1"x25	16	EX70001904	1,41 €	170	10	50	53	13,5	133	42,8
25x1 1/4"x25	16	EX70001905	1,41 €	170	10	50	53	13,5	133	44,8
32x1/2"x32	16	EX70001906	1,93 €	100	10	61	57	17	148	42,5
32x3/4"x32	16	EX70001907	1,93 €	100	10	61	57	17	148	43,5
32x1"x32	16	EX70001908	1,93 €	100	10	61	57	17	148	47,5
32x1 1/4"x32	16	EX70001909	2,19 €	100	10	61	57	17	148	49,5
40x1"x40	16	EX70001910	2,82 €	70	5	74,5	73,5	21	189	53,9
40x1 1/4"x40	16	EX70001911	2,82 €	70	5	74,5	73,5	21	189	55,9
40x1 1/2"x40	16	EX70001912	2,82 €	70	5	74,5	73,5	21	189	55,9
50x1"x50	16	EX70001913	4,22 €	44	4	88	84,5	26	221	59,9
50x1 1/4"x50	16	EX70001914	4,36 €	44	4	88	84,5	26	221	61,9
50x1 1/2"x50	16	EX70001915	4,47 €	40	4	88	84,5	26	221	61,9
50x2"x50	16	EX70001916	4,47 €	40	4	88	84,5	26	221	63,9
63x1 1/4"x63	16	EX70001917	6,09 €	24	3	101	92,5	32,5	250	69,3
63x1 1/2"x63	16	EX70001918	6,24 €	24	3	101	92,5	32,5	250	69,3
63x2"x63	16	EX70001919	6,25 €	21	3	101	92,5	32,5	250	71,3
63x2 1/2"x63	16	EX70001920	6,83 €	21	3	101	92,5	32,5	250	75,3
75x2"x75	16	EX70001921	10,90 €	18		124	127	38,5	331	82,5
75x2 1/2"x75	16	EX70001922	11,22 €	12		124	127	38,5	331	86,5
75x3"x75	16	EX70001923	11,72 €	18		124	127	38,5	331	88,5
90x2 1/2"x90	16	EX70001924	16,25 €	7		149	159	46	410	86,5
90x3"x90	16	EX70001925	16,83 €	7		149	159	46	410	88,5
90x4"x90	16	EX70001926	17,31 €	7		149	159	46	410	106,3
110x3"x110	16	EX70001927	27,25 €	4		185	185	56	430	100,3
110x4"x110	16	EX70001928	25,84 €	4		185	185	56	430	106,3

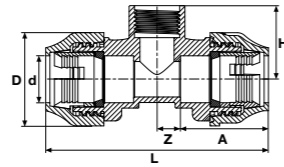
Kaplin Dişi Te
 Female Tee

Çap Dia	Basınç Pn	Kod Code	Fiyat (Adet) Price (Pcs)	Koli Adet Box Pcs	Poşet İçi Adet Bag Pcs	D (mm)	A (mm)	Z (mm)	L (mm)	H (mm)
20x1/2"x20	16	EX70002300	1,04 €	315	15	44	48,5	11	119	34,5
20x3/4"x20	16	EX70002301	1,04 €	300	15	44	48,5	11	119	35,5
25x1/2"x25	16	EX70002302	1,41 €	170	10	50	53	13,5	133	37,8
25x3/4"x25	16	EX70002303	1,38 €	160	10	50	53	13,5	133	38,8
25x1"x25	16	EX70002304	1,41 €	160	10	50	53	13,5	133	42,8
32x1/2"x32	16	EX70002305	1,93 €	100	10	61	57	17	148	42,5
32x3/4"x32	16	EX70002306	1,93 €	120	10	61	57	17	148	43,5
32 x 1" x 32	16	EX70002307	1,93 €	90	10	61	57	17	148	47,5
40x3/4"x40	16	EX70002308	2,82 €	65	5	74,5	73,5	21	189	49,9
40x1"x40	16	EX70002309	2,82 €	65	5	74,5	73,5	21	189	53,9
40x1 1/4"x40	16	EX70002310	2,82 €	65	5	74,5	73,5	21	189	55,9
50x1"x50	16	EX70002311	4,22 €	40	4	88	84,5	26	221	59,9
50x1 1/4"x50	16	EX70002312	4,36 €	40	4	88	84,5	26	221	61,9
50x1 1/2"x50	16	EX70002313	4,47 €	40	4	88	84,5	26	221	61,9
63x1 1/4"x63	16	EX70002314	6,09 €	24	3	101	92,5	32,5	250	69,3
63x1 1/2"x63	16	EX70002315	6,24 €	21	3	101	92,5	32,5	250	69,3
63x2"x63	16	EX70002316	6,25 €	20	3	101	92,5	32,5	250	71,3
75x2"x75	16	EX70002317	10,90 €	12		124	127	38,5	331	82,5
75x2 1/2"x75	16	EX70002318	11,22 €	12		124	127	38,5	331	86,5
90x2 1/2"x90	16	EX70002319	16,25 €	8		149	159	46	410	98,3
90x3"x90	16	EX70002320	16,83 €	8		149	159	46	410	100,3
110x3"x110	16	EX70002321	27,25 €	4		185	185	56	482	112,5
110x4"x110	16	EX70002322	25,84 €	4		185	185	56	482	118,5

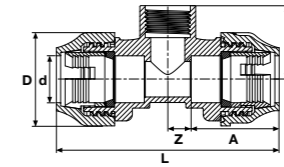
Kaplin Dişi Te Metal Yüzlüklü
 Female Tee Reinforcing Ring

Çap Dia	Basınç Pn	Kod Code	Fiyat (Adet) Price (Pcs)	Koli Adet Box Pcs	Poşet İçi Adet Bag Pcs	D (mm)	A (mm)	Z (mm)	L (mm)	H (mm)
20x1/2"x20	16	EX70002300M	1,15 €	315	15	44	48,5	11	119	34,5
20x3/4"x20	16	EX70002301M	1,40 €	300	15	44	48,5	11	119	35,5
25x1/2"x25	16	EX70002302M	1,56 €	170	10	50	53	13,5	133	37,8
25x3/4"x25	16	EX70002303M	1,56 €	160	10	50	53	13,5	133	38,8
25x1"x25	16	EX70002304M	1,82 €	160	10	50	53	13,5	133	42,8
32x1/2"x32	16	EX70002305M	2,11 €	100	10	61	57	17	148	42,5
32x3/4"x32	16	EX70002306M	2,11 €	120	10	61	57	17	148	43,5
32 x 1" x 32	16	EX70002307M	2,09 €	90	10	61	57	17	148	47,5
40x3/4"x40	16	EX70002308M	3,10 €	65	5	74,5	73,5	21	189	49,9
40x1"x40	16	EX70002309M	3,10 €	65	5	74,5	73,5	21	189	53,9
40x1 1/4"x40	16	EX70002310M	3,39 €	65	5	74,5	73,5	21	189	55,9
50x1"x50	16	EX70002311M	4,64 €	40	4	88	84,5	26	221	59,9
50x1 1/4"x50	16	EX70002312M	4,80 €	40	4	88	84,5	26	221	61,9
50x1 1/2"x50	16	EX70002313M	4,89 €	40	4	88	84,5	26	221	61,9
63x1 1/4"x63	16	EX70002314M	6,67 €	24	3	101	92,5	32,5	250	69,3
63x1 1/2"x63	16	EX70002315M	6,82 €	21	3	101	92,5	32,5	250	69,3
63x2"x63	16	EX70002316M	6,82 €	20	3	101	92,5	32,5	250	71,3
75x2"x75	16	EX70002317M	12,29 €	12		124	127	38,5	331	82,5
75x2 1/2"x75	16	EX70002318M	12,68 €	12		124	127	38,5	331	86,5
90x2 1/2"x90	16	EX70002319M	18,11 €	8		149	159	46	410	98,3
90x3"x90	16	EX70002320M	18,80 €	8		149	159	46	410	100,3
110x3"x110	16	EX70002321M	27,94 €	4		185	185	56	482	112,5
110x4"x110	16	EX70002322M	28,92 €	4		185	185	56	482	118,5

YENİ / NEW

Kaplin Dirsek
Elbow

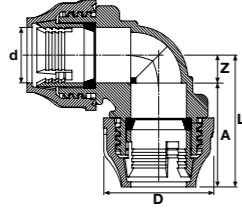

Çap Dia	Basınç Pn	Kod Code	Fiyat (Adet) Price (Pcs)	Koli Adet Box Pcs	Poşet İçi Adet Bag Pcs	D (mm)	A (mm)	Z (mm)	L (mm)
20x20	16	EX70001400	0,84 €	300	25	44	48,5	11	59,5
25x25	16	EX70001401	1,09 €	195	15	50	53	13,5	66,5
32x32	16	EX70001402	1,14 €	120	10	61	57	17	74
40x40	16	EX70001403	2,50 €	60	5	74,5	73,5	21	94,5
50x50	16	EX70001404	3,92 €	40	4	88	84,5	26	110,5
63x63	16	EX70001405	4,27 €	25	4	101	92,5	32,5	125
75x75	16	EX70001406	10,53 €	12		124	127	38,5	165,5
90x90	16	EX70001407	11,98 €	8		149	159	46	205
110x110	16	EX70001408	24,56 €	6		185	185	56	241

Kaplin Redüksiyon Dirsek
Reducing Elbow

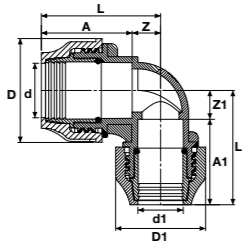

Çap Dia	Basınç Pn	Kod Code	Fiyat (Adet) Price (Pcs)	Koli Adet Box Pcs	Poşet İçi Adet Bag Pcs	D (mm)	A (mm)	Z (mm)	L (mm)	D1 (mm)	A1 (mm)	Z1 (mm)	L1 (mm)
25x20	16	EX70001800	1,10 €	210	15	50	53	13,5	66,5	44	48,5	11	59,5
32x25	16	EX70001801	1,54 €	150	10	61	57	17	74	50	53	13,5	66,5
40x32	16	EX70001802	2,46 €	85	5	74,5	73,5	21	94,5	61	57	17	74
50x40	16	EX70001803	3,71 €	52	4	88	84,5	26	110,5	74,5	73,5	21	94,5
63x50	16	EX70001804	5,38 €	32	4	101	92,5	32,5	125	88	84,5	26	110,5
75x63	16	EX70001805	9,47 €	18		124	127	38,5	165,5	101	92,5	32,5	125
90x75	16	EX70001806	14,28 €	8		149	159	46	205	124	127	38,5	165,5
110x90	16	EX70001808	21,92 €	5		185	185	56	241	149	159	46	205

Kaplin Erkek Dirsek
Male Elbow

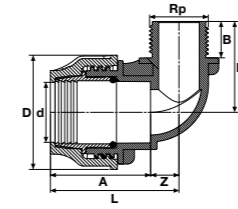

Çap Dia	Basınç Pn	Kod Code	Fiyat (Adet) Price (Pcs)	Koli Adet Box Pcs	Poşet İçi Adet Bag Pcs	D (mm)	A (mm)	Z (mm)	L (mm)	B (mm)	L1 (mm)
20x1/2"	16	EX70002000	0,38 €	475	25	44	42,5	11	53,5	14	25
20x3/4"	16	EX70002001	0,51 €	475	25	44	42,5	11	53,5	15	26
20x1"	16	EX70002025	0,51 €	400	25	44	42,5	11	53,5	17	28
25x1/2"	16	EX70002002	0,80 €	345	15	50	47,5	13,5	61	14	27,5
25x3/4"	16	EX70002003	0,78 €	330	15	50	47,5	13,5	61	15	28,5
25x1"	16	EX70002004	0,86 €	315	15	50	47,5	13,5	61	17	30,5
32x3/4"	16	EX70002005	1,19 €	210	10	61	50,5	17	67,5	15	32
32x1"	16	EX70002006	1,17 €	200	10	61	50,5	17	67,5	17	34
32x1 1/4"	16	EX70002007	1,33 €	200	10	61	50,5	17	67,5	20	37
40x1"	16	EX70002008	1,95 €	110	5	74,5	63	21	84	17	38
40x1 1/4"	16	EX70002009	1,91 €	110	5	74,5	63	21	84	20	41
40x1 1/2"	16	EX70002010	2,04 €	135	5	74,5	63	21	84	20	41
50x1 1/4"	16	EX70002011	2,83 €	68	4	88	70,5	26	96,5	20	46
50x1 1/2"	16	EX70002012	2,75 €	60	4	88	70,5	26	96,5	20	46
50x2"	16	EX70002013	2,97 €	64	4	88	70,5	26	96,5	24	50
63x1 1/2"	16	EX70002014	4,14 €	40	4	101	80,5	32,5	113	20	52,5
63x2"	16	EX70002015	3,93 €	40	4	101	80,5	32,5	113	24	56,5
63x2 1/2"	16	EX70002016	4,24 €	36	4	101	80,5	32,5	144,5	28	60,5
75x2"	16	EX70002017	7,86 €	24		124	112	38,5	150,5	24	62,5
75x2 1/2"	16	EX70002018	7,32 €	24		124	112	38,5	150,5	28	66,5
75x3"	16	EX70002019	7,72 €	22		124	112	38,5	180,5	30	68,5
90x2 1/2"	16	EX70002020	10,86 €	14		149	142	46	188	28	74
90x3"	16	EX70002021	10,50 €	14		149	142	46	188	30	76
90x4"	16	EX70002022	10,82 €	10		149	142	46	219	36	82
110x2 1/2"	16	EX70002026	17,59 €	9		185	173	56	229	28	84
110x3"	16	EX70002023	17,59 €	8		185	173	56	229	30	86
110x4"	16	EX70002024	16,15 €	8		185	173	56	229	36	92

Kaplin Dişi Dirsek
Female Elbow

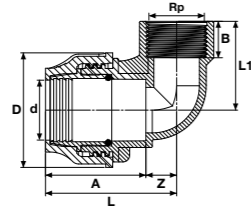

Çap Dia	Basınç Pn	Kod Code	Fiyat (Adet) Price (Pcs)	Koli Adet Box Pcs	Poşet İçi Adet Bag Pcs	D (mm)	A (mm)	Z (mm)	L (mm)	B (mm)	L1 (mm)
20x1/2"	16	EX70002400	0,38 €	450	25	44	48,5	11	59,5	14	25
20x3/4"	16	EX70002401	0,51 €	450	25	44	48,5	11	59,5	15	26
25x1/2"	16	EX70002402	0,80 €	330	15	50	53	13,5	66,5	14	27,5
25x3/4"	16	EX70002403	0,78 €	300	15	50	53	13,5	66,5	15	28,5
25x1"	16	EX70002404	0,80 €	270	15	50	53	13,5	66,5	17	30,5
32x3/4"	16	EX70002405	1,19 €	130	10	61	57	17	74	15	32
32x1"	16	EX70002406	1,17 €	120	10	61	57	17	74	17	34
32x1 1/4"	16	EX70002407	1,33 €	120	10	61	57	17	74	20	37
40x1"	16	EX70002408	1,95 €	110	5	74,5	73,5	21	94,5	17	38
40x1 1/4"	16	EX70002409	1,91 €	100	5	74,5	73,5	21	94,5	20	41
40x1 1/2"	16	EX70002410	2,04 €	95	5	74,5	73,5	21	94,5	20	41
50x1 1/4"	16	EX70002411	2,83 €	60	4	88	84,5	26	110,5	20	46
50x1 1/2"	16	EX70002412	2,75 €	60	4	88	84,5	26	110,5	20	46
63x1 1/2"	16	EX70002413	4,14 €	40	4	101	92,5	32,5	125	20	52,5
63x2"	16	EX70002414	3,93 €	36	4	101	92,5	32,5	125	24	56,5
75x2"	16	EX70002415	7,86 €	22		124	127	38,5	165,5	24	62,5
75x2 1/2"	16	EX70002416	7,32 €	22		124	127	38,5	165,5	28	66,5
90x2 1/2"	16	EX70002417	10,86 €	14		149	159	46	205	28	74
90x3"	16	EX70002418	10,50 €	12		149	159	46	205	30	76
110x3"	16	EX70002419	17,59 €	8		185	185	56	241	30	86
110x4"	16	EX70002420	16,15 €	8		185	185	56	241	36	92

Kaplin Dişi Dirsek Metal Yüzüklü
Female Elbow Reinforcing Ring

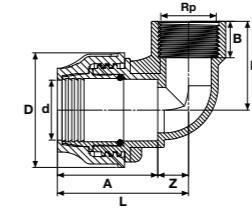

Çap Dia	Basınç Pn	Kod Code	Fiyat (Adet) Price (Pcs)	Koli Adet Box Pcs	Poşet İçi Adet Bag Pcs	D (mm)	A (mm)	Z (mm)	L (mm)	B (mm)	L1 (mm)
20x1/2"	16	EX70002400M	0,69 €	450	25	44	48,5	11	59,5	14	25
20x3/4"	16	EX70002401M	0,94 €	450	25	44	48,5	11	59,5	15	26
25x1/2"	16	EX70002402M	0,98 €	330	15	50	53	13,5	66,5	14	27,5
25x3/4"	16	EX70002403M	0,98 €	300	15	50	53	13,5	66,5	15	28,5
25x1"	16	EX70002404M	1,13 €	270	15	50	53	13,5	66,5	17	30,5
32x3/4"	16	EX70002405M	1,33 €	130	10	61	57	17	74	15	32
32x1"	16	EX70002406M	1,39 €	120	10	61	57	17	74	17	34
32x1 1/4"	16	EX70002407M	1,71 €	120	10	61	57	17	74	20	37
40x1"	16	EX70002408M	2,12 €	110	5	74,5	73,5	21	94,5	17	38
40x1 1/4"	16	EX70002409M	2,30 €	100	5	74,5	73,5	21	94,5	20	41
40x1 1/2"	16	EX70002410M	2,51 €	95	5	74,5	73,5	21	94,5	20	41
50x1 1/4"	16	EX70002411M	3,02 €	60	4	88	84,5	26	110,5	20	46
50x1 1/2"	16	EX70002412M	3,25 €	60	4	88	84,5	26	110,5	20	46
63x1 1/2"	16	EX70002413M	4,33 €	40	4	101	92,5	32,5	125	20	52,5
63x2"	16	EX70002414M	4,73 €	36	4	101	92,5	32,5	125	24	56,5
75x2"	16	EX70002415M	8,29 €	22		124	127	38,5	165,5	24	62,5
75x2 1/2"	16	EX70002416M	8,35 €	22		124	127	38,5	165,5	28	66,5
90x2 1/2"	16	EX70002417M	11,44 €	14		149	159	46	205	28	74
90x3"	16	EX70002418M	12,10 €	12		149	159	46	205	30	76
110x3"	16	EX70002419M	17,69 €	8		185	185	56	241	30	86
110x4"	16	EX70002420M	18,43 €	8		185	185	56	241	36	92

YENİ / NEW

Adaptör Sıkma Anahtarı
Adapter Key

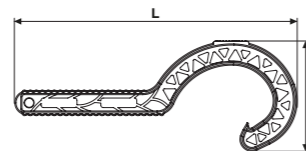

Çap Dia	Kod Code	Fiyat (Adet) Price (Pcs)	Çuval Adet Sack Pcs	Poşet İçi Adet Bag Pcs	L (mm)	h (mm)
20x25x32	EX70003000	2,78 €	700		236	92
40x50x63x75	EX70003001	7,80 €	230		338	112,5
90x110	EX70003002	9,88 €	50		456	151,5

Plastik Dişli Redüksiyon
Plastic Threaded Reducer



Çap Dia	Basınç Pn	Kod Code	Fiyat (Adet) Price (Pcs)	Çuval Adet Sack Pcs	Poşet İçi Adet Bag Pcs
3/4"x1/2"	16	EX70005000	0,86 €	3000	
1"x 3/4"	16	EX70005001	1,16 €	1800	
1 1/4"x1"	16	EX70005002	2,10 €	1000	
1 1/2"x1 1/4"	16	EX70005003	2,70 €	700	
2"x1 1/2"	16	EX70005004	2,84 €	400	

Kaplin Flanşlı Adaptör
Flanged Coupling Adaptor

YENİ / NEW

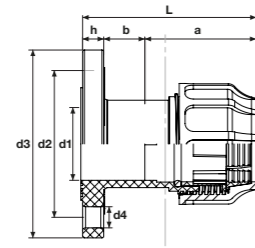

TİP-A / TYPE A

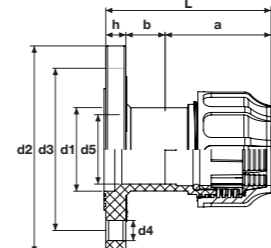

TİP-B / TYPE B

TİP-A / TYPE A

Çap Dia	Basınç Pn	Kod Code	Fiyat (Adet) Price (Pcs)	Koli Adet Box Pcs	Poşet İçi Adet Bag Pcs	DN (mm)	DN (Inch)	d1 (mm)	L (mm)	B (mm)	A (mm)	d2 (mm)	d3 (mm)	h (mm)	d4 (mm)
63	16	EX70002503	5,96 €			50	2"	62	127,7	35	74,7	160	125	18	18
75	16	EX70002504	10,32 €			65	2 1/2"	74,7	156	41	95	185	145	20	18
90	16	EX70002505	14,69 €			80	3"	90,7	190	44	124	200	160	22	18

TİP-B / TYPE B

Çap Dia	Basınç Pn	Kod Code	Fiyat (Adet) Price (Pcs)	Koli Adet Box Pcs	Poşet İçi Adet Bag Pcs	DN (mm)	DN (Inch)	d1 (mm)	d5 (mm)	L (mm)	B (mm)	A (mm)	d2 (mm)	d3 (mm)	h (mm)	d4 (mm)
63	16	EX70002603	5,96 €			65	2 1/2"	62	74,7	127,7	35	74,7	185	145	18	18
75	16	EX70002604	10,32 €			80	3"	74,7	90,7	156	41	95	200	160	20	18
90	16	EX70002605	14,69 €			100	4"	90,7	116,1	190	44	124	220	181	22	18
110	16	EX70002606	23,28 €			100	4"	110	116,1	227,5	53	150,5	220	181	24	18

PP-B

KAPLIN EK PARÇALAR COMPRESSION FITTINGS

ÜRETİM STANDARDI

PRODUCTION STANDARD

TS ISO 17885

ÇAP / SIZE Ø20 - Ø110

YENİ / NEW

YEŞİL SERİ
GREEN SERIES

PN 10



Kaplin Redüksiyon Manşon
Reducing Coupling

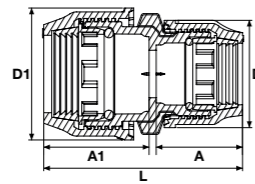

Çap Dia	Basınç Pn	Kod Code	Fiyat (Adet) Price (Pcs)	Koli Adet Box Pcs	Poşet İçi Adet Bag Pcs	A1 (mm)	D1 (mm)	A (mm)	D (mm)	L (mm)
25x20	10	GR70001600	0,92 €	350	25	36,5	46	34,2	37,5	73,7
32x20	10	GR70001601	1,21 €	270	10	43,6	56,5	34,2	37,5	80,8
32x25	10	GR70001602	1,21 €	220	10	43,6	56,5	36,5	46	83,1
40x20	10	GR70001603	1,68 €	140	10	49,2	68	34,2	37,5	86,4
40x25	10	GR70001604	1,68 €	140	10	49,2	68	36,5	46	88,7
40x32	10	GR70001605	1,68 €	120	10	49,2	68	43,6	56,5	95,8
50x25	10	GR70001606	2,48 €	96	6	59,2	84,4	36,5	46	98,7
50x32	10	GR70001607	2,70 €	90	6	59,2	84,4	43,6	56,5	105,8
50x40	10	GR70001608	2,82 €	78	6	59,2	84,4	49,2	68	111,4
63x25	10	GR70001609	3,51 €			69,4	101,8	36,5	46	111,9
63x32	10	GR70001610	3,81 €	72	6	69,4	101,8	43,6	56,5	119
63x40	10	GR70001611	3,81 €	60	6	69,4	101,8	49,2	68	124,6
63x50	10	GR70001612	3,81 €	48	6	69,4	101,8	59,2	84,4	134,6
75x50	10	GR70001613	①	32	2	111,6	118,8	59,2	84,4	176,8
75x63	10	GR70001614	①	28	2	111,6	118,8	69,4	101,8	187
90x63	10	GR70001615	①	20	2	124,9	139,6	69,4	101,8	200,3
90x75	10	GR70001616	①	16	2	124,9	139,6	111,6	118,8	242,5
110x75	10	GR70001618	①	12	1	144,5	164,2	111,6	118,8	262,1
110x90	10	GR70001619	①	10	1	144,5	164,2	124,9	139,6	275,4

Adaptör Sıkma Anahtarı
Adapter Key

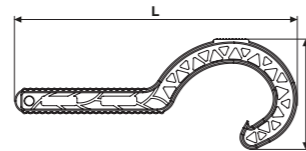

Çap Dia	Kod Code	Fiyat (Adet) Price (Pcs)	Çuval Adet Sack Pcs	Poşet İçi Adet Bag Pcs	L (mm)	h (mm)
20x25x32	EX70003000	2,78 €	700		236	92
40x50x63x75	EX70003001	7,80 €	230		338	112,5
90x110	EX70003002	9,88 €	50		456	151,5

Kaplin Te
Tee

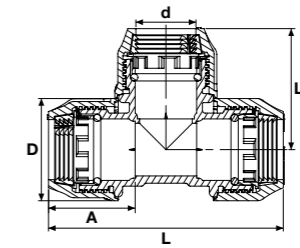

Çap Dia	Basınç Pn	Kod Code	Fiyat (Adet) Price (Pcs)	Koli Adet Box Pcs	Poşet İçi Adet Bag/Pcs	D (mm)	A (mm)	L (mm)	L1 (mm)
20x20x20	10	GR70001300	1,10 €	240	15	37,5	34,2	90,4	45,2
25x25x25	10	GR70001301	1,36 €	150	10	46	36,5	100	50
32x32x32	10	GR70001302	1,87 €	100	5	56,5	43,6	122,2	61,1
40x40x40	10	GR70001303	2,98 €	50	5	68	49,2	141,4	70,7
50x50x50	10	GR70001304	4,54 €	36	4	84,4	59,2	171,4	85,7
63x63x63	10	GR70001305	5,54 €	24	3	101,8	69,4	204,8	102,4
75x75x75	10	GR70001306	①	11	1	118,8	111,6	310,2	155,1
90x90x90	10	GR70001307	①	8	1	139,6	124,9	355,8	177,9
110x110x110	10	GR70001308	①	4	1	164,2	144,5	409	204,5

Kaplin Redüksiyon Te
Reducing Tee

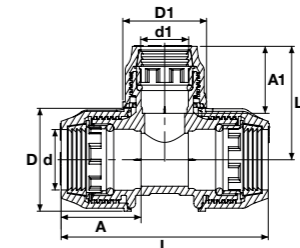

Çap Dia	Basınç Pn	Kod Code	Fiyat (Adet) Price (Pcs)	Koli Adet Box Pcs	Poşet İçi Adet Bag Pcs	A (mm)	D (mm)	A1 (mm)	D1 (mm)	L (mm)	L1 (mm)
25x20x25	10	GR70001700	1,39 €	190	10	36,5	46	34,2	37,5	96,6	52,45
32x20x32	10	GR70001701	1,93 €	120	5	43,6	56,5	34,2	37,5	110,8	59,7
32x25x32	10	GR70001702	1,93 €	110	5	43,6	56,5	36,5	46	113,2	62
40x25x40	10	GR70001703	2,98 €	65	5	49,2	68	36,5	46	124,4	65,6
40x32x40	10	GR70001704	3,02 €	60	5	49,2	68	43,6	56,5	131,4	72,7
50x25x50	10	GR70001705	3,97 €	48	4	59,2	84,4	36,5	46	144,4	75,2
50x32x50	10	GR70001706	4,26 €	48	4	59,2	84,4	43,6	56,5	151,4	82,3
50x40x50	10	GR70001707	4,54 €	40	4	59,2	84,4	49,2	68	159,4	85,9
63x25x63	10	GR70001708	5,78 €			69,4	101,8	36,5	46	164,8	81,6
63x32x63	10	GR70001709	5,78 €	30	3	69,4	101,8	43,6	56,5	171,8	88,7
63x40x63	10	GR70001710	6,31 €	27	3	69,4	101,8	49,2	68	179,8	93,3
63x50x63	10	GR70001711	6,60 €	24	3	69,4	101,8	59,2	84,4	188,5	102,3

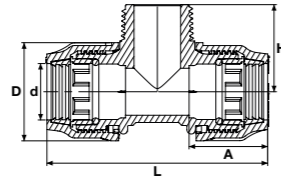
Kaplin Erkek Te
 Male Tee

Çap Dia	Basınç Pn	Kod Code	Fiyat (Adet) Price (Pcs)	Koli Adet Box Pcs	Poşet İçi Adet Bag/Pcs	D (mm)	A (mm)	L (mm)	H (mm)
20x1/2"x20	10	GR70001900	0,91 €	300	15	37,5	34,2	84,4	34,5
20x3/4"x20	10	GR70001901	0,91 €	300	15	37,5	34,2	89,4	35,5
20x1"x20	10	GR70001929	0,91 €			37,5	34,2	98,2	37,5
25x1/2"x25	10	GR70001902	1,23 €	210	10	46	36,5	91,34	37,8
25x3/4"x25	10	GR70001903	1,20 €	200	10	46	36,5	96,64	38,8
25x1"x25	10	GR70001904	1,22 €	200	10	46	36,5	102,8	40,8
25x1 1/4"x25	10	GR70001905	1,38 €	140	10	46	36,5	111,28	43,8
32x1/2"x32	10	GR70001906	1,39 €	140	10	56,5	43,6	105,54	43,5
32x3/4"x32	10	GR70001907	1,68 €	140	10	56,5	43,6	107,2	43,5
32x1"x32	10	GR70001908	1,68 €	130	10	56,5	43,6	116,2	47,5
32x1 1/4"x32	10	GR70001909	1,90 €	120	10	56,5	43,6	125,48	49,5
40x1"x40	10	GR70001910	2,46 €	70	5	68	49,2	118,4	54
40x1 1/4"x40	10	GR70001911	2,46 €	70	5	68	49,2	136,7	56
40x1 1/2"x40	10	GR70001912	2,46 €	60	5	68	49,2	139,4	58
50x1"x50	10	GR70001913	3,67 €	48	4	84,4	59,2	140,4	60
50x1 1/4"x50	10	GR70001914	3,79 €	48	4	84,4	59,2	152,4	62
50x1 1/2"x50	10	GR70001915	3,89 €	44	4	84,4	59,2	154,4	64
50x2"x50	10	GR70001916	3,89 €	36	4	84,4	59,2	166,4	66
63x1 1/4"x63	10	GR70001917	5,29 €	30	3	101,8	69,4	167,8	69
63x1 1/2"x63	10	GR70001918	5,43 €	30	3	101,8	69,4	168,8	71
63x2"x63	10	GR70001919	5,43 €	27	3	101,8	69,4	181,8	74,5
63x2 1/2"x63	10	GR70001920	5,94 €	24	3	101,8	69,4	190,8	78,9
75x2"x75	10	GR70001921	Ⓟ	18	1	118,8	111,6	283,2	83
75x2 1/2"x75	10	GR70001922	Ⓟ	16	1	118,8	111,6	298,2	87
75x3"x75	10	GR70001923	Ⓟ	13	1	118,8	111,6	306,2	89
90x2 1/2"x90	10	GR70001924	Ⓟ	10	1	139,6	124,9	324,8	93
90x3"x90	10	GR70001925	Ⓟ	9	1	139,6	124,9	337,8	95
90x4"x90	10	GR70001926	Ⓟ	9	1	139,6	124,9	363,8	106,3
110x3"x110	10	GR70001927	Ⓟ	6	1	164,2	144,5	375	105
110x4"x110	10	GR70001928	Ⓟ	7	1	164,2	144,5	399	110,3

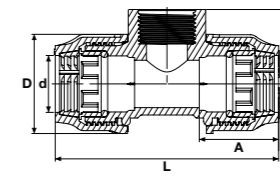
Kaplin Dişi Te
 Female Tee

Çap Dia	Basınç Pn	Kod Code	Fiyat (Adet) Price (Pcs)	Koli Adet Box Pcs	Poşet İçi Adet Bag Pcs	D (mm)	A (mm)	L (mm)	H (mm)
20x1/2"x20	10	GR70002300	0,91 €	270	15	37,5	34,2	92,4	29,2
20x3/4"x20	10	GR70002301	0,91 €	270	15	37,5	34,2	98,4	31,7
25x1/2"x25	10	GR70002302	1,23 €	200	10	46	36,5	97	32
25x3/4"x25	10	GR70002303	1,20 €	180	10	46	36,5	103	34,5
25x1"x25	10	GR70002304	1,22 €	180	10	46	36,5	111	40
32x1/2"x32	10	GR70002305	1,39 €	140	10	56,5	43,6	111,2	35,6
32x3/4"x32	10	GR70002306	1,68 €	130	10	56,5	43,6	117,2	38,1
32x1"x32	10	GR70002307	1,68 €	120	10	56,5	43,6	125,2	43,6
40x3/4"x40	10	GR70002308	2,46 €	70	5	68	49,2	128,4	41,3
40x1"x40	10	GR70002309	2,46 €	70	5	68	49,2	132,4	46,8
40x1 1/4"x40	10	GR70002310	2,46 €	60	5	68	49,2	140,4	48,8
50x1"x50	10	GR70002311	3,67 €	48	4	84,4	59,2	150,4	50,9
50x1 1/4"x50	10	GR70002312	3,79 €	44	4	84,4	59,2	160,4	52,9
50x1 1/2"x50	10	GR70002313	3,89 €	44	4	84,4	59,2	166,8	53,9
63x1 1/4"x63	10	GR70002314	5,29 €	27	3	101,8	69,4	172,8	58,3
63x1 1/2"x63	10	GR70002315	5,43 €	27	3	101,8	69,4	175,8	59,3
63x2"x63	10	GR70002316	5,43 €	27	3	101,8	69,4	190,8	62
75x2"x75	10	GR70002317	Ⓟ	18	1	118,8	111,6	287,2	88
75x2 1/2"x75	10	GR70002318	Ⓟ	15	1	118,8	111,6	302,2	92
75x3"x75	10	GR70002319	Ⓟ	12	1	118,8	111,6	304,2	97
90x2 1/2"x90	10	GR70002320	Ⓟ	10	1	139,6	124,9	330,8	101
90x4"x90	10	GR70002321	Ⓟ	10	1	139,6	124,9	345,8	103,5
90x4"x90	10	GR70002322	Ⓟ	9	1	139,6	124,9	359,8	112
110x3"x110	10	GR70002323	Ⓟ	6	1	164,2	144,5	387	117,5
110x4"x110	10	GR70002324	Ⓟ	5	1	164,2	144,5	402	126

Not / Note

PP

VANA KUTULARI VALVE BOXES

ÜRETİM STANDARDI
PRODUCTION STANDARD | TS 13716

ÇAP / SIZE Ø6" - Ø16"



Vana Kutusu
Valve Box



Çap Dia	Kod Code	Fiyat (Adet) Price (Pcs)	Palet/Adet Pallet/Pcs
6"	EX70003400	3,78 €	600

Vana Kutusu
Valve Box



Çap Dia	Kod Code	Fiyat (Adet) Price (Pcs)	Palet/Adet Pallet/Pcs
10"	EX70003401	6,71 €	300

Vana Kutusu
Valve Box (Standard)



Çap Dia	Kod Code	Fiyat (Adet) Price (Pcs)	Palet/Adet Pallet/Pcs
12"	EX70003500	12,21 €	168

Vana Kutusu
Valve Box (Jumbo)



Çap Dia	Kod Code	Fiyat (Adet) Price (Pcs)	Palet/Adet Pallet/Pcs
14"	EX70003501	16,54 €	116

Vana Kutusu
Vana Kutusu (Maxi Jumbo)



Çap Dia	Kod Code	Fiyat (Adet) Price (Pcs)	Palet/Adet Pallet/Pcs
16"	EX70003502	①	100

U-PVC

PRİZ KOLYELER

CLAMP SADDLES

ÜRETİM STANDARDI
PRODUCTION STANDARD | TS ISO 13460-1

ÇAP / SIZE Ø20 - Ø110

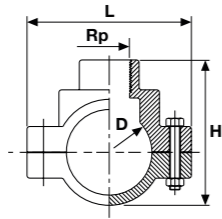

UH-PVC Priz Kolye
 UH-PVC Clamp Saddle (4 Bolts)

D (mm)	Rp Inch	Basınç PN	Kod Code	Fiyat (Adet) Price (Pcs)	Kg /Adet Kg/Pcs	Koli/Adet Box/Pcs	L (mm)	H (mm)
25	1/2"	16	52900250204	0,99 €	0,17	150	54	77
32	1/2"	16	52900320204	1,06 €	0,21	140	65	82
32	3/4"	16	52900320254	1,07 €	0,21	140	65	82
40	1/2"	16	52900400204	1,12 €	0,25	130	74	82
40	3/4"	16	52900400254	1,14 €	0,25	130	74	82
40	1"	16	52900400324	1,18 €	0,25	130	74	82
50	1/2"	16	52900500204	1,30 €	0,27	40	84	85
50	3/4"	16	52900500254	1,32 €	0,27	40	84	85
50	1"	16	52900500324	1,33 €	0,27	40	84	85
63	1/2"	16	52900630202	4,03 €	0,56	30	120	106
63	3/4"	16	52900630252	4,14 €	0,55	30	120	106
63	1"	16	52900630322	4,26 €	0,55	30	120	106
75	1/2"	16	52900750202	5,29 €	0,64	30	133	118
75	3/4"	16	52900750252	5,46 €	0,63	30	133	118
75	1"	16	52900750322	5,69 €	0,63	30	133	118
90	1/2"	16	52900900202	7,28 €	0,76	24	148	140
90	3/4"	16	52900900252	7,41 €	0,75	24	148	140
90	1"	16	52900900322	7,61 €	0,75	24	148	140
110	1/2"	16	52900110204	9,23 €	0,96	18	170	160
110	3/4"	16	51300110254	9,36 €	0,96	18	170	160
110	1"	16	51300110325	9,55 €	0,95	18	170	160

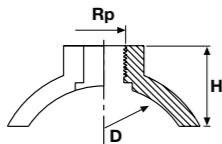
UH-PVC Biberon Kolye
 UH-PVC Clamp Saddle With Hose Adaptor

D (mm)	R Inch	Basınç PN	Kod Code	Fiyat (Adet) Price (Pcs)	Kg /Adet Kg/Pcs	Koli/Adet Box/Pcs	H (mm)
63	1/2"	16	53000630202	2,13 €	0,04	100	39
63	3/4"	16	53000630252	2,19 €	0,04	100	39
63	1"	16	53000630322	2,24 €	0,17	100	39
90	1/2"	16	53000900202	2,53 €	0,07	100	41
90	3/4"	16	53000900252	2,59 €	0,14	100	41
90	1"	16	53000900322	2,70 €	0,07	100	41

PP

PRİZ KOLYELER

CLAMP SADDLES

ÜRETİM STANDARDI
 PRODUCTION STANDARD | TS ISO 13460-1

ÇAP / SIZE Ø20 - Ø110



PP Priz Kolye
PP Clamp Saddle

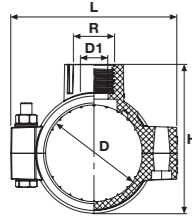

D (mm)	R (mm)	Basınc Pn	Kod Code	Fiyat (Adet) Price (Pcs)	Koli Adet Box Pcs	Poşet İçi Adet Bag/Pcs	d1 (mm)	L (mm)	H (mm)
25	1/2"	16	EX52901250202	0,69 €	180	1	16	54	52
25	3/4"	16	EX52901250252	0,69 €	180				
32	1/2"	16	EX52901320202	0,61 €	140	1	16	78	62
32	3/4"	16	EX52901320252	0,89 €	140	1	21	78	62
40	1/2"	16	EX52901400202	1,02 €	130	1	16	80	68
40	3/4"	16	EX52901400252	1,02 €	130	1	21	80	68
40	1"	16	EX52901400322	1,02 €	130	1	27	80	68
50	1/2"	16	EX52901500202	1,19 €	120	1	16	84	81
50	3/4"	16	EX52901500252	1,19 €	120	1	21	84	81
50	1"	16	EX52901500322	1,26 €	120	1	27	84	81
63	1/2"	16	EX52901630202	1,80 €	50	1	16	98	93
63	3/4"	16	EX52901630252	1,42 €	50	1	21	98	93
63	1"	16	EX52901630322	1,57 €	50	1	27	98	93
63	1 1/4"	16	EX52901630402	2,16 €			35	98	93
63	1 1/2"	16	EX52901630502	2,19 €			42	98	93
75	1/2"	16	EX52901750202	2,09 €	35	1	16	117	102
75	3/4"	16	EX52901750252	2,09 €	35	1	21	117	104
75	1"	16	EX52901750322	2,09 €	35	1	27	117	107
75	1 1/4"	16	EX52901750402	2,50 €	35	1	35	117	109
75	1 1/2"	16	EX52901750502	2,59 €	30	1	42	117	109
75	2"	16	EX52901750632	2,83 €	30	1	53	117	111
90	1/2"	16	EX52901900202	2,43 €	25	1	16	128	116
90	3/4"	16	EX52901900252	2,49 €	25	1	21	128	118
90	1"	16	EX52901900322	2,49 €	25	1	27	128	121
90	1 1/4"	16	EX52901900402	2,87 €	25	1	35	128	123
90	1 1/2"	16	EX52901900502	2,90 €	25	1	42	128	123
90	2"	16	EX52901900632	3,13 €	25	1	53	128	126
110	1/2"	16	EX52901110202	2,79 €	20	1	15	146	150
110	3/4"	16	EX52901110252	2,81 €	20	1	20	146	150
110	1"	16	EX52901110322	2,81 €	20	1	26	146	150
110	1 1/4"	16	EX52901110402	3,35 €	20	1	35	146	150
110	1 1/2"	16	EX52901110502	3,42 €	20	1	41	146	150
110	2"	16	EX52901110632	3,63 €	20	1	51	146	150
125	1/2"	16	EX52901125202	4,40 €	18	1	15	166	169
125	3/4"	16	EX52901125252	4,51 €	18	1	20	166	169
125	1"	16	EX52901125322	4,65 €	18	1	26	166	169
125	1 1/4"	16	EX52901125402	4,84 €	18	1	35	166	169
125	1 1/2"	16	EX52901125502	4,95 €	18	1	41	166	169
125	2"	16	EX52901125632	5,25 €	18	1	50	166	169
140	1/2"	16	EX52901140202	6,46 €	15	1	18	178	191
140	3/4"	16	EX52901140252	6,58 €	15	1	24	178	191
140	1"	16	EX52901140322	6,65 €	15	1	30	178	191
140	1 1/4"	16	EX52901140402	6,86 €	15	1	38	178	191
140	1 1/2"	16	EX52901140502	6,91 €	15	1	45	178	191
140	2"	16	EX52901140632	6,91 €	15	1	50	178	191
160	1/2"	16	EX52901160202	7,23 €	9	1	18	216	215
160	3/4"	16	EX52901160252	7,33 €	9	1	24	216	215
160	1"	16	EX52901160322	7,43 €	9	1	30	216	215
160	1 1/4"	16	EX52901160402	7,64 €	9	1	38	216	215
160	1 1/2"	16	EX52901160502	7,74 €	9	1	45	216	215
160	2"	16	EX52901160632	7,90 €	9	1	50	216	215
200	3/4"	16	EX52901200252	15,06 €			24	262	245
200	1"	16	EX52901200322	15,15 €			30	262	245
200	1 1/4"	16	EX52901200402	15,26 €			38	262	245
200	1 1/2"	16	EX52901200502	15,40 €	9	1	45	262	245
200	2"	16	EX52901200632	15,63 €	9	1	50	262	245

PP Metal Yüzlüklü Priz Kolye
PP Clamp Saddle with Reinforcing Ring

YENİ / NEW

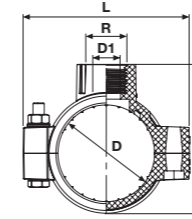

D (mm)	R (mm)	Basınc Pn	Kod Code	Fiyat (Adet) Price (Pcs)	Koli Adet Box Pcs	Poşet İçi Adet Bag/Pcs	d1 (mm)	L (mm)	H (mm)
25	1/2"	16	EX57700025202	0,78 €	180	1	16	54	52
25	3/4"	16	EX57700025252	0,78 €	180				
32	1/2"	16	EX57700032202	0,68 €	140	1	16	78	62
32	3/4"	16	EX57700032252	1,00 €	140	1	21	78	62
40	1/2"	16	EX57700040202	1,15 €	130	1	16	80	68
40	3/4"	16	EX57700040252	1,15 €	130	1	21	80	68
40	1"	16	EX57700040322	1,15 €	130	1	27	80	68
50	1/2"	16	EX57700050202	1,34 €	120	1	16	84	81
50	3/4"	16	EX57700050252	1,34 €	120	1	21	84	81
50	1"	16	EX57700050322	1,42 €	120	1	27	84	81
63	1/2"	16	EX57700063202	2,03 €	50	1	16	98	93
63	3/4"	16	EX57700063252	1,60 €	50	1	21	98	93
63	1"	16	EX57700063322	1,76 €	50	1	27	98	93
63	1 1/4"	16	EX57700063402	2,43 €			35	98	93
63	1 1/2"	16	EX57700063502	2,46 €			42	98	93
75	1/2"	16	EX57700075202	2,35 €	35	1	16	117	102
75	3/4"	16	EX57700075252	2,35 €	35	1	21	117	104
75	1"	16	EX57700075322	2,35 €	35	1	27	117	107
75	1 1/4"	16	EX57700075402	2,82 €	35	1	35	117	109
75	1 1/2"	16	EX57700075502	2,91 €	30	1	42	117	109
75	2"	16	EX57700075632	3,18 €	30	1	53	117	111
90	1/2"	16	EX57700090202	2,74 €	25	1	16	128	116
90	3/4"	16	EX57700090252	2,80 €	25	1	21	128	118
90	1"	16	EX57700090322	2,80 €	25	1	27	128	121
90	1 1/4"	16	EX57700090402	3,23 €	25	1	35	128	123
90	1 1/2"	16	EX57700090502	3,26 €	25	1	42	128	123
90	2"	16	EX57700090632	3,52 €	25	1	53	128	126
110	1/2"	16	EX57700110202	3,13 €	20	1	15	146	150
110	3/4"	16	EX57700110252	3,16 €	20	1	20	146	150
110	1"	16	EX57700110322	3,16 €	20	1	26	146	150
110	1 1/4"	16	EX57700110402	3,77 €	20	1	35	146	150
110	1 1/2"	16	EX57700110502	3,85 €	20	1	41	146	150
110	2"	16	EX57700110632	4,09 €	20	1	51	146	150
125	1/2"	16	EX57700125202	4,94 €	18	1	15	166	169
125	3/4"	16	EX57700125252	5,08 €	18	1	20	166	169
125	1"	16	EX57700125322	5,24 €	18	1	26	166	169
125	1 1/4"	16	EX57700125402	5,45 €	18	1	35	166	169
125	1 1/2"	16	EX57700125502	5,57 €	18	1	41	166	169
125	2"	16	EX57700125632	5,90 €	18	1	50	166	169
140	1/2"	16	EX57700140202	7,26 €	15	1	18	178	191
140	3/4"	16	EX57700140252	7,41 €	15	1	24	178	191
140	1"	16	EX57700140322	7,48 €	15	1	30	178	191
140	1 1/4"	16	EX57700140402	7,72 €	15	1	38	178	191
140	1 1/2"	16	EX57700140502	7,78 €	15	1	45	178	191
140	2"	16	EX57700140632	7,78 €	15	1	50	178	191
160	1/2"	16	EX57700160202	8,13 €	9	1	18	216	215
160	3/4"	16	EX57700160252	8,24 €	9	1	24	216	215
160	1"	16	EX57700160322	8,36 €	9	1	30	216	215
160	1 1/4"	16	EX57700160402	8,60 €	9	1	38	216	215
160	1 1/2"	16	EX57700160502	8,71 €	9	1	45	216	215
160	2"	16	EX57700160632	8,88 €	9	1	50	216	215
200	3/4"	16	EX57700200252	16,94 €			24	262	245
200	1"	16	EX57700200322	17,05 €			30	262	245
200	1 1/4"	16	EX57700200402	17,16 €			38	262	245
200	1 1/2"	16	EX57700200502	17,33 €	9	1	45	262	245
200	2"	16	EX57700200632	17,58 €	9	1	50	262	245

PP Çift Çıkışlı Civatalı Priz Kolye

PP Both Sides Socketed Clamp Saddle With Screws

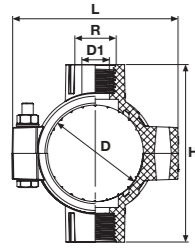

D (mm)	R (mm)	R1 (mm)	Basınç Pn	Kod Code	Fiyat (Adet) Price (Pcs)	Koli Adet Box Pcs	Poşet İçi Adet Bag/Pcs	L (mm)	H (mm)
25	1/2"	1/2"	16	EX52911025020202	0,81 €			54	52
25	3/4"	3/4"	16	EX52911025025202	0,81 €				
32	1/2"	1/2"	16	EX52911032020202	0,88 €	140	1	54	52
32	3/4"	3/4"	16	EX52911032025252	1,05 €	140		54	82
40	1/2"	1/2"	16	EX52911040020202	1,15 €	130	1	78	82
40	3/4"	3/4"	16	EX52911040025252	1,15 €	130	1	80	88
40	1"	1"	16	EX52911040032322	1,15 €	130	1	80	88
50	1/2"	1/2"	16	EX52911050020202	1,36 €	120	1	80	88
50	3/4"	3/4"	16	EX52911050025252	1,36 €	120	1	84	101
50	1"	1"	16	EX52911050032322	1,37 €	120	1	84	101
63	1/2"	1/2"	16	EX52911063020202	2,06 €	50	1	98	114
63	3/4"	3/4"	16	EX52911063025252	2,07 €	50	1	98	114
63	1"	1"	16	EX52911063032322	2,07 €	50	1	98	114
63	1 1/4"	1 1/4"	16	EX52911063040402	2,58 €			98	114
63	1 1/2"	1 1/2"	16	EX52911063050502	2,58 €			117	117
75	1/2"	1/2"	16	EX52911075020202	2,26 €	35	1	117	118
75	3/4"	3/4"	16	EX52911075025252	2,42 €	35	1	117	129
75	1"	1"	16	EX52911075032322	2,54 €	35	1	117	129
75	1 1/4"	1 1/4"	16	EX52911075040402	2,93 €	35	1	117	129
75	1 1/2"	1 1/2"	16	EX52911075050502	2,93 €	35	1	117	129
75	2"	2"	16	EX52911075063632	3,42 €	30	1	117	111
90	1/2"	1/2"	16	EX52911090020202	2,44 €	25	1	128	131
90	3/4"	3/4"	16	EX52911090025252	2,56 €	25	1	128	134
90	1"	1"	16	EX52911090032322	2,60 €	25	1	128	141
90	1 1/4"	1 1/4"	16	EX52911090040402	3,25 €	25	1	128	143
90	1 1/2"	1 1/2"	16	EX52911090050502	3,28 €	25	1	128	143
90	2"	2"	16	EX52911090063632	3,73 €	25	1	128	146
110	1/2"	1/2"	16	EX52911110020202	2,82 €	20	1	146	173
110	3/4"	3/4"	16	EX52911110025252	3,02 €	20	1	146	173
110	1"	1"	16	EX52911110032322	3,14 €	20	1	146	173
110	1 1/4"	1 1/4"	16	EX52911110040402	3,74 €	20	1	146	173
110	1 1/2"	1 1/2"	16	EX52911110050502	3,80 €	20	1	146	173
110	2"	2"	16	EX52911110063632	4,19 €	20	1	146	173
125	1/2"	1/2"	16	EX52911125020202	4,17 €	18	1	166	193
125	3/4"	3/4"	16	EX52911125025252	4,51 €	18	1	166	193
125	1"	1"	16	EX52911125032322	4,51 €	18	1	166	193
125	1 1/4"	1 1/4"	16	EX52911125040402	4,88 €	18	1	166	193
125	1 1/2"	1 1/2"	16	EX52911125050502	5,07 €	18	1	166	193
125	2"	2"	16	EX52911125063632	5,54 €	18	1	166	193
140	1/2"	1/2"	16	EX52911140020202	6,12 €	15	1	178	216
140	3/4"	3/4"	16	EX52911140025252	6,23 €	15	1	178	216
140	1"	1"	16	EX52911140032322	6,36 €	15	1	178	216
140	1 1/4"	1 1/4"	16	EX52911140040402	6,79 €	15	1	178	216
140	1 1/2"	1 1/2"	16	EX52911140050502	6,93 €	15	1	178	216
140	2"	2"	16	EX52911140063632	7,40 €	15	1	178	216
160	1/2"	1/2"	16	EX52911160020202	6,61 €	9	1	216	230
160	3/4"	3/4"	16	EX52911160025252	6,79 €	9	1	216	230
160	1"	1"	16	EX52911160032322	6,95 €	9	1	216	230
160	1 1/4"	1 1/4"	16	EX52911160040402	7,31 €	9	1	216	230
160	1 1/2"	1 1/2"	16	EX52911160050502	7,53 €	9	1	216	230
160	2"	2"	16	EX52911160032632	7,89 €	9	1	216	230
200	3/4"	3/4"	16	EX52911120025252	14,18 €		1	262	230
200	1"	1"	16	EX52911120032322	14,36 €		1	262	230
200	1 1/4"	1 1/4"	16	EX52911120040402	14,68 €		1	262	230
200	1 1/2"	1 1/2"	16	EX52911120050502	14,85 €	9	1	262	230
200	2"	2"	16	EX52911120063632	15,20 €	9	1	262	230

PP Çift Çıkışlı Metal Yüzüklü Priz Kolye

PP Both Sides Socketed Clamp Saddle With Reinforcing Ring

YENİ / NEW

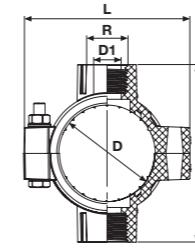

D (mm)	R (mm)	R1 (mm)	Basınç Pn	Kod Code	Fiyat (Adet) Price (Pcs)	Koli Adet Box Pcs	Poşet İçi Adet Bag/Pcs	L (mm)	H (mm)
25	1/2"	1/2"	16	EXBS57700025202	0,96 €	140		54	52
25	3/4"	3/4"	16	EXBS57700025252	0,91 €	140			
32	1/2"	1/2"	16	EXBS57700032202	0,99 €	130	1	54	52
32	3/4"	3/4"	16	EXBS57700032252	1,18 €	130		54	82
40	1/2"	1/2"	16	EXBS57700040202	1,29 €	130	1	78	82
40	3/4"	3/4"	16	EXBS57700040252	1,29 €	120	1	80	88
40	1"	1"	16	EXBS57700040322	1,29 €	120	1	80	88
50	1/2"	1/2"	16	EXBS57700050202	1,53 €	120	1	80	88
50	3/4"	3/4"	16	EXBS57700050252	1,53 €	50	1	84	101
50	1"	1"	16	EXBS57700050322	1,54 €	50	1	84	101
63	1/2"	1/2"	16	EXBS57700063202	2,32 €	50	1	98	114
63	3/4"	3/4"	16	EXBS57700063252	2,33 €		1	98	114
63	1"	1"	16	EXBS57700063322	2,33 €		1	98	114
63	1 1/4"	1 1/4"	16	EXBS57700063402	2,90 €	35		98	114
63	1 1/2"	1 1/2"	16	EXBS57700063502	2,90 €	35		117	117
75	1/2"	1/2"	16	EXBS57700075202	2,54 €	35	1	117	118
75	3/4"	3/4"	16	EXBS57700075252	2,73 €	35	1	117	129
75	1"	1"	16	EXBS57700075322	2,86 €	35	1	117	129
75	1 1/4"	1 1/4"	16	EXBS57700075402	3,30 €	30	1	117	129
75	1 1/2"	1 1/2"	16	EXBS57700075502	3,30 €	25	1	117	129
75	2"	2"	16	EXBS57700075632	3,85 €	25	1	117	111
90	1/2"	1/2"	16	EXBS57700090202	2,74 €	25	1	128	131
90	3/4"	3/4"	16	EXBS57700090252	2,88 €	25	1	128	134
90	1"	1"	16	EXBS57700090322	2,92 €	25	1	128	141
90	1 1/4"	1 1/4"	16	EXBS57700090402	3,65 €	25	1	128	143
90	1 1/2"	1 1/2"	16	EXBS57700090502	3,69 €	20	1	128	143
90	2"	2"	16	EXBS57700090632	4,20 €	20	1	128	146
110	1/2"	1/2"	16	EXBS57700110202	3,17 €	20	1	146	173
110	3/4"	3/4"	16	EXBS57700110252	3,40 €	20	1	146	173
110	1"	1"	16	EXBS57700110322	3,53 €	20	1	146	173
110	1 1/4"	1 1/4"	16	EXBS57700110402	4,21 €	20	1	146	173
110	1 1/2"	1 1/2"	16	EXBS57700110502	4,28 €	18	1	146	173
110	2"	2"	16	EXBS57700110632	4,72 €	18	1	146	173
125	1/2"	1/2"	16	EXBS57700125202	4,70 €	18	1	166	193
125	3/4"	3/4"	16	EXBS57700125252	5,07 €	18	1	166	193
125	1"	1"	16	EXBS57700125322	5,08 €	18	1	166	193
125	1 1/4"	1 1/4"	16	EXBS57700125402	5,49 €	18	1	166	193
125	1 1/2"	1 1/2"	16	EXBS57700125502	5,71 €	15	1	166	193
125	2"	2"	16	EXBS57700125632	6,23 €	15	1	166	193
140	1/2"	1/2"	16	EXBS57700140202	6,89 €	15	1	178	216
140	3/4"	3/4"	16	EXBS57700140252	7,00 €	15	1	178	216
140	1"	1"	16	EXBS57700140322	7,16 €	15	1	178	216
140	1 1/4"	1 1/4"	16	EXBS57700140402	7,64 €	15	1	178	216
140	1 1/2"	1 1/2"	16	EXBS57700140502	7,80 €	9	1	178	216
140	2"	2"	16	EXBS57700140632	8,33 €	9	1	178	216
160	1/2"	1/2"	16	EXBS57700160202	7,44 €	9	1	216	230
160	3/4"	3/4"	16	EXBS57700160252	7,64 €	9	1	216	230
160	1"	1"	16	EXBS57700160322	7,82 €	9	1	216	230
160	1 1/4"	1 1/4"	16	EXBS57700160402	8,22 €	9	1	216	230
160	1 1/2"	1 1/2"	16	EXBS57700160502	8,47 €		1	216	230
160	2"	2"	16	EXBS57700160632	8,88 €		1	216	230
200	3/4"	3/4"	16	EXBS57700200252	15,96 €		1	262	230
200	1"	1"	16	EXBS57700200322	16,15 €	9	1	262	230
200	1 1/4"	1 1/4"	16	EXBS57700200402	16,52 €	9	1	262	230
200	1 1/2"	1 1/2"	16	EXBS57700200502	16,71 €	6	1	262	230
200	2"	2"	16	EXBS57700200632	17,10 €	6	1	262	230

Kaplin Çıkışlı Priz Kolye
Coupling Outlet Clamp Saddle

YENİ / NEW

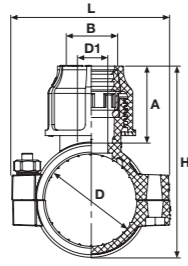

D (mm)	B (mm)	Basınç Pn	Kod Code	Fiyat (Adet) Price (Pcs)	Koli Adet Box Pcs	Poşet İçi Adet Bag Pcs	D1 (mm)	L (mm)	A (mm)	H (mm)
25	20	16	EX57800025202	0,84 €			15	69	37	71
25	25	16	EX57800025252	0,84 €			15	69	42	77
32	20	16	EX57800032202	0,82 €			15	69	37	80
32	25	16	EX57800032252	1,05 €			20	69	42	85
40	20	16	EX57800040202	1,46 €			15	70	37	88
40	25	16	EX57800040252	1,46 €			20	70	42	93
50	20	16	EX57800050202	1,78 €			15	86	37	102
50	25	16	EX57800050252	1,78 €			19	86	42	105
50	32	16	EX57800050322	1,84 €			25	86	47	111
63	20	16	EX57800063202	2,68 €			15	100	37	114
63	25	16	EX57800063252	2,35 €			20	100	42	119
63	32	16	EX57800063322	2,48 €			25	100	47	125
63	40	16	EX57800063402	2,98 €			32	100	59	137
75	20	16	EX57800075202	3,35 €			15	115	37	127
75	25	16	EX57800075252	3,35 €			20	115	42	133
75	32	16	EX57800075322	3,35 €			25	115	47	141
75	40	16	EX57800075402	3,70 €			32	115	59	155
75	50	16	EX57800075502	3,77 €			37	115	68	164
90	20	16	EX57800090202	4,74 €			15	132	37	145
90	25	16	EX57800090252	4,79 €			20	132	42	149
90	32	16	EX57800090322	4,79 €			25	132	47	157
90	40	16	EX57800090402	5,12 €			32	132	59	171
90	50	16	EX57800090502	5,14 €			40	132	68	180
110	20	16	EX57800110202	5,81 €			15	154	37	164
110	25	16	EX57800110252	5,83 €			20	154	42	168
110	32	16	EX57800110322	5,83 €			25	154	47	177
110	40	16	EX57800110402	6,29 €			32	154	59	190
110	50	16	EX57800110502	6,35 €			40	154	68	199

Çift Taraf Kaplin Çıkışlı Priz Kolye
Both Sides Coupling Outlet Clamp Saddle

YENİ / NEW

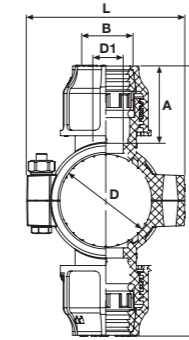

D (mm)	B (mm)	Basınç Pn	Kod Code	Fiyat (Adet) Price (Pcs)	Koli Adet Box Pcs	Poşet İçi Adet Bag/Pcs	D1 (mm)	L (mm)	A (mm)	H (mm)
25	20	16	EXBS57800025202	0,94 €			15	69	37	108,2
25	25	16	EXBS57800025252	0,94 €			15	69	42	118,7
32	20	16	EXBS57800032202	1,05 €			15	69	37	116,6
32	25	16	EXBS57800032252	1,19 €			20	69	42	127,1
40	20	16	EXBS57800040202	1,57 €			15	70	37	125,0
40	25	16	EXBS57800040252	1,57 €			20	70	42	135,5
50	20	16	EXBS57800050202	1,92 €			15	86	37	141,2
50	25	16	EXBS57800050252	1,92 €			19	86	42	146,7
50	32	16	EXBS57800050322	1,93 €			25	86	47	158,8
63	20	16	EXBS57800063202	2,90 €			15	100	37	151,7
63	25	16	EXBS57800063252	2,91 €			20	100	42	162,2
63	32	16	EXBS57800063322	2,91 €			25	100	47	172,8
63	40	16	EXBS57800063402	3,34 €			32	100	59	195,0
75	20	16	EXBS57800075202	3,49 €			15	115	37	162,2
75	25	16	EXBS57800075252	3,63 €			20	115	42	174,7
75	32	16	EXBS57800075322	3,73 €			25	115	47	188,3
75	40	16	EXBS57800075402	4,06 €			32	115	59	216,9
75	50	16	EXBS57800075502	4,06 €			37	115	68	234,9
90	20	16	EXBS57800090202	4,75 €			15	132	37	183,2
90	25	16	EXBS57800090252	4,85 €			20	132	42	191,7
90	32	16	EXBS57800090322	4,89 €			25	132	47	204,3
90	40	16	EXBS57800090402	5,44 €			32	132	59	233,9
90	50	16	EXBS57800090502	5,47 €			40	132	68	251,5
110	20	16	EXBS57800110202	5,84 €			15	154	37	202,2
110	25	16	EXBS57800110252	6,01 €			20	154	42	210,7
110	32	16	EXBS57800110322	6,11 €			25	154	47	224,8
110	40	16	EXBS57800110402	6,62 €			32	154	59	251,5
110	50	16	EXBS57800110502	6,67 €			40	154	68	269,5

Hortum Adaptör Çıkışlı Priz Kolye
 Hose Adaptor Outlet Clamp Saddle

YENİ / NEW

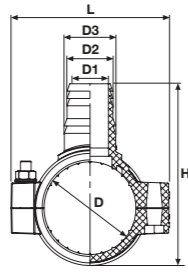

D (mm)	D2 (mm)	Basınç Pn	Kod Code	Fiyat (Adet) Price (Pcs)	Koli Adet Box Pcs	Poşet İçi Adet Bag Pcs	D1 (mm)	D3 (mm)	L (mm)	H (mm)
25	16	16	EX57900025162	0,67 €			12	18	69	61
25	20	16	EX57900025202	0,67 €			15	22	69	63
25	25	16	EX57900025252	0,67 €			20	28	69	70
32	16	16	EX57900032162	0,59 €			12	18	69	69
32	20	16	EX57900032202	0,59 €			15	22	69	71
32	25	16	EX57900032252	0,86 €			20	28	69	78
32	32	16	EX57900032322	0,86 €			25	34	69	85
40	16	16	EX57900040162	0,99 €			12	18	70	77
40	20	16	EX57900040202	0,99 €			15	22	70	79
40	25	16	EX57900040252	0,99 €			20	28	70	86
40	32	16	EX57900040322	0,99 €			25	34	70	93
50	16	16	EX57900050162	1,15 €			12	18	86	91
50	20	16	EX57900050202	1,15 €			15	22	86	92
50	25	16	EX57900050252	1,15 €			20	28	86	99
50	32	16	EX57900050322	1,23 €			25	34	85	106
63	16	16	EX57900063162	1,75 €			12	18	100	105
63	20	16	EX57900063202	1,75 €			15	22	100	106
63	25	16	EX57900063252	1,75 €			20	28	100	112
63	32	16	EX57900063322	1,75 €			25	34	100	120
75	16	16	EX57900075162	2,02 €			12	18	115	118
75	20	16	EX57900075202	2,02 €			15	22	115	120
75	25	16	EX57900075252	2,03 €			20	28	115	126
75	32	16	EX57900075322	2,03 €			25	34	115	137
90	16	16	EX57900090162	2,36 €			12	18	132	135
90	20	16	EX57900090202	2,36 €			15	22	132	136
90	25	16	EX57900090252	2,42 €			20	28	132	143
90	32	16	EX57900090322	2,42 €			25	34	132	151
110	16	16	EX57900110162	2,70 €			12	18	154	155
110	20	16	EX57900110202	2,70 €			15	22	154	157
110	25	16	EX57900110252	2,72 €			20	28	154	163
110	32	16	EX57900110322	2,72 €			25	34	154	173

Çift Taraf Hortum Adaptör Çıkışlı Priz Kolye
 Both Sides Hose Adaptor Outlet Clamp Saddle

YENİ / NEW

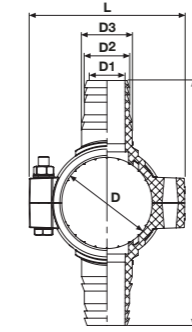

D (mm)	D2 (mm)	Basınç Pn	Kod Code	Fiyat (Adet) Price (Pcs)	Koli Adet Box Pcs	Poşet İçi Adet Bag/Pcs	D1 (mm)	D3 (mm)	L (mm)	H (mm)
25	16	16	EXBS57900025162	0,79 €			12	18	69	87
25	20	16	EXBS57900025202	0,79 €			15	22	69	91
25	25	16	EXBS57900025252	0,79 €			20	28	69	105
32	16	16	EXBS57900032162	0,85 €			12	18	69	95,4
32	20	16	EXBS57900032202	0,85 €			15	22	69	99,4
32	25	16	EXBS57900032252	1,02 €			20	28	69	113,4
32	32	16	EXBS57900032322	1,02 €			25	34	69	127,4
40	16	16	EXBS57900040162	1,11 €			12	18	70	103,8
40	20	16	EXBS57900040202	1,11 €			15	22	70	107,8
40	25	16	EXBS57900040252	1,11 €			20	28	70	121,8
40	32	16	EXBS57900040322	1,11 €			25	34	70	135,8
50	16	16	EXBS57900050162	1,32 €			12	18	86	119,0
50	20	16	EXBS57900050202	1,32 €			15	22	86	122,0
50	25	16	EXBS57900050252	1,32 €			20	28	86	136,0
50	32	16	EXBS57900050322	1,33 €			25	34	85	148,5
63	16	16	EXBS57900063162	2,00 €			12	18	100	133,0
63	20	16	EXBS57900063202	2,00 €			15	22	100	135,5
63	25	16	EXBS57900063252	2,01 €			20	28	100	147,0
63	32	16	EXBS57900063322	2,01 €			25	34	100	162,0
75	16	16	EXBS57900075162	2,19 €			12	18	115	145,0
75	20	16	EXBS57900075202	2,19 €			15	22	115	149,0
75	25	16	EXBS57900075252	2,35 €			20	28	115	161,5
75	32	16	EXBS57900075322	2,79 €			25	34	115	179,5
90	16	16	EXBS57900090162	2,68 €			12	18	132	163,2
90	20	16	EXBS57900090202	2,68 €			15	22	132	166,4
90	25	16	EXBS57900090252	2,81 €			20	28	132	179,0
90	32	16	EXBS57900090322	2,85 €			25	34	132	193,0
110	16	16	EXBS57900110162	3,10 €			12	18	154	183,5
110	20	16	EXBS57900110202	3,10 €			15	22	154	187,0
110	25	16	EXBS57900110252	3,32 €			20	28	154	199,5
110	32	16	EXBS57900110322	3,45 €			25	34	154	217,0

Geçmeli Priz Kolye
Click - Fit Clamp Saddle

YENİ / NEW

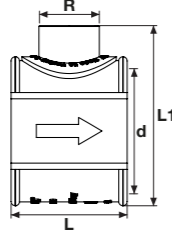

D (mm)	R (mm)	Basınç Pn	Kod Code	Fiyat (Adet) Price (Pcs)	Koli Adet Box Pcs	Poşet İçi Adet Bag/Pcs	L (mm)
32	1/2"	16	EX58000032202	0,72 €			47
32	3/4"	16	EX58000032252	1,00 €			47
40	1/2"	16	EX58000040202	1,06 €			47
40	3/4"	16	EX58000040252	1,08 €			47
50	1/2"	16	EX58000050202	1,79 €			68
50	3/4"	16	EX58000050252	1,78 €			68
50	1"	16	EX58000050322	1,78 €			68
63	1/2"	16	EX58000063202	1,83 €			69
63	3/4"	16	EX58000063252	1,83 €			69
63	1"	16	EX58000063322	1,82 €			69
75	1/2"	16	EX58000075202	2,34 €			69
75	3/4"	16	EX58000075252	2,35 €			69
75	1"	16	EX58000075322	2,37 €			69

Çift Taraf Geçmeli Priz Kolye
Both Sides Click - Fit Clamp Saddle

YENİ / NEW

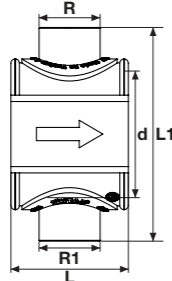

D (mm)	R (mm)	R1 (mm)	Basınç Pn	Kod Code	Fiyat (Adet) Price (Pcs)	Koli Adet Box Pcs	Poşet İçi Adet Bag/Pcs	L (mm)	L1 (mm)
32	1/2"	1/2"	16	EXBS58000032202	0,91 €			47	78,7
32	3/4"	3/4"	16	EXBS58000032252	0,94 €			47	78,7
40	1/2"	1/2"	16	EXBS58000040202	0,95 €			47	86,8
40	3/4"	3/4"	16	EXBS58000040252	0,97 €			47	86,8
50	1/2"	1/2"	16	EXBS58000050202	1,59 €			68	101,6
50	3/4"	3/4"	16	EXBS58000050252	1,58 €			68	102,6
50	1"	1"	16	EXBS58000050322	1,70 €			68	103,6
63	1/2"	1/2"	16	EXBS58000063202	1,63 €			69	105
63	3/4"	3/4"	16	EXBS58000063252	1,63 €			69	107
63	1"	1"	16	EXBS58000063322	1,74 €			69	115
75	1/2"	1/2"	16	EXBS58000075202	2,21 €			69	125,6
75	3/4"	3/4"	16	EXBS58000075252	2,22 €			69	125,6
75	1"	1"	16	EXBS58000075322	2,27 €			69	129,6

HDPE

MANDALLI YAĞ. BORU ve EK PARÇALARI

LATCHED IRRIGATION PIPE AND FITTINGS

ÜRETİM STANDARDI
PRODUCTION STANDARD

TS EN 12201-2+A1
TS EN 12201-3+A1

ÇAP / SIZE Ø32 - Ø160



Mandallı Yağmurlama Borusu
 Latched Irrigation Pipe

Çap Dia	Kod Code (5 m)	Fiyat (Adet) Price (Pcs)	Çap Dia	Kod Code (6 m)	Fiyat (Adet) Price (Pcs)
50	DRP99000001	⌚	50	DRP99000001 6	⌚
63	DRP99000002	⌚	63	DRP99000002 6	⌚
75	DRP99000003	⌚	75	DRP99000003 6	⌚
90	DRP99000004	⌚	90	DRP99000004 6	⌚
110	DRP99000005	⌚	110	DRP99000005 6	⌚
125	DRP99000006	⌚	125	DRP99000006 6	⌚
140	DRP99000007	⌚	140	DRP99000007 6	⌚
160	DRP99000008	⌚	160	DRP99000008 6	⌚

PE Mandallı Redüksiyon
 PE Latched Reducer

Çap Dia	Kod Code	Fiyat (Adet) Price (Pcs)
75x63	DRP10100001	⌚
90x63	DRP10100002	⌚
90x75	DRP10100003	⌚
110x63	DRP10100004	⌚
110x75	DRP10100005	⌚
110x90	DRP10100006	⌚
125x63	DRP10100007	⌚
125x75	DRP10100008	⌚
125x90	DRP10100009	⌚
125x110	DRP10100010	⌚
140x75	DRP10100011	⌚
140x90	DRP10100012	⌚
140x110	DRP10100013	⌚
140x125	DRP10100014	⌚
160x90	DRP10100015	⌚
160x110	DRP10100016	⌚
160x125	DRP10100017	⌚
160x140	DRP10100018	⌚

PE Mandallı Ters Redüksiyon
 PE Latched ? Reducer

Çap Dia	Kod Code	Fiyat (Adet) Price (Pcs)
75x63	DRP10200001	⌚
90x63	DRP10200002	⌚
90x75	DRP10200003	⌚
110x63	DRP10200004	⌚
110x75	DRP10200005	⌚
110x90	DRP10200006	⌚
125x63	DRP10200007	⌚
125x75	DRP10200008	⌚
125x90	DRP10200009	⌚
125x110	DRP10200010	⌚
140x75	DRP10200011	⌚
140x90	DRP10200012	⌚
140x110	DRP10200013	⌚
140x125	DRP10200014	⌚
160x90	DRP10200015	⌚
160x110	DRP10200016	⌚
160x125	DRP10200017	⌚
160x140	DRP10200018	⌚

PE Mandallı İstavroz
 PE Latched Cross Type

Çap Dia	Kod Code	Fiyat (Adet) Price (Pcs)
75x63	DRP95000000	⌚
75x75	DRP95000001	⌚
90x63	DRP95000002	⌚
90x75	DRP95000003	⌚
90x90	DRP95000004	⌚
110x50	DRP95000005	⌚
110x63	DRP95000006	⌚
110x75	DRP95000007	⌚
110x90	DRP95000008	⌚
110x110	DRP95000009	⌚
125x63	DRP95000011	⌚
125x75	DRP95000012	⌚
125x90	DRP95000013	⌚
125x110	DRP95000014	⌚
125x125	DRP95000015	⌚
140x75	DRP95000016	⌚
140x90	DRP95000017	⌚
140x110	DRP95000018	⌚
140x125	DRP95000019	⌚
140x140	DRP95000020	⌚
160x75	DRP95000021	⌚
160x90	DRP95000022	⌚
160x110	DRP95000023	⌚
160x125	DRP95000024	⌚
160x140	DRP95000025	⌚
160x160	DRP95000026	⌚

PE Mandallı Te
 PE Latched Tee

Çap Dia	Kod Code	Fiyat (Adet) Price (Pcs)
50x50	DRP96000027	⌚
63x63	DRP96000028	⌚
75x63	DRP96000029	⌚
75x75	DRP96000001	⌚
90x50	DRP96000030	⌚
90x63	DRP96000002	⌚
90x75	DRP96000003	⌚
90x90	DRP96000004	⌚
110x50	DRP96000005	⌚
110x63	DRP96000006	⌚
110x75	DRP96000007	⌚
110x90	DRP96000008	⌚
110x110	DRP96000009	⌚
125x50	DRP96000010	⌚
125x63	DRP96000011	⌚
125x75	DRP96000012	⌚
125x90	DRP96000013	⌚
125x110	DRP96000014	⌚
125x125	DRP96000015	⌚
140x75	DRP96000016	⌚
140x90	DRP96000017	⌚
140x110	DRP96000018	⌚
140x125	DRP96000019	⌚
140x140	DRP96000020	⌚
160x75	DRP96000021	⌚
160x90	DRP96000021	⌚
160x110	DRP96000023	⌚
160x125	DRP96000024	⌚
160x140	DRP96000025	⌚
160x160	DRP96000026	⌚

PE Mandallı Dirsek
 PE Latched Elbow

Çap Dia	Kod Code	Fiyat (Adet) Price (Pcs)
50	DRP97000001	⌚
63	DRP97000002	⌚
75	DRP97000003	⌚
90	DRP97000004	⌚
110	DRP97000005	⌚
125	DRP97000006	⌚
140	DRP97000007	⌚
160	DRP97000008	⌚

PE Mandallı Abot
 PE Latched Hydrant

Çap Dia	Kod Code	Fiyat (Adet) Price (Pcs)
50	DRP93000000	⌚
63	DRP93000001	⌚
75	DRP93000002	⌚
90	DRP93000003	⌚
110	DRP93000004	⌚

Küresel Hat Vanası
 Ball Line Valve

Çap Dia	Kod Code	Fiyat (Adet) Price (Pcs)
50	DRP76000001	⌚
63	DRP76000002	⌚
75	DRP76000003	⌚
90	DRP76000004	⌚
110	DRP76000005	⌚
125	DRP76000006	⌚

Yağmurlama Sprink Vanası
 Irrigation Sprink Valve

Çap Dia	Kod Code	Fiyat (Adet) Price (Pcs)
1"	240000322	⌚

PVC Uzatma Borusu

PVC Extension Pipe



Çap Dia (mm)	Uzunluk Length (cm)	Kod Code	Kod Code	Fiyat (Adet) Price (Pcs)
32	25	SD042156	DRP70000001	①
32	35	SD042157	DRP70000002	①
32	50	SD042158	DRP70000003	①
32	60	SD042159	DRP70000004	①
32	100	SD042160	DRP70000005	①
32	150	SD042161	DRP70000006	①

Sprinkler



Kod Code	Fiyat (Adet) Price (Pcs)
DRP75000001	①



Kod Code	Fiyat (Adet) Price (Pcs)
DRP73000001	①



Kod Code	Fiyat (Adet) Price (Pcs)
DRP72000001	①



Kod Code	Fiyat (Adet) Price (Pcs)
DRP71000001	①



Kod Code	Fiyat (Adet) Price (Pcs)
DRP74000001	①

Conta O-ring



Çap Dia	Kod Code	Fiyat (Adet) Price (Pcs)
50	DRP97000001	①
63	DRP97000002	①
75	DRP97000003	①
90	DRP97000004	①
110	DRP97000005	①
125	DRP97000006	①
140	DRP97000007	①
160	DRP97000008	①

PE

DAMLA SULAMA BORU

DRIP IRRIGATION PIPE

ÜRETİM STANDARDI

PRODUCTION STANDARD

TS EN ISO 9261

ÇAP / SIZE Ø16 - Ø25





16 mm Yuvarlak Damla Sulama Borusu

16 mm Round Drip Irrigation Pipes

Çap Dia (mm)	Kod Code	Fiyat (Adet) Price (Pcs)	Et Kalınlığı Wall Thickness (mm)	Damlaticı Aralığı Dropping Range (cm)	Mt/Adet Mt/Roll	Debi (L/h) Flow (L/h)
16	EXDRP79000001	Ⓜ	0,9	20	400	2/4/8
16	EXDRP79000002	Ⓜ	0,9	25	400	2/4/8
16	EXDRP79000003	Ⓜ	0,9	33	400	2/4/8
16	EXDRP79000004	Ⓜ	0,9	40	400	2/4/8
16	EXDRP79000005	Ⓜ	0,9	50	400	2/4/8
16	EXDRP79000006	Ⓜ	0,9	60	400	2/4/8
16	EXDRP79000007	Ⓜ	0,9	70	400	2/4/8
16	EXDRP79000008	Ⓜ	0,9	75	400	2/4/8
16	EXDRP79000009	Ⓜ	0,9	80	400	2/4/8
16	EXDRP79000010	Ⓜ	0,9	90	400	2/4/8
16	EXDRP79000011	Ⓜ	0,9	100	400	2/4/8

16 mm Yuvarlak Damla Sulama Borusu

16 mm Round Drip Irrigation Pipes

Çap Dia (mm)	Kod Code	Fiyat (Adet) Price (Pcs)	Et Kalınlığı Wall Thickness (mm)	Damlaticı Aralığı Dropping Range (cm)	Mt/Adet Mt/Roll	Debi (L/h) Flow (L/h)
16	EXDRP80000001	Ⓜ	1,0	20	400	2/4/8
16	EXDRP80000002	Ⓜ	1,0	25	400	2/4/8
16	EXDRP80000003	Ⓜ	1,0	33	400	2/4/8
16	EXDRP80000004	Ⓜ	1,0	40	400	2/4/8
16	EXDRP80000005	Ⓜ	1,0	50	400	2/4/8
16	EXDRP80000006	Ⓜ	1,0	60	400	2/4/8
16	EXDRP80000007	Ⓜ	1,0	70	400	2/4/8
16	EXDRP80000008	Ⓜ	1,0	75	400	2/4/8
16	EXDRP80000009	Ⓜ	1,0	80	400	2/4/8
16	EXDRP80000010	Ⓜ	1,0	90	400	2/4/8
16	EXDRP80000011	Ⓜ	1,0	100	400	2/4/8



Yuvarlak Düz Sulama Borusu

Straight Drip Irrigation Pipes

Çap Dia (mm)	Kod Code	Fiyat (Adet) Price (Pcs)	Et Kalınlığı Wall Thickness (mm)	Mt/Adet Mt/Roll
16	EXDRP81000001	Ⓜ	0,9	400
16	EXDRP81000002	Ⓜ	1,0	400
16	EXDRP81000003	Ⓜ	1,1	400
20	EXDRP81000004	Ⓜ	1,0	300
20	EXDRP81000005	Ⓜ	1,2	300
20	EXDRP81000006	Ⓜ	1,5	300
25	EXDRP81000007	Ⓜ	1,2	200
25	EXDRP81000008	Ⓜ	1,5	200
25	EXDRP81000009	Ⓜ	2,0	200

20 mm Yuvarlak Damla Sulama Borusu

20 mm Round Drip Irrigation Pipes

Çap Dia (mm)	Kod Code	Fiyat (Adet) Price (Pcs)	Et Kalınlığı Wall Thickness (mm)	Damlaticı Aralığı Dropping Range (cm)	Mt/Adet Mt/Roll	Debi (L/h) Flow (L/h)
20	EXDRP82000001	Ⓜ	1,1	20	300	2/4/8
20	EXDRP82000002	Ⓜ	1,1	25	300	2/4/8
20	EXDRP82000003	Ⓜ	1,1	33	300	2/4/8
20	EXDRP82000004	Ⓜ	1,1	40	300	2/4/8
20	EXDRP82000005	Ⓜ	1,1	50	300	2/4/8
20	EXDRP82000006	Ⓜ	1,1	60	300	2/4/8
20	EXDRP82000007	Ⓜ	1,1	70	300	2/4/8
20	EXDRP82000008	Ⓜ	1,1	75	300	2/4/8
20	EXDRP82000009	Ⓜ	1,1	80	300	2/4/8
20	EXDRP82000010	Ⓜ	1,1	90	300	2/4/8
20	EXDRP82000011	Ⓜ	1,1	100	300	2/4/8

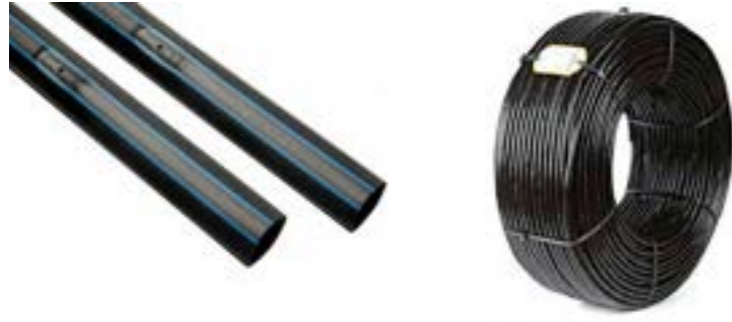

17 mm Yassı Damla Sulama Borusu (6 Mil)

17 mm Flat Drip Irrigation Pipes (6 Mil)

Çap Dia (mm)	Kod Code	Fiyat (Adet) Price (Pcs)	Et Kalınlığı Wall Thickness (mm)	Damlatıcı Aralığı Dropping Range (cm)	Mt/Adet Mt/Roll	Debi (L/h) Flow (L/h)
17	EXDRP83000001	①	0,15	20	2.500	1.6/2.2
17	EXDRP83000002	①	0,15	25	2.500	1.6/2.2
17	EXDRP83000003	①	0,15	33	2.500	1.6/2.2
17	EXDRP83000004	①	0,15	40	2.500	1.6/2.2
17	EXDRP83000005	①	0,15	50	2.500	1.6/2.2

17 mm Yassı Damla Sulama Borusu (8 Mil)

17 mm Flat Drip Irrigation Pipes (8 Mil)

Çap Dia (mm)	Kod Code	Fiyat (Adet) Price (Pcs)	Et Kalınlığı Wall Thickness (mm)	Damlatıcı Aralığı Dropping Range (cm)	Mt/Adet Mt/Roll	Debi (L/h) Flow (L/h)
17	EXDRP84000001	①	0,15	20	2.500	1.6/2.2
17	EXDRP84000002	①	0,15	25	2.500	1.6/2.2
17	EXDRP84000003	①	0,15	33	2.500	1.6/2.2
17	EXDRP84000004	①	0,15	40	2.500	1.6/2.2
17	EXDRP84000005	①	0,15	50	2.500	1.6/2.2

17 mm Yassı Damla Sulama Borusu (10 Mil)

17 mm Flat Drip Irrigation Pipes (10 Mil)

Çap Dia (mm)	Kod Code	Fiyat (Adet) Price (Pcs)	Et Kalınlığı Wall Thickness (mm)	Damlatıcı Aralığı Dropping Range (cm)	Mt/Adet Mt/Roll	Debi (L/h) Flow (L/h)
17	EXDRP85000001	①	0,25	20	1.800	1.6/2.2
17	EXDRP85000002	①	0,25	25	1.800	1.6/2.2
17	EXDRP85000003	①	0,25	33	1.800	1.6/2.2
17	EXDRP85000004	①	0,25	40	1.800	1.6/2.2
17	EXDRP85000005	①	0,25	50	1.800	1.6/2.2

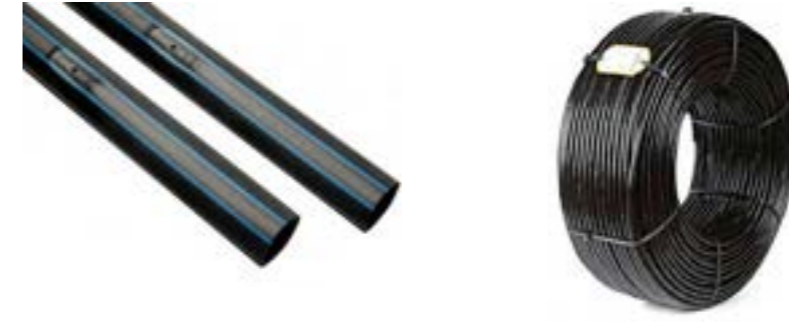

22 mm Yassı Damla Sulama Borusu (8 Mil)

22 mm Flat Drip Irrigation Pipes (8 Mil)

Çap Dia (mm)	Kod Code	Fiyat (Adet) Price (Pcs)	Et Kalınlığı Wall Thickness (mm)	Damlatıcı Aralığı Dropping Range (cm)	Mt/Adet Mt/Roll	Debi (L/h) Flow (L/h)
22	EXDRP86000001	①	0,20	20	1.800	1.6/2.2
22	EXDRP86000002	①	0,20	25	1.800	1.6/2.2
22	EXDRP86000003	①	0,20	33	1.800	1.6/2.2
22	EXDRP86000004	①	0,20	40	1.800	1.6/2.2
22	EXDRP86000005	①	0,20	50	1.800	1.6/2.2

22 mm Yassı Damla Sulama Borusu (12 Mil)

22 mm Flat Drip Irrigation Pipes (12 Mil)

Çap Dia (mm)	Kod Code	Fiyat (Adet) Price (Pcs)	Et Kalınlığı Wall Thickness (mm)	Damlatıcı Aralığı Dropping Range (cm)	Mt/Adet Mt/Roll	Debi (L/h) Flow (L/h)
22	EXDRP87000001	①	0,30	20	1.200	1.6/2.2
22	EXDRP87000002	①	0,30	25	1.200	1.6/2.2
22	EXDRP87000003	①	0,30	33	1.200	1.6/2.2
22	EXDRP87000004	①	0,30	40	1.200	1.6/2.2
22	EXDRP87000005	①	0,30	50	1.200	1.6/2.2

25 mm Yassı Damla Sulama Borusu (12 Mil)

25 mm Flat Drip Irrigation Pipes (12 Mil)

Çap Dia (mm)	Kod Code	Fiyat (Adet) Price (Pcs)	Et Kalınlığı Wall Thickness (mm)	Damlatıcı Aralığı Dropping Range (cm)	Mt/Adet Mt/Roll	Debi (L/h) Flow (L/h)
25	EXDRP88000001	①	0,30	20	1.000	1.6/2.2
25	EXDRP88000002	①	0,30	25	1.000	1.6/2.2
25	EXDRP88000003	①	0,30	33	1.000	1.6/2.2
25	EXDRP88000004	①	0,30	40	1.000	1.6/2.2
25	EXDRP88000005	①	0,30	50	1.000	1.6/2.2

Not / Note

PP

DAMLA SULAMA ÜRÜNLERİ DRIP IRRIGATION PRODUCT LINE

ÜRETİM STANDARDI
PRODUCTION STANDARD | TS EN ISO 9261

ÇAP / SIZE Ø16 - Ø110



Kurtağzı Mini Vana
Barbed Mini Valve

Çap Dia (mm)	Kod Code	Fiyat (Adet) Price (Pcs)	Koli Adet Box Pcs	Kg/Koli Kg/Box
16x16	DRP1000001	0,50 €	400	7,430
20x16	DRP1000002	0,53 €	350	6,900
20x20	DRP1000003	0,54 €	350	7,140

Kurtağzı Conta Çıkış Mini Vana
Barbed Offtake Mini Valve

Çap Dia (mm)	Kod Code	Fiyat (Adet) Price (Pcs)	Koli Adet Box Pcs	Kg/Koli Kg/Box
16x16	DRP2000001	0,52 €	400	8,000
20x20	DRP2000002	0,54 €	300	7,470

Kurtağzı Dış Dişli Mini Vana
Male Thread Barbed Mini Valve

Çap Dia (mm)	Kod Code	Fiyat (Adet) Price (Pcs)	Koli Adet Box Pcs	Kg/Koli Kg/Box
16x1/2"	DRP3000001	0,54 €	400	8,450
16x3/4"	DRP3000002	0,55 €	350	8,300
20x1/2"	DRP3000003	0,56 €	350	9,350
20x3/4"	DRP3000004	0,60 €	350	8,500

Kurtağzı Somunlu Mini Vana
Mini Valve Barbed For Tape & GR

Çap Dia (mm)	Kod Code	Fiyat (Adet) Price (Pcs)	Koli Adet Box Pcs	Kg/Koli Kg/Box
17x16	DRP4000001	0,64 €	300	7,450

Somunlu Dış Dişli Mini Vana
Male Thread Mini Valve -Tape & GR

Çap Dia (mm)	Kod Code	Fiyat (Adet) Price (Pcs)	Koli Adet Box Pcs	Kg/Koli Kg/Box
17x1/2"	DRP5000001	0,66 €	300	7,950
17x3/4"	DRP5000002	0,72 €	300	8,790

Somunlu Conta Çıkış Mini Vana
Mini Valve Offtake For Tape & GR

Çap Dia (mm)	Kod Code	Fiyat (Adet) Price (Pcs)	Koli Adet Box Pcs	Kg/Koli Kg/Box
17x16	DRP6000001	0,64 €	300	7,650

Kurtağzı Yüzüklü Mini Vana
Barbed Mini Valve With Ring

Çap Dia (mm)	Kod Code	Fiyat (Adet) Price (Pcs)	Koli Adet Box Pcs	Kg/Koli Kg/Box
17x16	DRP7000001	0,64 €	350	7,500

Yüzüklü Conta Çıkış Mini Vana
Mini Valve Offtake With Ring

Çap Dia (mm)	Kod Code	Fiyat (Adet) Price (Pcs)	Koli Adet Box Pcs	Kg/Koli Kg/Box
17x16	DRP8000001	0,78 €	350	7,900

Yüzüklü Contasız Bağlantı Mini Vana
Mini Valve With Ring (Without Gasket)

Çap Dia (mm)	Kod Code	Fiyat (Adet) Price (Pcs)	Koli Adet Box Pcs	Kg/Koli Kg/Box
17x12	DRP9000001	0,78 €	300	-

Somunlu Contasız Bağlantı Mini Vana
Mini Valve For Tape & GR (Without Ring)

Çap Dia (mm)	Kod Code	Fiyat (Adet) Price (Pcs)	Koli Adet Box Pcs	Kg/Koli Kg/Box
17x12	DRP10000001	0,65 €	250	7,850

Yüzüklü Dış Dişli Mini Vana
Mini Valve Thread Male - With Ring

Çap Dia (mm)	Kod Code	Fiyat (Adet) Price (Pcs)	Koli Adet Box Pcs	Kg/Koli Kg/Box
17x1/2"	DRP11000001	0,70 €	350	8,350
17x3/4"	DRP11000002	1,20 €	300	8,450

Yüzüklü Layflat Mini Vana
Mini Valve Layflat For Tape & GR

Çap Dia (mm)	Kod Code	Fiyat (Adet) Price (Pcs)	Koli Adet Box Pcs	Kg/Koli Kg/Box
17	DRP12000001	1,20 €	200	-

Somunlu Layflat Mini Vana
Mini Valve Layflat With Ring

Çap Dia (mm)	Kod Code	Fiyat (Adet) Price (Pcs)	Koli Adet Box Pcs	Kg/Koli Kg/Box
17	DRP13000001	1,20 €	200	-

Kurtağzı Layflat Mini Vana
Mini Valve Layflat Barbed

Çap Dia (mm)	Kod Code	Fiyat (Adet) Price (Pcs)	Koli Adet Box Pcs	Kg/Koli Kg/Box
16	DRP14000001	1,09 €	250	-

Yüzüklü Kurtağı Ekleme Nipeli

Tape (With Ring) Barbed



Çap Dia (mm)	Kod Code	Fiyat (Adet) Price (Pcs)	Koli Adet Box Pcs	Kg/Koli Kg/Box
17x16	DRP30000001	0,1	-	-
22x20	DRP30000002	0,1	-	-
25x20	DRP30000003	0,1	-	-

Somunlu Te

Dripline Tee



Çap Dia (mm)	Kod Code	Fiyat (Adet) Price (Pcs)	Koli Adet Box Pcs	Kg/Koli Kg/Box
20x20x20	DRP31000001	0,65 €	150	5,580
22x22x22	DRP31000002	0,79 €	150	7,850
25x25x25	DRP31000003	0,84 €	150	7,350

Somunlu Dış Dişli Dirsek

Dripline - Male Elbow



Çap Dia (mm)	Kod Code	Fiyat (Adet) Price (Pcs)	Koli Adet Box Pcs	Kg/Koli Kg/Box
17x1/2"	DRP32000001	0,25 €	300	4,500
22x1/2"	DRP32000002	0,29 €	250	4,600
25x1/2"	DRP32000003	0,30 €	250	5,200

Somunlu Conta Çıkış Te

Tape (With Ring) Grommet Tee



Çap Dia (mm)	Kod Code	Fiyat (Adet) Price (Pcs)	Koli Adet Box Pcs	Kg/Koli Kg/Box
17x16x17	DRP33000001	0,49 €	250	7,630
17x20x17	DRP33000002	0,49	-	-
20x20x20	DRP33000003	0,49	-	-
22x20x22	DRP33000004	0,62 €	200	6,900
25x20x25	DRP33000005	0,66 €	200	7,660

Yüzüklü Conta Çıkış Te

Tape (With Ring) Grommet Tee



Çap Dia (mm)	Kod Code	Fiyat (Adet) Price (Pcs)	Koli Adet Box Pcs	Kg/Koli Kg/Box
17x16x17	DRP34000001	0,48 €	250	5,250
17x20x17	DRP34000002	0,48 €	250	5,820
22x20x22	DRP34000003	0,55 €	200	6,150
25x20x25	DRP34000004	0,58 €	200	-

Somunlu Dış Dişli Te

Tape (With Ring) Male Tee



Çap Dia (mm)	Kod Code	Fiyat (Adet) Price (Pcs)	Koli Adet Box Pcs	Kg/Koli Kg/Box
17x1/2"x17	DRP35000001	0,48 €	250	6,150
22x1/2"x22	DRP35000002	0,55 €	200	8,650
25x1/2"x25	DRP35000003	0,58 €	200	9,560

Yüzüklü Dış Dişli Te

Dripline Male Tee



Çap Dia (mm)	Kod Code	Fiyat (Adet) Price (Pcs)	Koli Adet Box Pcs	Kg/Koli Kg/Box
17x1/2"x17	DRP36000001	0,49 €	250	5,950
22x1/2"x22	DRP36000002	0,64 €	250	7,400
25x1/2"x25	DRP36000003	0,66 €	200	-

Kanallı Conta

Barbed Grommet Gasket



Çap Dia (mm)	Kod Code	Fiyat (Adet) Price (Pcs)	Koli Adet Box Pcs	Kg/Koli Kg/Box
16	DRP37000001	0,10 €	3000	10,800
20	DRP37000002	0,11 €	2000	9,200
8	DRP37000003	0,1	-	-

Düz Conta

Barbed Grommet Gasket



Çap Dia (mm)	Kod Code	Fiyat (Adet) Price (Pcs)	Koli Adet Box Pcs	Kg/Koli Kg/Box
16	DRP38000001	0,11 €	3000	12,800
20	DRP38000002	0,12 €	2000	9,460

Kanallı Conta Tapa

Barbed Grommet End Cap Gasket



Çap Dia (mm)	Kod Code	Fiyat (Adet) Price (Pcs)	Koli Adet Box Pcs	Kg/Koli Kg/Box
16	DRP39000001	0,10 €	3000	10,450
20	DRP39000002	0,12 €	2000	11,350

3 mm Delici

3 mm Manuel Drilller



Çap Dia (mm)	Kod Code	Fiyat (Adet) Price (Pcs)	Koli Adet Box Pcs	Kg/Koli Kg/Box
3	DRP40000001	2,52 €	50	2,250

Kangal Delme Aparatı

Manuel Drilller



Çap Dia (mm)	Kod Code	Fiyat (Adet) Price (Pcs)	Koli Adet Box Pcs	Kg/Koli Kg/Box
16	DRP41000001	3,18 €	50	3,070
20	DRP41000002	3,18 €	50	3,300

Kangal Delme Aparatı (Matkap)

Driller



Çap Dia (mm)	Kod Code	Fiyat (Adet) Price (Pcs)	Koli Adet Box Pcs	Kg/Koli Kg/Box
16	DRP42000001	2,52 €	100	2,750
20	DRP42000002	2,88 €	100	3,500

PC Basınç Ayarlı Damlatıcı
PC Emitters



Çap Dia (mm)	Kod Code	Fiyat (Adet) Price (Pcs)	Koli Adet Box Pcs	Kg/Koli Kg/Box
2 L/h	DRP43000001	0,20 €	2500	10,150
4 L/h	DRP43000002	0,20 €	2500	10,410
8 L/h	DRP43000003	0,20 €	2500	10,350
16 L/h	DRP43000004	0,20 €	2500	10,300

Siyah Hat Üstü Damlatıcı
Black On-Line Dripper



Çap Dia (mm)	Kod Code	Fiyat (Adet) Price (Pcs)	Koli Adet Box Pcs	Kg/Koli Kg/Box
0-150 L/h	DRP44000001	0,11 €	2000	10,350

Yeşil Hat Üstü Damlatıcı
Green On-Line Dripper



Çap Dia (mm)	Kod Code	Fiyat (Adet) Price (Pcs)	Koli Adet Box Pcs	Kg/Koli Kg/Box
0-100 L/h	DRP45000001	0,08 €	2000	8,100

Kırmızı Hat Üstü Damlatıcı
Red On-Line Dripper



Çap Dia (mm)	Kod Code	Fiyat (Adet) Price (Pcs)	Koli Adet Box Pcs	Kg/Koli Kg/Box
0-70 L/h	DRP46000001	0,07 €	5000	10,350

Spagetti Boru (Beyaz/Siyah Kaplama)
Microtube Pipe (Spaghetti)



Çap Dia (mm)	Kod Code	Fiyat (Adet) Price (Pcs)	Koli Adet Box Pcs	Kg/Koli Kg/Box
5	DRP47000001	①	250 mt	3,000
7	DRP47000002	①	250 mt	4,000
5	DRP47000003	①	60 cm	7,200
7	DRP47000004	①	60 cm	9,600
5	DRP47000005	①	100 cm	12,00
7	DRP47000006	①	100 cm	16,00

Mini Sprey 120 L/h
Radius Stable Mini Sprayer



Çap Dia (mm)	Kod Code	Fiyat (Adet) Price (Pcs)	Koli Adet Box Pcs	Kg/Koli Kg/Box
180°	DRP48000001	0,11 €	12000	19,180
360°	DRP48000002	0,11 €	15000	18,570

Basınç Ayarlı Saksı Sulama Seti
PC Emitters Stake Set



Çap Dia (mm)	Kod Code	Fiyat (Adet) Price (Pcs)	Koli Adet Box Pcs	Kg/Koli Kg/Box
2 L/h	DRP49000001	①	500	7,150
4 L/h	DRP49000002	①	500	7,150
8 L/h	DRP49000003	①	500	7,150
16 L/h	DRP49000004	①	500	7,150

PC Damlatıcı İstavroz Konnektörü
Emitter Four Way Manifold



Çap Dia (mm)	Kod Code	Fiyat (Adet) Price (Pcs)	Koli Adet Box Pcs	Kg/Koli Kg/Box
5 mm	DRP50000001	0,11 €	15000	12,300

PC Damlatıcı TE Konnektörü
Emitter Tee Manifold



Çap Dia (mm)	Kod Code	Fiyat (Adet) Price (Pcs)	Koli Adet Box Pcs	Kg/Koli Kg/Box
5 mm	DRP51000001	0,11 €	24000	15,150

PC Damlatıcı Dirsek Konnektörü
Emitter Elbow Manifold



Çap Dia (mm)	Kod Code	Fiyat (Adet) Price (Pcs)	Koli Adet Box Pcs	Kg/Koli Kg/Box
5 mm	DRP52000001	0,10 €	30000	15,750

PC Damlatıcı Çıkış Konnektörü
Emitter Outlet Connector



Çap Dia (mm)	Kod Code	Fiyat (Adet) Price (Pcs)	Koli Adet Box Pcs	Kg/Koli Kg/Box
5 mm	DRP53000001	0,06 €	45000	14,150

Körtapa
Plug For Microtube



Çap Dia (mm)	Kod Code	Fiyat (Adet) Price (Pcs)	Koli Adet Box Pcs	Kg/Koli Kg/Box
7 mm	DRP54000001	0,06 €	45000	13,450

Hortum Eki
Coupling For Microtube



Çap Dia (mm)	Kod Code	Fiyat (Adet) Price (Pcs)	Koli Adet Box Pcs	Kg/Koli Kg/Box
5 mm	DRP55000001	0,06 €	48000	14,950
7 mm	DRP55000002	0,07 €	18000	13,550

Saksı Sulama Kazığı
Hydroponic Stake



Çap Dia (mm)	Kod Code	Fiyat (Adet) Price (Pcs)	Koli Adet Box Pcs	Kg/Koli Kg/Box
5 mm	DRP56000001	0,08 €	-	-
5 mm (2.3 L/h)	DRP56000002	0,14 €	-	-

Start Çıkışı
Starter Outlet Microtube



Çap Dia (mm)	Kod Code	Fiyat (Adet) Price (Pcs)	Koli Adet Box Pcs	Kg/Koli Kg/Box
5 mm	DRP57000001	0,06 €	-	-

PBT Yeni Nesil Vana
 PBT New Generation Valve

Çap Dia (mm)	Kod Code	Fiyat (Adet) Price (Pcs)	Koli Adet Box Pcs	Kg/Koli Kg/Box
1/2"	DRP58000001	①	250	-
3/4"	DRP58000002	2,76 €	125	12,500
1"	DRP58000003	3,54 €	65	10,750
1 1/4"	DRP58000004	5,40 €	40	9,460
1 1/2"	DRP58000005	6,60 €	35	10,760
2"	DRP58000006	8,16 €	18	10,000
2 1/2"	DRP58000007	18,00 €	12	11,150
3"	DRP58000008	30,00 €	7	10,100
4"	DRP58000009	56,16 €	4	12,550

PBT Yeni Nesil Metal Dişli Vana
 PBT New Generation Valve With Metal Female Threaded

Çap Dia (mm)	Kod Code	Fiyat (Adet) Price (Pcs)	Koli Adet Box Pcs	Kg/Koli Kg/Box
1 1/2"	DRP59000001	①	-	-
2"	DRP59000002	①	-	-
2 1/2"	DRP59000003	①	-	-
3"	DRP59000004	①	-	-
4"	DRP59000005	①	-	-

3/4" Yeni Nesil Sprey Sprink
 3/4" Garden & Land Sprey

Çap Dia (mm)	Kod Code	Fiyat (Adet) Price (Pcs)	Koli Adet Box Pcs	Kg/Koli Kg/Box
3/4"	DRP77000001	0,96 €	400	8,500

Sprink Manşonu
 Reduction

Çap Dia (mm)	Kod Code	Fiyat (Adet) Price (Pcs)	Koli Adet Box Pcs	Kg/Koli Kg/Box
32x20	DRP78000001	0,38 €	350	-
32x25	DRP78000002	0,42 €	350	-
32x32	DRP78000003	①	-	-

Plastik Mini Filtre (Krom Elek)
 Plastic Mini Filter (Sieve)

Çap Dia (mm)	Kod Code	Fiyat (Adet) Price (Pcs)	Koli Adet Box Pcs	Kg/Koli Kg/Box
20"	DRP60000001	9,00 €	20	8,920
25"	DRP60000002	9,00 €	20	7,100
32"	DRP60000003	9,00 €	20	7,050
40"	DRP60000004	15,90 €	7	6,150
50"	DRP60000005	15,90 €	7	6,160
63"	DRP60000006	15,90 €	7	6,550

Plastik Filtre (Krom Elek)
 Plastic Filter (Sieve)

Çap Dia (mm)	Kod Code	Fiyat (Adet) Price (Pcs)	Koli Adet Box Pcs	Kg/Koli Kg/Box
2 1/2"	DRP61000001	①	1	-
3"	DRP61000002	①	1	-
4"	DRP61000003	①	1	-

Plastik Filtre (Disk)
 Plastic Filter (Disc)

Çap Dia (mm)	Kod Code	Fiyat (Adet) Price (Pcs)	Koli Adet Box Pcs	Kg/Koli Kg/Box
2 1/2"	DRP62000001	330,00 €	1	8,600
3"	DRP62000002	330,00 €	1	-
4"	DRP62000003	330,00 €	1	-

Double Filtre
 Double Plastic Filter

Çap Dia (mm)	Kod Code	Fiyat (Adet) Price (Pcs)	Koli Adet Box Pcs	Kg/Koli Kg/Box
2 1/2" Krom Elek	DRP63000001	①	1	15,180
3" Krom Elek	DRP63000002	①	1	-
4" Krom Elek	DRP63000003	①	1	-
2 1/2" Disk	DRP63000004	①	1	-
3" Disk	DRP63000005	①	1	-
4" Disk	DRP63000006	①	1	-

Filtre İç Takımı
 Mini Filter Interior Set

Çap Dia (mm)	Kod Code	Fiyat (Adet) Price (Pcs)	Koli Adet Box Pcs	Kg/Koli Kg/Box
Small	DRP64000001	5,40 €	25	7,300
Big	DRP64000002	8,10 €	25	4,880

Abot Üstü Dağıtıcı
Pipe Distributor

Çap Dia (mm)	Kod Code	Fiyat (Adet) Price (Pcs)	Koli Adet Box Pcs	Kg/Koli Kg/Box
32x32x20	DRP65000001	0,86 €	100	5,760
32x32x25	DRP65000002	0,76 €	100	5,710

Çap Dia (mm)	Kod Code	Fiyat (Adet) Price (Pcs)	Koli Adet Box Pcs	Kg/Koli Kg/Box
32x25x20	DRP66000001	0,82 €	150	5,570

Çap Dia (mm)	Kod Code	Fiyat (Adet) Price (Pcs)	Koli Adet Box Pcs	Kg/Koli Kg/Box
32x20	DRP67000001	0,91 €	150	9,350

Kazık Saplama
Stake Fixing

Çap Dia (mm)	Kod Code	Fiyat (Adet) Price (Pcs)	Koli Adet Box Pcs	Kg/Koli Kg/Box
1/2x20	DRP68000001	0,37 €	400	7,820
1/2x25	DRP68000002	0,41 €	300	7,360

Çap Dia (mm)	Kod Code	Fiyat (Adet) Price (Pcs)	Koli Adet Box Pcs	Kg/Koli Kg/Box
1/2x1/2	DRP69000001	0,36 €	500	7,970

PP

ÜRÜN GRUBU
PRODUCT LINEÜRETİM STANDARTI
PRODUCTION STANDARD | TS ISO 9911

ÇAP / SIZE Ø20 - Ø400



Not / Note

PPRC

ÜRÜN GRUBU

PRODUCT LINE

ÜRETİM STANDARDI

PRODUCTION STANDARD

TS EN ISO 15874-3

ÇAP / SIZE Ø20 - Ø125

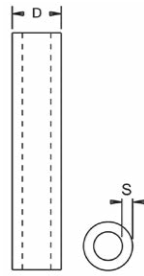

PP-R Boru
 PP-R Pipe

PN 10

Çap Dia	Basınç Pn	Kod Code	Fiyat (Adet) Price (Pcs)	Min. Sipariş Adet Min. Order Quant.	L (m)	S	D
20	10	800 00 020 2	1,43 €	140	4	1.9	20.3
25	10	800 00 025 2	2,07 €	100	4	2.3	25.3
32	10	800 00 032 2	3,54 €	60	4	2.9	32.3
40	10	800 00 040 2	6,03 €	40	4	3.7	40.4
50	10	800 00 050 2	8,84 €	24	4	4.6	50.5
63	10	800 00 063 2	14,87 €	20	4	5.8	63.6
75	10	800 00 075 2	18,96 €	12	4	6.8	75.7
90	10	800 00 090 2	32,78 €	8	4	8.2	90.9
110	10	800 00 110 2	45,52 €	4	4	10	111
125	10	800 00 125 2	76,90 €	4	4	11.4	126.2

PN 16

Çap Dia	Basınç Pn	Kod Code	Fiyat (Adet) Price (Pcs)	Min. Sipariş Adet Min. Order Quant.	L (m)	S	D
20	16	800 01 020 2	1,59 €	140	4	2.8	20.3
25	16	800 01 025 2	2,46 €	100	4	3.5	25.3
32	16	800 01 032 2	4,59 €	60	4	4.4	32.3
40	16	800 01 040 2	7,12 €	40	4	5.5	40.4
50	16	800 01 050 2	11,35 €	24	4	6.9	50.5
63	16	800 01 063 2	17,95 €	20	4	8.6	63.6
75	16	800 01 075 2	25,65 €	12	4	10.3	75.7
90	16	800 01 090 2	41,02 €	8	4	12.3	90.9
110	16	800 01 110 2	61,21 €	4	4	15.1	111
125	16	800 01 125 2	82,82 €	4	4	17.1	126.2

PN 20

Çap Dia	Basınç Pn	Kod Code	Fiyat (Adet) Price (Pcs)	Min. Sipariş Adet Min. Order Quant.	L (m)	S	D
20	20	800 02 020 2	1,87 €	140	4	3.4	20.3
25	20	800 02 025 2	3,08 €	100	4	4.2	25.3
32	20	800 02 032 2	5,93 €	60	4	5.4	32.3
40	20	800 02 040 2	8,37 €	40	4	6.7	40.4
50	20	800 02 050 2	13,36 €	24	4	8.3	50.5
63	20	800 02 063 2	21,43 €	20	4	10.5	63.6
75	20	800 02 075 2	32,37 €	12	4	12.5	75.7
90	20	800 02 090 2	52,14 €	8	4	15.0	90.9
110	20	800 02 110 2	77,62 €	4	4	18.3	111
125	20	800 02 125 2	99,26 €	4	4	20.8	126.2

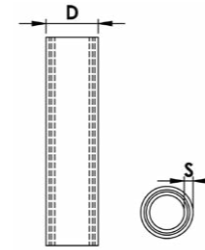
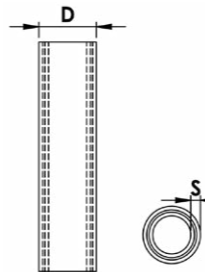
PP-R Foroxi Boru
 PP-R Foroxi Pipe

PP-R Kompozit Boru
 PP-R Composite Pipe

PN 25

Çap Dia	Basınç Pn	Kod Code	Fiyat (Adet) Price (Pcs)	Koli/Adet Box/Pcs	S	D
20	25	800 03 020 2	3,50 €	140/4.00	3.4	20.3
25	25	800 03 025 2	4,98 €	100/4.00	4.2	25.3
32	25	800 03 032 2	8,30 €	60/4.00	5.4	32.3
40	25	800 03 040 2	11,59 €	40/4.00	6.7	40.4
50	25	800 03 050 2	17,51 €	24/4.00	8.3	50.5
63	25	800 03 063 2	27,09 €	20/4.00	10.5	63.6
75	25	800 03 075 2	46,42 €	12/4.00	12.5	75.7
90	25	800 03 090 2	66,85 €	8/4.00	15.0	90.9

PN 20

Çap Dia	Basınç Pn	Kod Code	Fiyat (Adet) Price (Pcs)	Koli/Adet Box/Pcs	S	D
20	20	800 04 020 2	2,00 €	140/4.00	2.8	20.3
25	20	800 04 025 2	3,07 €	100/4.00	3.5	25.3
32	20	800 04 032 2	4,90 €	60/4.00	4.4	32.3
40	20	800 04 040 2	7,62 €	40/4.00	5.5	40.4
50	20	800 04 050 2	12,46 €	24/4.00	6.9	50.5
63	20	800 04 063 2	19,41 €	20/4.00	8.6	63.6
75	20	800 04 075 2	27,83 €	12/4.00	10.3	75.7
90	20	800 04 090 2	41,62 €	8/4.00	12.3	90.9
110	20	800 04 110 2	63,55 €	44.00	15.1	111
125	20	800 04 125 2	85,23 €	4/4.00	17.1	126.2

PN 25

Çap Dia	Basınç Pn	Kod Code	Fiyat (Adet) Price (Pcs)	Koli/Adet Box/Pcs	S	D
20	25	800 05 020 2	2,38 €	140/4.00	3.4	20.3
25	25	800 05 025 2	3,50 €	100/4.00	4.2	25.3
32	25	800 05 032 2	6,20 €	60/4.00	5.4	32.3
40	25	800 05 040 2	9,64 €	40/4.00	6.7	40.4
50	25	800 05 050 2	15,28 €	24/4.00	8.3	50.5
63	25	800 05 063 2	23,95 €	20/4.00	10.5	63.6
75	25	800 05 075 2	33,99 €	12/4.00	12.5	75.7
90	25	800 05 090 2	48,97 €	8/4.00	15.0	90.9
110	25	800 05 110 2	74,49 €	44.00	18.3	111
125	25	800 05 125 2	100,19 €	4/4.00	20.8	126.2

PP-R Omega
PP-R Omega

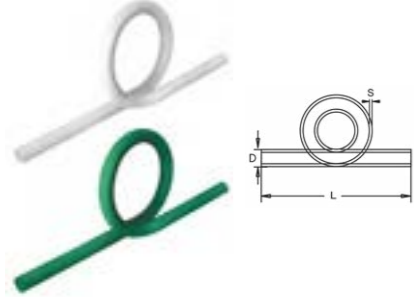

Çap Dia	Basınç Pn	Kod Code	Fiyat (Adet) Price (Pcs)	Koli/Adet Box/Pcs	S	D	L
20	16	802 00 020	3,62 €	85	3.4	20.3	350
25	16	802 00 025	5,80 €	45	4.2	25.3	350
32	16	802 00 032	8,70 €	22	5.4	32.3	350
40	16	802 00 040	14,02 €	15	6.7	40.4	350

PP-R Kavis
PP-R Crossover



Çap Dia	Basınç Pn	Kod Code	Fiyat (Adet) Price (Pcs)	Koli/Adet Box/Pcs	S	D	L
20	16	801 07 020	0,90 €	160	3.4	20.3	350
25	16	801 07 025	1,49 €	100	4.2	25.3	350
32	16	801 07 032	3,11 €	65	5.4	32.3	350
40	16	801 07 040	4,88 €	40	6.7	40.4	350

PP-R Kavis Manşonlu - Uzun
PP-R Crossover With Socket - Long

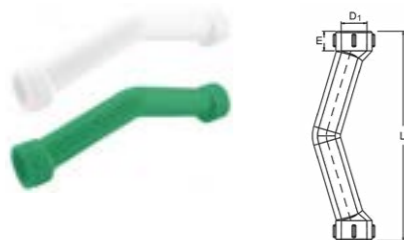

Çap Dia	Basınç Pn	Kod Code	Fiyat (Adet) Price (Pcs)	Koli/Adet Box/Pcs	D1	E	L
20	16	801 08 020	1,00 €	160	19.5	20.3	350
25	16	801 08 025	1,59 €	100	24.5	25.3	350
32	16	801 08 032	4,44 €	65	31.5	32.3	350

PP-R Kavis Manşonlu - Kısa (C Tip)
PP-R Crossover with Socket - Short



Çap Dia	Basınç Pn	Kod Code	Fiyat (Adet) Price (Pcs)	Koli/Adet Box/Pcs	d1	E	L
20	16	801 09 020	0,74 €	200	19.5	14.5	86
25	16	801 09 025	1,22 €	125	24.5	16	95
32	16	801 09 032	2,59 €	60	31.5	18	117

PP-R Kavisli Dirsek
PP-R Bend



Çap Dia	Basınç Pn	Kod Code	Fiyat (Adet) Price (Pcs)	Koli/Adet Box/Pcs	d1	E	L
25	16	800 09 025 2	1,32 €	125	24.5	16	66
32	16	800 09 032 2	2,77 €	60	31.5	18	83

PP-R Uzun Te
PP-R Long Tee



Çap Dia	Basınç Pn	Kod Code	Fiyat (Adet) Price (Pcs)	Koli/Adet Box/Pcs	S	D	L1	L2
20	16	801 10 020	0,94 €	100	19.5	14.5	49	146
25	16	801 10 025	1,13 €	70	24.5	16	59	163

PP-R Manşon
PP-R Socket

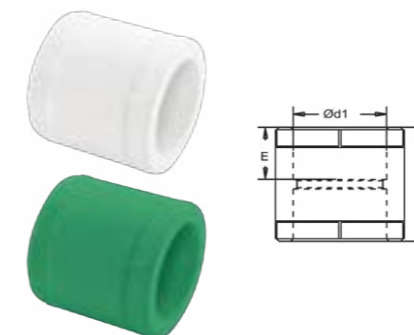

Çap Dia	Basınç Pn	Kod Code	Fiyat (Adet) Price (Pcs)	Koli/Adet Box/Pcs	d1	E	L
20	16	800 05 020 2	0,17 €	600	19.5	14.5	34
25	16	800 05 025 2	0,29 €	300	24.5	16	37
32	16	800 05 032 2	0,56 €	200	31.5	18	41
40	16	800 05 040 2	0,94 €	100	39.4	20.5	45
50	16	800 05 050 2	1,49 €	60	49.4	23.5	52
63	16	800 05 063 2	2,82 €	36	62.5	27.5	60
75	16	800 05 075 2	5,13 €	24	74.2	31	65
90	16	800 05 090 2	8,28 €	16	89.2	35.5	71
110	16	800 05 110 2	13,96 €	6	109	41.5	79
125	16	800 05 125 2	26,18 €	4	123.9	46.5	104

PP-R Redüksiyon Manşon
PP-R Reducer Socket

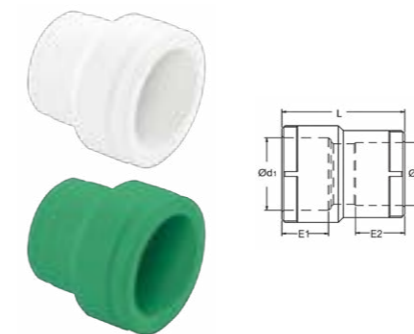

Çap Dia	Basınç Pn	Kod Code	Fiyat (Adet) Price (Pcs)	Koli/Adet Box/Pcs	d1	d2	E1	E2	L
25/20	16	810 00 2520 2	0,31 €	400	24.5	19.5	16	14.5	35
32/20	16	810 00 3220 2	0,49 €	300	31.5	19.5	18	14.5	38
32/25	16	810 00 3225 2	0,59 €	250	31.5	24.5	18	16	40
40/20	16	810 00 4020 2	1,14 €	150	39.4	19.5	20.5	14.5	47
40/25	16	810 00 4025 2	1,21 €	150	39.4	24.5	20.5	16	47
40/32	16	810 00 4032 2	1,35 €	125	39.4	31.5	20.5	18	47
50/20	16	810 00 5020 2	1,68 €	100	49.4	19.5	23.5	14.5	50
50/25	16	810 00 5025 2	1,75 €	100	49.4	24.5	23.5	16	50
50/32	16	810 00 5032 2	1,88 €	80	49.4	31.5	23.5	18	50
50/40	16	810 00 5040 2	2,02 €	75	49.4	39.4	23.5	20.5	50
63/20	16	810 00 6320 2	3,16 €	40	62.5	19.5	27.5	14.5	60
63/25	16	810 00 6325 2	3,23 €	40	62.5	24.5	27.5	16	60
63/32	16	810 00 6332 2	3,50 €	40	62.5	31.5	27.5	18	60
63/40	16	810 00 6340 2	3,63 €	40	62.5	39.4	27.5	20.5	65
63/50	16	810 00 6350 2	3,70 €	35	62.5	49.4	27.5	23.5	66

PP-R Redüksiyon
PP-R Reducer

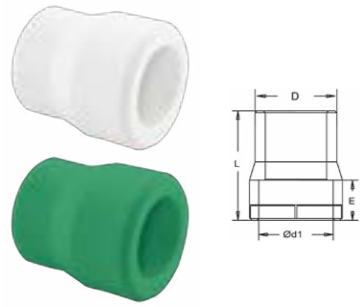

Çap Dia	Basınç Pn	Kod Code	Fiyat (Adet) Price (Pcs)	Koli/Adet Box/Pcs	d1	E	D	L
25/20	16	801 03 2520 2	0,23 €	500	19.5	14.5	25	39
32/20	16	801 03 3220 2	0,29 €	400	19.5	14.5	32	39
32/25	16	801 03 3225 2	0,35 €	300	24.5	16	32	43
40/20	16	801 03 4020 2	0,59 €	200	19.5	14.5	40	39
40/25	16	801 03 4025 2	0,61 €	200	24.5	16	40	43
40/32	16	801 03 4032 2	0,68 €	150	31.5	18	40	48
50/25	16	801 03 5025 2	0,97 €	100	24.5	16	50	43
50/32	16	801 03 5032 2	1,05 €	100	31.5	18	50	48
50/40	16	801 03 5040 2	1,20 €	80	39.4	20.5	50	52
63/32	16	801 03 6332 2	2,37 €	60	31.5	18	63	48
63/40	16	801 03 6340 2	2,40 €	60	39.4	20.5	63	52
63/50	16	801 03 6350 2	2,67 €	50	49.4	23.5	63	60
75/40	16	801 03 7540 2	3,34 €	40	39.4	20.5	75	52
75/50	16	801 03 7550 2	3,34 €	40	49.4	23.5	75	60
75/63	16	801 03 7563 2	4,03 €	30	62.5	27.5	75	67
90/50	16	801 03 9050 2	6,22 €	20	49.4	23.5	90	60
90/63	16	801 03 9063 2	6,22 €	20	62.5	27.5	90	67
90/75	16	801 03 9075 2	6,76 €	16	74.2	31	90	72
110/63	16	801 03 11063 2	8,89 €	16	62.5	27.5	110	67
110/75	16	801 03 11075 2	8,89 €	16	74.2	31	110	72
110/90	16	801 03 11090 2	10,92 €	16	89.2	35.5	110	90
125/90	16	801 03 12590 2	23,93 €	6	89.2	35.5	125	120
125/110	16	801 03 125110 2	23,93 €	5	109	41.5	125	120

PP-R 90° Dirsek
PP-R 90° Elbow

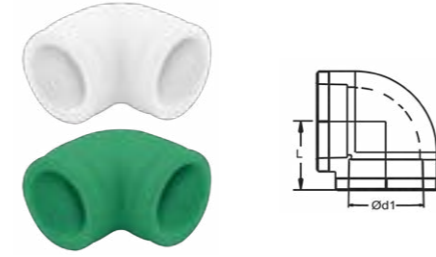

Çap Dia	Basınç Pn	Kod Code	Fiyat (Adet) Price (Pcs)	Koli/Adet Box/Pcs	d1	E	L
20	16	800 07 020 2	0,25 €	400	19.5	14.5	23
25	16	800 07 025 2	0,39 €	250	24.5	16	25
32	16	800 07 032 2	0,74 €	125	31.5	18	28
40	16	800 07 040 2	1,53 €	60	39.4	20.5	32
50	16	800 07 050 2	2,73 €	35	49.4	23.5	37
63	16	800 07 063 2	5,27 €	15	62.5	27.5	54
75	16	800 07 075 2	7,49 €	12	74.2	31	60
90	16	800 07 090 2	13,72 €	6	89.2	35.5	76
110	16	800 07 110 2	23,40 €	2	109	41.5	94
125	16	800 07 125 2	47,28 €	2	123.9	46.5	110

PP-R 45° Dirsek
PP-R 45° Elbow

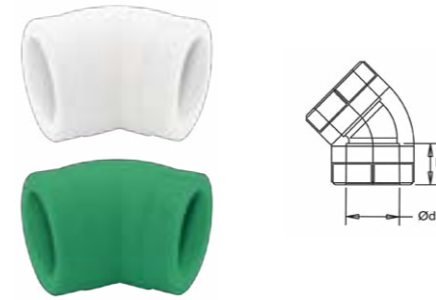

Çap Dia	Basınç Pn	Kod Code	Fiyat (Adet) Price (Pcs)	Koli/Adet Box/Pcs	d1	E
20	16	800 06 020 2	0,35 €	500	19.5	14.5
25	16	800 06 025 2	0,50 €	300	24.5	16
32	16	800 06 032 2	0,83 €	125	31.5	18
40	16	800 06 040 2	1,45 €	80	39.4	20.5
50	16	800 06 050 2	2,89 €	40	49.4	23.5
63	16	800 06 063 2	5,17 €	20	62.5	27.5
75	16	800 06 075 2	11,00 €	15	74.2	31
90	16	800 06 090 2	20,90 €	8	89.2	35.5
110	16	800 06 110 2	35,00 €	4	109	41.5

PP-R 90° Redüksiyon Dirsek
PP-R 90° Reducer Elbow

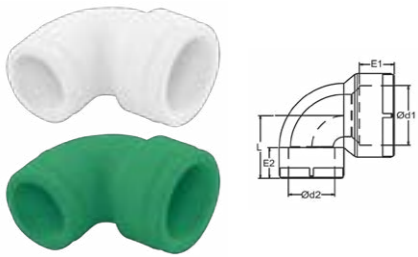

Çap Dia	Basınç Pn	Kod Code	Fiyat (Adet) Price (Pcs)	Koli/Adet Box/Pcs	d1	d2	E1	E2	L
25/20	16	800 09 2520 2	0,49 €	200	24.5	19.5	16	14.5	29
32/25	16	800 09 3225 2	0,86 €	150	31.5	24.5	18	16	33

PP-R 45° Kuyruklu Dirsek
PP-R 45° Tail Elbow

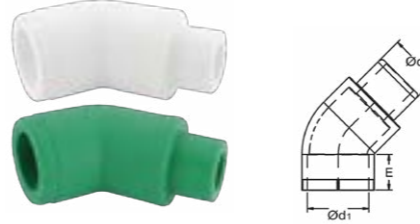

Çap Dia	Basınç Pn	Kod Code	Fiyat (Adet) Price (Pcs)	Koli/Adet Box/Pcs	d1	d2	E
20	16	800 08 020 2	0,36 €	300	19.5	20.3	14.5
25	16	800 08 025 2	0,53 €	200	24.5	25.3	16
32	16	800 08 032 2	1,00 €	100	31.5	32.3	18

PP-R 90° Kuyruklu Dirsek
PP-R 90° Tail Elbow

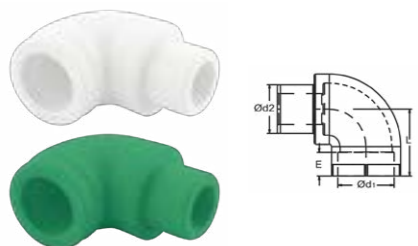

Çap Dia	Basınç Pn	Kod Code	Fiyat (Adet) Price (Pcs)	Koli/Adet Box/Pcs	d1	d2	E	L
20	16	800 18 020 2	0,47 €	300	19.5	20.3	14.5	23
25	16	800 18 025 2	0,77 €	200	24.5	25.3	16	25
32	16	800 18 032 2	1,19 €	100	31.5	32.3	18	28

PP-R Te
PP-R Tee

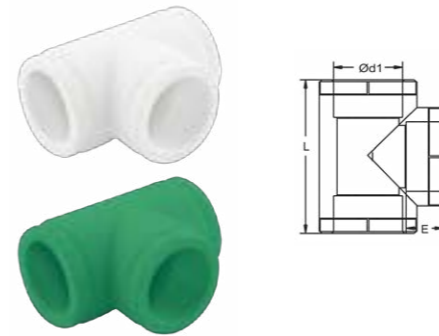

Çap Dia	Basınç Pn	Kod Code	Fiyat (Adet) Price (Pcs)	Koli/Adet Box/Pcs	d1	E	L
20	16	801 00 020 2	0,38 €	250	19.5	14.5	52
25	16	801 00 025 2	0,54 €	150	24.5	16	59
32	16	801 00 032 2	1,08 €	80	31.5	18	70
40	16	801 00 040 2	1,81 €	40	39.4	20.5	82
50	16	801 00 050 2	3,58 €	25	49.4	23.5	100
63	16	801 00 063 2	6,90 €	16	62.5	27.5	120
75	16	801 00 075 2	11,05 €	10	74.2	31	137
90	16	801 00 090 2	18,67 €	5	89.2	35.5	160
110	16	801 00 110 2	31,26 €	2	109	41.5	190
125	16	801 00 125 2	68,91 €	2	123.9	46.5	221

PP-R Kapama Başlığı
PP-R Stopend

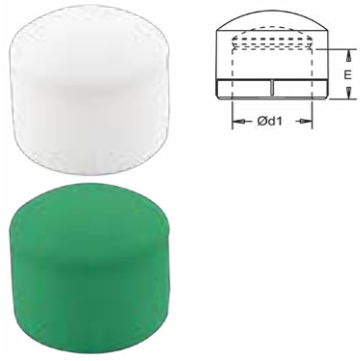

Çap Dia	Basınç Pn	Kod Code	Fiyat (Adet) Price (Pcs)	Koli/Adet Box/Pcs	d1	E
20	16	802 20 020 2	0,22 €	750	19.5	14.5
25	16	802 20 025 2	0,29 €	500	24.5	16
32	16	802 20 032 2	0,50 €	250	31.5	18
40	16	802 20 040 2	0,70 €	150	39.5	20.5
50	16	802 20 050 2	1,26 €	80	49.4	23.5
63	16	802 20 063 2	2,47 €	50	62.5	27.5
75	16	802 20 075 2	4,87 €	25	74.2	31
90	16	802 20 090 2	6,38 €	18	89.2	35.5
110	16	802 20 110 2	13,80 €	9	109	41.5
125	16	802 20 125 2	23,57 €	6	123.9	46.5

PP-R Flanş Adaptörü
PP-R Flange Adaptor

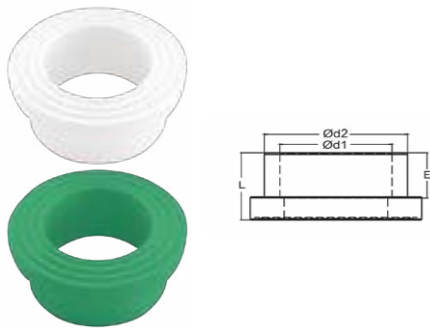

Çap Dia	Basınç Pn	Kod Code	Fiyat (Adet) Price (Pcs)	Koli/Adet Box/Pcs	d1	d2	E	L
50	16	810 04 050 2	3,58 €	80	49.4	65	23.5	32
63	16	810 04 063 2	4,47 €	50	62.5	80	27.5	40
75	16	810 04 075 2	8,35 €	40	74.2	95	31	40
90	16	810 04 090 2	10,42 €	25	89.2	111	35.5	42
110	16	810 04 110 2	13,73 €	12	109	132	41.5	49

PP-R Flanş
PP-R Flange

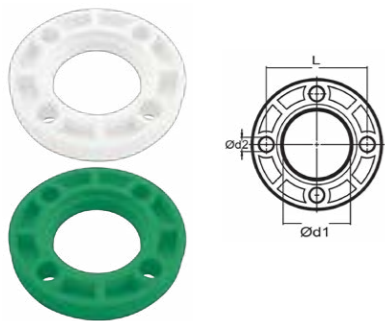

Çap Dia	Basınç Pn	Kod Code	Fiyat (Adet) Price (Pcs)	Koli/Adet Box/Pcs	d1	d2	E	L
50	16	810 05 050 2	10,73 €	80	66	17	109	30
63	16	810 05 063 2	11,93 €	50	81	17	121	30
75	16	810 05 075 2	20,89 €	40	97	17	144	16
90	16	810 05 090 2	23,85 €	25	113	17	160	16
110	16	810 05 110 2	29,81 €	12	133	17	180	12

PP-R Uzun Körtapa
PP-R End Plug-Long



Çap Dia	Basınç Pn	Kod Code	Fiyat (Adet) Price (Pcs)	Koli/Adet Box/Pcs	d	L	E
20x1/2"	16	810 06 020 2	0,36 €	750	20.3	56	5

PP-R Körtapa
PP-R End Plug



Çap Dia	Basınç Pn	Kod Code	Fiyat (Adet) Price (Pcs)	Koli/Adet Box/Pcs	D	L
20x1/2"	16	810 07 020 2	0,22 €	2500	20.3	25
25x3/4"	16	810 07 025 2	0,17 €	2500	26	15

Cetvel Ruler

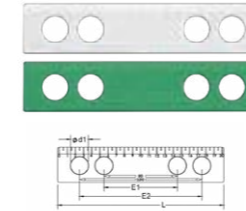

Çap Dia	Basınç Pn	Kod Code	Fiyat (Adet) Price (Pcs)	Koli/Adet Box/Pcs	d1	E1	E2	L
1/2"	16	810 08 020 2	1,03 €	400	20.5	90	150	200

PP-R Erkek İstavroz
PP-R Male Cross

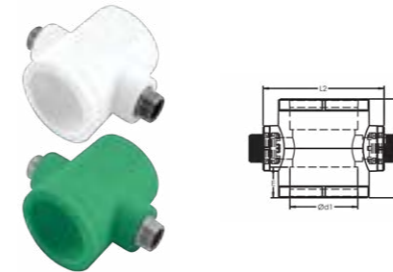

Çap Dia	Basınç Pn	Kod Code	Fiyat (Adet) Price (Pcs)	Koli/Adet Box/Pcs	d1	E	L1	L2
50x1/2"	16	810 09 5020 2	18,51 €	16	49.4	23.5	84	95
50x3/4"	16	810 09 5025 2	22,70 €	16	49.4	23.5	84	95
50x1"	16	810 09 5032 2	27,93 €	16	49.4	23.5	114	95
50x1 1/4"	16	810 09 5040 2	31,43 €	12	49.4	23.5	114	95
63x1/2"	16	810 09 6320 2	27,93 €	8	62.5	27.5	91	111
63x3/4"	16	810 09 6325 2	31,43 €	8	62.5	27.5	91	111
63x1"	16	810 09 6332 2	34,90 €	8	62.5	27.5	127	113
63x1 1/4"	16	810 09 6340 2	38,48 €	6	62.5	27.5	127	120

PP-R Dişi İstavroz
PP-R Female Cross

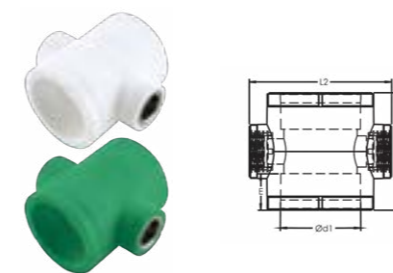

Çap Dia	Basınç Pn	Kod Code	Fiyat (Adet) Price (Pcs)	Koli/Adet Box/Pcs	d1	E	L1	L2
25x1/2"	16	811 00 2520 2	4,43 €	80	24.5	16	56	56
32x3/4"	16	811 00 3225 2	6,95 €	40	31.5	18	70	70
40x3/4"	16	811 00 4025 2	8,20 €	20	39.5	20.5	86	86
40x1"	16	811 00 4032 2	8,86 €	20	39.5	20.5	86	86
50x1/2"	16	811 00 5020 2	9,84 €	16	49.4	23.5	84	95
50x3/4"	16	811 00 5025 2	10,94 €	16	49.4	23.5	84	95
50x1"	16	811 00 5032 2	16,76 €	16	49.4	23.5	114	95
50x1 1/4"	16	811 00 5040 2	21,86 €	12	49.4	23.5	114	95
63x1/2"	16	811 00 6320 2	12,39 €	8	62.5	27.5	91	111
63x3/4"	16	811 00 6325 2	14,43 €	8	62.5	27.5	91	111
63x1"	16	811 00 6332 2	19,31 €	8	62.5	27.5	127	113
63x1 1/4"	16	811 00 6340 2	25,51 €	6	62.5	27.5	127	120

PP-R Plastik Branşman
PP-R Saddle

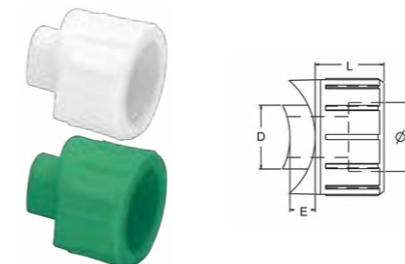

Çap Dia	Basınç Pn	Kod Code	Fiyat (Adet) Price (Pcs)	Koli/Adet Box/Pcs	d1	E	D	L
20	16	811 01 020 2	1,57 €	300	19.5	14.5	20.3	22
25	16	811 01 025 2	2,13 €	200	24.5	16	25.3	25
32	16	811 01 032 2	4,50 €	100	31.5	18	32.3	30

PP-R Erkek Branşman

PP-R Saddle Male

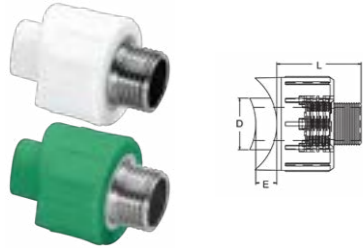

Çap Dia	Basınç Pn	Kod Code	Fiyat (Adet) Price (Pcs)	Koli/Adet Box/Pcs	D	E	L
20x1/2"	16	811 02 020 2	3,67 €	150	20.3	14.5	40
25x3/4"	16	811 02 025 2	5,74 €	100	25.3	16	42
32x1"	16	811 02 032 2	10,33 €	50	32.3	18	44

PP-R Dişi Branşman

PP-R Saddle Female

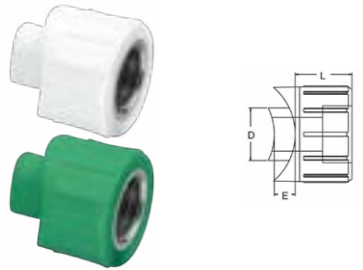

Çap Dia	Basınç Pn	Kod Code	Fiyat (Adet) Price (Pcs)	Koli/Adet Box/Pcs	D	E	L
20x1/2"	16	811 03 020 2	2,94 €	150	20.3	14.5	22
25x3/4"	16	811 03 025 2	3,98 €	100	25.3	16	25
32x1"	16	811 03 032 2	8,40 €	50	32.3	18	30

PP-R Erkek Nipel

PP-R Male Nipple

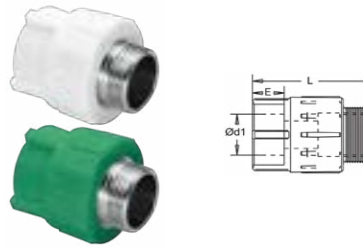

Çap Dia	Basınç Pn	Kod Code	Fiyat (Adet) Price (Pcs)	Koli/Adet Box/Pcs	d1	L	E
20x1/2"	16	811 04 2020 2	2,31 €	150	19.5	55	14.5
20x3/4"	16	811 04 2025 2	3,62 €	100	19.5	55	14.5
25x1/2"	16	811 04 2520 2	2,69 €	125	24.5	57	16
25x3/4"	16	811 04 2525 2	3,50 €	80	24.5	57	16
25x1"	16	811 04 2532 2	7,97 €	50	24.5	57	16
32x1/2"	16	811 04 3220 2	5,90 €	50	31.5	60	18
32x3/4"	16	811 04 3225 2	5,68 €	60	31.5	60	18
32x1"	16	811 04 3232 2	7,38 €	60	31.5	60	18

PP-R Altıköşe Erkek Nipel

PP-R Male Nipple Hexagonal

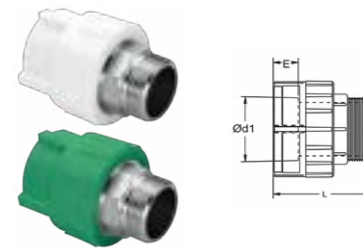

Çap Dia	Basınç Pn	Kod Code	Fiyat (Adet) Price (Pcs)	Koli/Adet Box/Pcs	d1	L	E
32 x 1"	16	811 05 3232 2	8,20 €	50	31.5	59	18
40 x 1"	16	811 05 4032 2	12,72 €	20	39.4	75	20.5
40 x 1 1/4"	16	811 05 4040 2	13,72 €	20	39.4	80	20.5
50 x 1 1/2"	16	811 05 5050 2	18,19 €	15	49.4	90	23.5
63 x 2"	16	811 05 6363 2	29,41 €	10	62.5	95	27.5
75 x 2 1/2"	16	811 05 7575 2	52,07 €	6	74.2	105	31
90 x 3"	16	811 05 9090 2	74,48 €	4	89.2	120	35.5
110 x 4"	16	811 05 0110 2	132,92 €	2	109	130	41.5
125 x 5"	16	811 05 0125 2	224,49 €	2	123.9	140	46.5

PP-R Dişi Nipel

PP-R Female Nipple



Çap Dia	Basınç Pn	Kod Code	Fiyat (Adet) Price (Pcs)	Koli/Adet Box/Pcs	d1	L	E
20 x 1/2"	16	811 06 2020 2	1,84 €	150	19.5	40	14.5
20 x 3/4"	16	811 06 2025 2	2,51 €	125	19.5	40	14.5
25 x 1/2"	16	811 06 2520 2	2,01 €	125	24.5	42	16
25 x 3/4"	16	811 06 2525 2	2,59 €	100	24.5	42	16
25 x 1"	16	811 06 2532 2	6,48 €	50	24.5	42	16
32 x 1/2"	16	811 06 3220 2	4,37 €	75	31.5	44	18
32 x 3/4"	16	811 06 3225 2	4,37 €	50	31.5	44	18
32 x 1"	16	811 06 3232 2	6,00 €	75	31.5	44	18

PP-R Altıköşe Dişi Nipel

PP-R Female Nipple Hexagonal

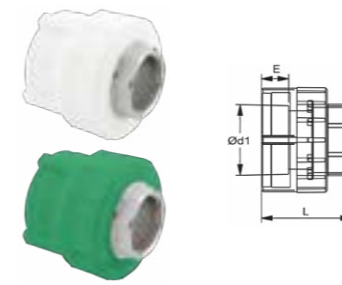

Çap Dia	Basınç Pn	Kod Code	Fiyat (Adet) Price (Pcs)	d1	L	E	Koli/Adet Box/Pcs
32 x 1"	16	811 07 3232 2	6,63 €	31.5	18	55	40
40 x 1"	16	811 07 4032 2	9,97 €	39.4	20.5	60	20
40 x 1 1/4"	16	811 07 4040 2	10,48 €	39.4	20.5	65	20
50 x 1 1/2"	16	811 07 5050 2	13,33 €	49.4	23.5	70	20
63 x 2"	16	811 07 6363 2	24,87 €	62.5	27.5	75	10
75 x 2 1/2"	16	811 07 7575 2	41,43 €	74.2	31	80	8
90 x 3"	16	811 07 9090 2	59,82 €	89.2	35.5	105	6
110 x 4"	16	811 07 0110 2	94,65 €	109	41.5	110	2
125 x 5"	16	811 07 0125 2	192,02 €	123.9	46.5	130	2

PP-R Erkek Dirsek

PP-R Male Elbow

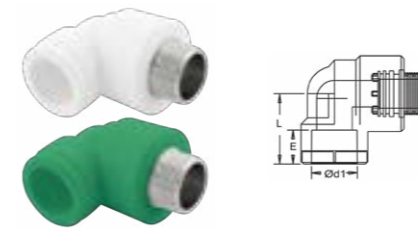

Çap Dia	Basınç Pn	Kod Code	Fiyat (Adet) Price (Pcs)	Koli/Adet Box/Pcs	d1	L	E
20 x 1/2"	16	811 08 2020 2	2,47 €	100	19.5	35	14.5
20 x 3/4"	16	811 08 2025 2	3,70 €	75	19.5	35	14.5
25 x 1/2"	16	811 08 2520 2	2,98 €	100	24.5	40	16
25 x 3/4"	16	811 08 2525 2	3,76 €	75	24.5	40	16
32 x 1/2"	16	811 08 3220 2	4,62 €	30	31.5	45	18
32 x 3/4"	16	811 08 3225 2	4,62 €	30	31.5	45	18
32 x 1"	16	811 08 3232 2	6,84 €	30	31.5	45	18

PP-R Altıköşe Erkek Dirsek

PP-R Male Elbow Hexagonal

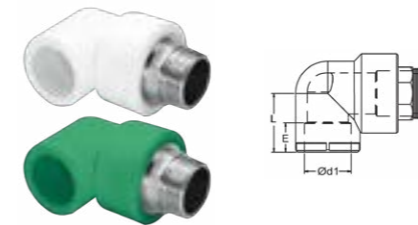

Çap Dia	Basınç Pn	Kod Code	Fiyat (Adet) Price (Pcs)	Koli/Adet Box/Pcs	d1	L	E
32 x 1"	16	811 09 3232 2	7,10 €	30	31.5	18	38.5
40 x 1 1/4"	16	811 09 4040 2	16,33 €	20	39.4	20.5	48.5
50 x 1 1/2"	16	811 09 5050 2	20,71 €	10	49.4	23.5	59
63 x 2"	16	811 09 6363 2	53,24 €	6	62.5	27.5	76.5

PP-R Dişi Dirsek

PP-R Female Elbow

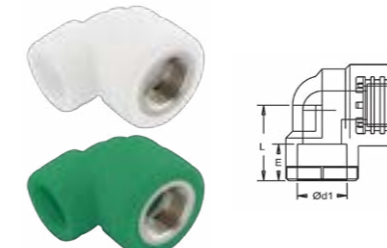

Çap Dia	Basınç Pn	Kod Code	Fiyat (Adet) Price (Pcs)	Koli/Adet Box/Pcs	d1	L	E
20 x 1/2"	16	812 00 2020 2	1,99 €	125	19.5	35	14.5
20 x 3/4"	16	812 00 2025 2	2,76 €	80	19.5	35	14.5
25 x 1/2"	16	812 00 2520 2	2,14 €	125	24.5	40	16
25 x 3/4"	16	812 00 2525 2	2,78 €	80	24.5	40	16
32 x 1/2"	16	812 00 3220 2	3,90 €	30	31.5	45	18
32 x 3/4"	16	812 00 3225 2	3,98 €	30	31.5	45	18
32 x 1"	16	812 00 3232 2	5,74 €	30	31.5	45	18

PP-R Altıköşe Dişi Dirsek

PP-R Female Elbow Hexagonal

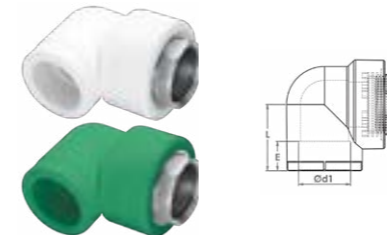

Çap Dia	Basınç Pn	Kod Code	Fiyat (Adet) Price (Pcs)	Koli/Adet Box/Pcs	d1	L	E
32 x 1"	16	812 01 3232 2	6,33 €	30	31.5	38.5	18
40 x 1 1/4"	16	812 01 4040 2	12,74 €	20	39.4	48.5	20.5
50 x 1 1/2"	16	812 01 5050 2	19,17 €	12	49.4	59	23.5
63 x 2"	16	812 01 6363 2	32,33 €	8	62.5	76.5	27.5

PP-R Erkek Batarya - 3 Ayak

PP-R Male Battery - Triple Connection



Çap Dia	Basınç Pn	Kod Code	Fiyat (Adet) Price (Pcs)	Koli/Adet Box/Pcs	d1	L	E
20 x 1/2"	16	812 02 2020 2	2,74 €	60	19.5	30	14.5
25 x 1/2"	16	812 02 2520 2	3,39 €	50	24.5	33	16

PP-R Dişi Batarya - 3 Ayak

PP-R Female Battery - Triple Connection



Çap Dia	Basınç Pn	Kod Code	Fiyat (Adet) Price (Pcs)	Koli/Adet Box/Pcs	d1	L	E
20 x 1/2"	16	812 03 2020 2	2,14 €	75	19.5	30	14.5
25 x 1/2"	16	812 03 2520 2	2,71 €	60	24.5	33	16

PP-R Dişi Batarya - 2 Ayak

PP-R Female Battery



Çap Dia	Basınç Pn	Kod Code	Fiyat (Adet) Price (Pcs)	Koli/Adet Box/Pcs	d1	L	E
25 x 3/4"	16	812 04 2525 2	3,70 €	60	24.5	40	16

PP-R Askılı Batarya

PP-R Female Battery Bypass



Çap Dia	Basınç Pn	Kod Code	Fiyat (Adet) Price (Pcs)	Koli/Adet Box/Pcs	d1	L	E
25 x 3/4"	16	812 05 2525 2	2,79 €	60	24.5	40	16

PP-R Erkek Çiftli Batarya Bağlantısı

PP-R Male Double Battery Connection

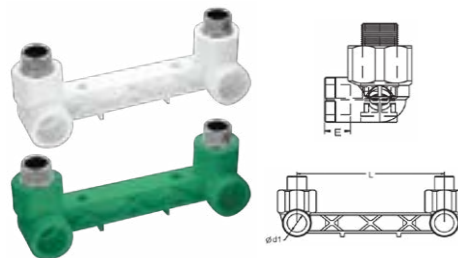

Çap Dia	Basınç Pn	Kod Code	Fiyat (Adet) Price (Pcs)	Koli/Adet Box/Pcs	d1	L	E
20 x 1/2"	16	812 06 2020 2	8,72 €	20	19.5	150	14.5
20 x 3/4"	16	812 06 2025 2	15,84 €	20	19.5	150	14.5
25 x 1/2"	16	812 06 2520 2	11,80 €	20	24.5	150	16
25 x 3/4"	16	812 06 2525 2	14,14 €	20	24.5	150	16

PP-R Dişi Çiftli Batarya Bağlantısı

PP-R Female Double Battery Connection

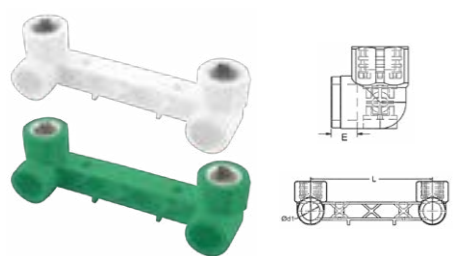

Çap Dia	Basınç Pn	Kod Code	Fiyat (Adet) Price (Pcs)	Koli/Adet Box/Pcs	d1	L	E
20 x 1/2"	16	803 80 020 2	6,66 €	25	19.5	150	14.5
25 x 1/2"	16	803 80 025 2	9,01 €	20	24.5	150	16

PP-R Erkek Çiftli Batarya Bağlantısı - Levha Tip

PP-R Male Double Battery Connection - Slab

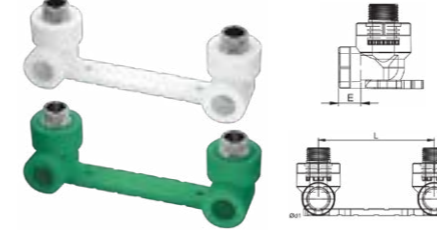

Çap Dia	Basınç Pn	Kod Code	Fiyat (Adet) Price (Pcs)	Koli/Adet Box/Pcs	d1	L	E
20 x 1/2"	16	812 07 2020 2	8,72 €	20	19.5	150	14.5
20 x 3/4"	16	812 07 2025 2	15,84 €	20	19.5	150	14.5
25 x 1/2"	16	812 07 2520 2	11,80 €	20	24.5	150	16
25 x 3/4"	16	812 07 2525 2	14,14 €	20	24.5	150	16

PP-R Dişi Çiftli Batarya Bağlantısı - Levha Tip

PP-R Female Double Battery Connection - Slab



Çap Dia	Basınç Pn	Kod Code	Fiyat (Adet) Price (Pcs)	Koli/Adet Box/Pcs	d1	L	E
20 x 1/2"	16	812 08 2020 2	6,66 €	25	19.5	150	14.5
20 x 3/4"	16	812 08 2025 2	12,09 €	25	19.5	150	14.5
25 x 1/2"	16	812 08 2520 2	9,01 €	20	24.5	150	16
25 x 3/4"	16	812 08 2525 2	10,80 €	20	24.5	150	16

PP-R Ayarlı Batarya

PP-R Adjustable Battery

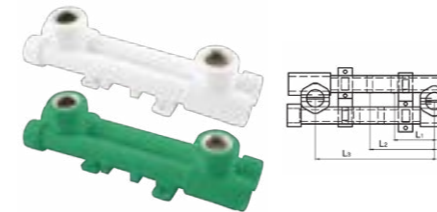

Çap Dia	Basınç Pn	Kod Code	Fiyat (Adet) Price (Pcs)	Koli/Adet Box/Pcs	d1	L1	L2	L3	E
20 x 1/2"	16	803 70 020 2	6,81 €	15	19.5	105	135	150	14.5
25 x 1/2"	16	803 70 025 2	9,97 €	15	24.5	105	135	150	16

PP-R Erkek Taharet Bağlantısı - Çift Giriş

PP-R Male Bidet Battery - Dual

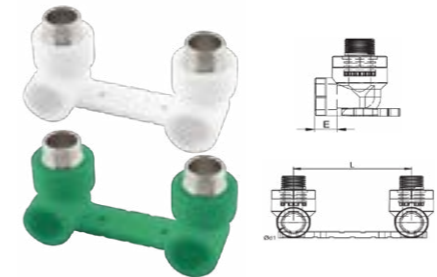

Çap Dia	Basınç Pn	Kod Code	Fiyat (Adet) Price (Pcs)	Koli/Adet Box/Pcs	d1	L	E
20 x 1/2"	16	812 09 2020 2	7,84 €	30	19.5	100	14.5
20 x 3/4"	16	812 09 2025 2	11,65 €	30	19.5	100	14.5
25 x 1/2"	16	812 09 2520 2	9,37 €	25	24.5	100	16
25 x 3/4"	16	812 09 2525 2	11,09 €	25	24.5	100	16

PP-R Dişi Taharet Bağlantısı - Çift Giriş

PP-R Female Bidet Battery - Dual

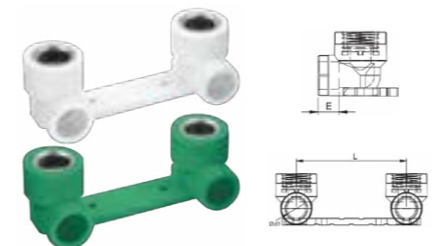

Çap Dia	Basınç Pn	Kod Code	Fiyat (Adet) Price (Pcs)	Koli/Adet Box/Pcs	d1	L	E
20 x 1/2"	16	803 80 020 2	5,70 €	30	19.5	100	14.5
25 x 1/2"	16	803 80 025 2	7,32 €	25	24.5	100	16
25 x 3/4"	16	803 81 025 2	8,78 €	25	24.5	100	16

PP-R Erkek Taharet Bağlantısı
PP-R Male Bidet Battery

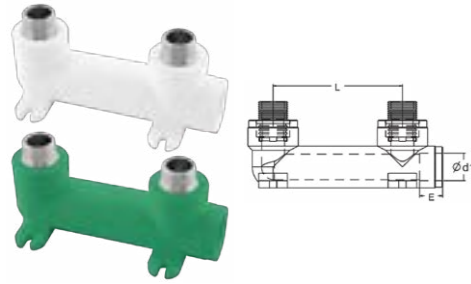

Çap Dia	Basınç Pn	Kod Code	Fiyat (Adet) Price (Pcs)	Koli/Adet Box/Pcs	d1	L	E
20 x 1/2"	16	803 60 020 2	7,84 €	30	19.5	90	14.5
25 x 1/2"	16	803 60 025 2	9,37 €	25	24.5	90	16

PP-R Dişi Taharet Bağlantısı
PP-R Female Bidet Battery

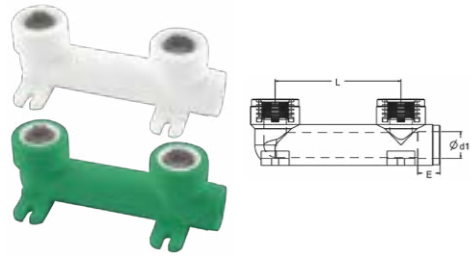

Çap Dia	Basınç Pn	Kod Code	Fiyat (Adet) Price (Pcs)	Koli/Adet Box/Pcs	d1	L	E
20 x 1/2"	16	802 80 020 2	5,70 €	35	19.5	90	14.5
25 x 1/2"	16	802 80 025 2	7,32 €	25	24.5	90	16

PP-R Erkek Te
PP-R Male Tee

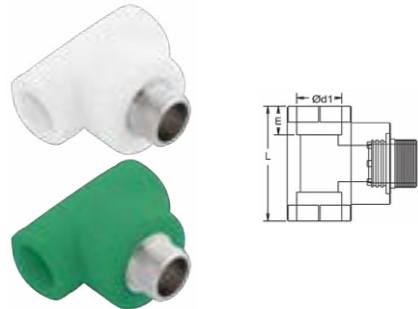

Çap Dia	Basınç Pn	Kod Code	Fiyat (Adet) Price (Pcs)	Koli/Adet Box/Pcs	d1	L	E
20 x 1/2"	16	813 00 2020 2	2,69 €	100	19.5	52	14.5
20 x 3/4"	16	813 00 2025 2	3,77 €	75	19.5	52	14.5
25 x 1/2"	16	813 00 2520 2	3,11 €	75	24.5	59	16
25 x 3/4"	16	813 00 2525 2	3,84 €	50	24.5	59	16
32 x 1/2"	16	813 00 3220 2	7,71 €	30	31.5	70	18
32 x 3/4"	16	813 00 3225 2	7,86 €	30	31.5	44	18
32 x 1"	16	813 00 3232 2	9,69 €	30	31.5	44	18
40 x 1/2"	16	813 00 4020 2	15,71 €	20	39.4	77	20.5
40 x 3/4"	16	813 00 4025 2	18,86 €	20	39.4	77	20.5
40 x 1"	16	813 00 4032 2	22,00 €	20	39.4	82	20.5
50 x 1/2"	16	813 00 5020 2	18,86 €	15	49.4	87	23.5
50 x 3/4"	16	813 00 5025 2	22,00 €	15	49.4	87	23.5
50 x 1"	16	813 00 5032 2	28,29 €	15	49.4	102	23.5
63 x 1/2"	16	813 00 6320 2	28,29 €	8	62.5	120	27.5
63 x 3/4"	16	813 00 6325 2	31,43 €	8	62.5	120	27.5
63 x 1"	16	813 00 6332 2	34,57 €	8	62.5	120	27.5

PP-R Altıköşe Erkek Te
PP-R Male Tee Hexagonal



Çap Dia	Basınç Pn	Kod Code	Fiyat (Adet) Price (Pcs)	Koli/Adet Box/Pcs	d1	L	E
32 x 1"	16	813 01 3232 2	13,12 €	30	31.5	70	18
40 x 1 1/4"	16	813 01 4040 2	21,43 €	15	39.4	97.5	20.5
50 x 1/2"	16	813 01 5020 2	22,68 €	12	49.4	100	23.5
63 x 2"	16	813 01 6363 2	40,16 €	6	62.5	120	27.5

PP-R Dişi Te
PP-R Female Tee

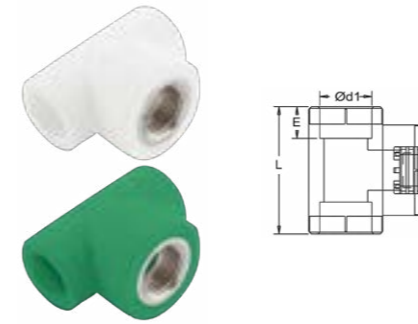

Çap Dia	Basınç Pn	Kod Code	Fiyat (Adet) Price (Pcs)	Koli/Adet Box/Pcs	d1	L	E
20 x 1/2"	16	813 02 2020 2	2,11 €	100	19.5	60	14.5
20 x 3/4"	16	813 02 2025 2	2,88 €	75	19.5	60	14.5
25 x 1/2"	16	813 02 2520 2	2,64 €	75	24.5	52	16
25 x 3/4"	16	813 02 2525 2	3,12 €	50	24.5	66	16
32 x 1/2"	16	813 02 3220 2	4,21 €	30	31.5	80	18
32 x 3/4"	16	813 02 3225 2	4,30 €	30	31.5	80	18
32 x 1"	16	813 02 3232 2	6,40 €	30	31.5	80	18
40 x 1/2"	16	813 02 4020 2	7,11 €	20	39.4	77	20.5
40 x 3/4"	16	813 02 4025 2	7,82 €	20	39.4	77	20.5
40 x 1"	16	813 02 4032 2	17,76 €	20	39.4	82	20.5
50 x 1/2"	16	813 02 5020 2	9,24 €	15	49.4	87	23.5
50 x 3/4"	16	813 02 5025 2	12,44 €	15	49.4	87	23.5
50 x 1"	16	813 02 5032 2	18,48 €	15	49.4	102	23.5
63 x 1/2"	16	813 02 6320 2	12,44 €	9	62.5	120	27.5
63 x 3/4"	16	813 02 6325 2	16,34 €	9	62.5	120	27.5
63 x 1"	16	813 02 6332 2	19,19 €	9	62.5	120	27.5

PP-R Altıköşe Dişi Te
PP-R Female Tee Hexagonal

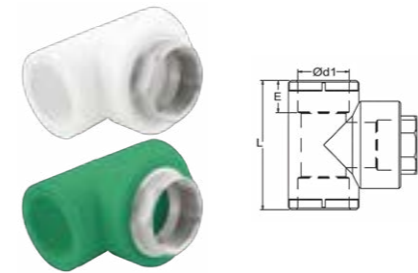

Çap Dia	Basınç Pn	Kod Code	Fiyat (Adet) Price (Pcs)	Koli/Adet Box/Pcs	d1	L	E
32 x 1"	16	813 03 3232 2	6,88 €	30	31.5	80	18
40 x 1 1/4"	16	813 03 4040 2	18,51 €	20	39.4	97.5	20.5
50 x 1/2"	16	813 03 5020 2	19,46 €	16	49.4	100	23.5
63 x 2"	16	813 03 6363 2	34,89 €	8	62.5	120	27.5

PP-R Plastik Küresel Vana
PP-R Ball Valve

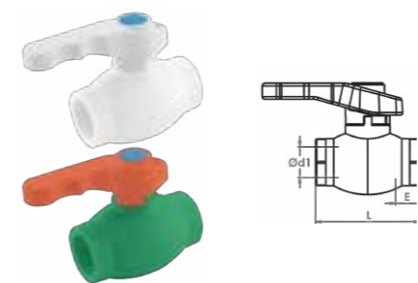

Çap Dia	Basınç Pn	Kod Code	Fiyat (Adet) Price (Pcs)	Koli/Adet Box/Pcs	d1	L	E
20	16	804 00 020 2	4,52 €	50	19.5	66	14.5
25	16	804 00 025 2	6,45 €	40	24.5	73	16
32	16	804 00 032 2	12,89 €	20	31.5	88	18
40	16	804 00 040 2	21,28 €	12	39.4	105	20.5
50	16	804 00 050 2	35,47 €	8	49.4	125	23.5
63	16	804 00 063 2	60,30 €	4	62.5	150	27.5
75	16	804 00 075 2	78,03 €	4	74.2	165	31

PP-R Plastik Küresel Vana - Eko
PP-R Ball Valve - Eco

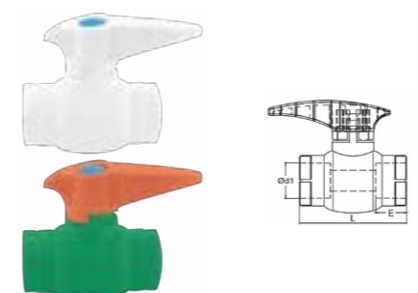

Çap Dia	Basınç Pn	Kod Code	Fiyat (Adet) Price (Pcs)	Koli/Adet Box/Pcs	d1	L	E
20	16	805 20 020 2	3,87 €	90	19.5	59	14.5
25	16	805 20 025 2	5,48 €	60	24.5	64	16
32	16	805 20 032 2	8,38 €	40	31.5	75	18

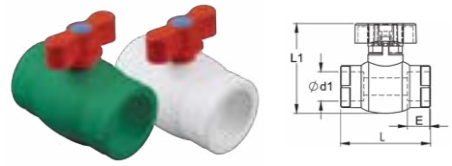
PP-R Plastik Küresel Vana - Kısa
 PP-R Ball Valve (Short Handle)

Çap Dia	Basınç Pn	Kod Code	Fiyat (Adet) Price (Pcs)	Koli/Adet Box/Pcs	d1	L	E	L1
20	16	813 04 020 2	3,87 €	90	19.5	59	14.5	60
25	16	813 04 025 2	5,48 €	60	24.5	64	16	65
32	16	813 04 032 2	8,38 €	40	31.5	75	18	70

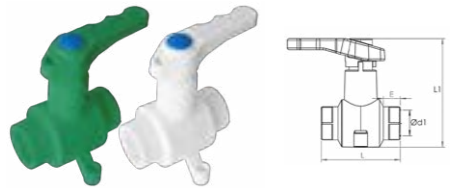
PP-R Küresel Vana - Sıva Altı
 PP-R Undercoating Ball Valve

Çap Dia	Basınç Pn	Kod Code	Fiyat (Adet) Price (Pcs)	Koli/Adet Box/Pcs	d1	L	L1	E
20	16	813 05 020 2	6,84 €	24	19.5	70	98	14.5
25	16	813 05 025 2	9,62 €	20	24.5	75	102	16

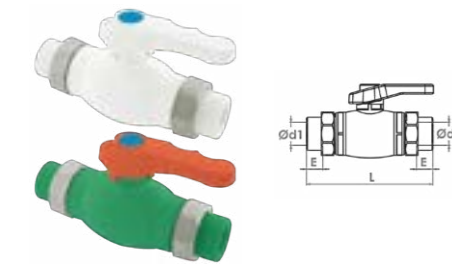
PP-R Küresel Vana - Çift Taraflı
 PP-R Ball Valve with Double Union

Çap Dia	Basınç Pn	Kod Code	Fiyat (Adet) Price (Pcs)	Koli/Adet Box/Pcs	d1	L	E
20	16	813 06 020 2	15,61 €	30	19.5	120	14.5
25	16	813 06 025 2	23,07 €	20	24.5	124	16
32	16	813 06 032 2	33,93 €	15	31.5	140	18

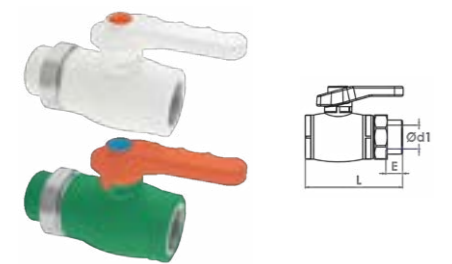
PP-R Dişi Küresel Vana - Tek Taraflı
 PP-R Female Ball Valve with Single Union

Çap Dia	Basınç Pn	Kod Code	Fiyat (Adet) Price (Pcs)	Koli/Adet Box/Pcs	d1	L	E
20	16	813 07 020 2	13,57 €	30	19.5	91	14.5
25	16	813 07 025 2	19,68 €	25	24.5	95	16
32	16	813 07 032 2	29,18 €	20	31.5	109	18

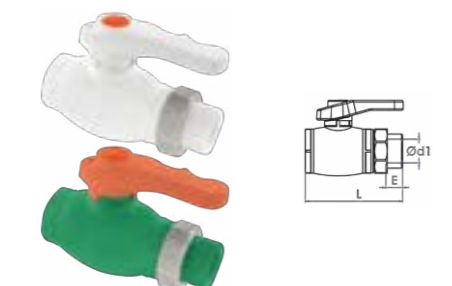
PP-R Küresel Vana - Tek Taraflı
 PP-R Ball Valve with Single Union

Çap Dia	Basınç Pn	Kod Code	Fiyat (Adet) Price (Pcs)	Koli/Adet Box/Pcs	d1	L	E
20	16	813 08 020 2	12,21 €	30	19.5	91	14.5
25	16	813 08 025 2	16,28 €	25	24.5	95	16
32	16	813 08 032 2	23,75 €	20	31.5	109	18

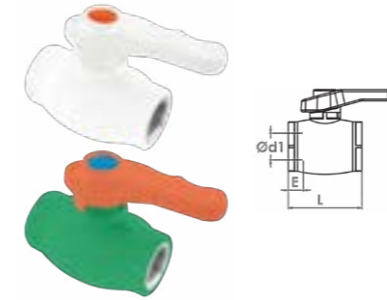
PP-R Dişi Küresel Vana
 PP-R Female Ball Valve

Çap Dia	Basınç Pn	Kod Code	Fiyat (Adet) Price (Pcs)	Koli/Adet Box/Pcs	d1	L	E
20 x 1/2"	16	813 09 020 2	9,50 €	50	19.5	64	14.5
25 x 3/4"	16	813 09 025 2	13,57 €	40	24.5	67	16
32 x 1"	16	813 09 032 2	21,71 €	20	31.5	78	18

PP-R Kollektör Vanası
 PP-R Collector Valve

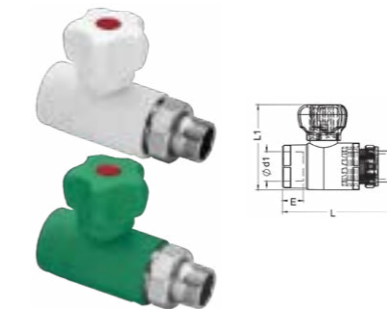

Çap Dia	Basınç Pn	Kod Code	Fiyat (Adet) Price (Pcs)	Koli/Adet Box/Pcs	d1	L	E
25 x 1"	16	814 00 025 2	22,27 €	25	24.5	106	16
32 x 1"	16	814 00 032 2	22,27 €	25	31.5	110	18

PP-R Radyatör Vanası - Düz
 PP-R Radiator Valve Straight

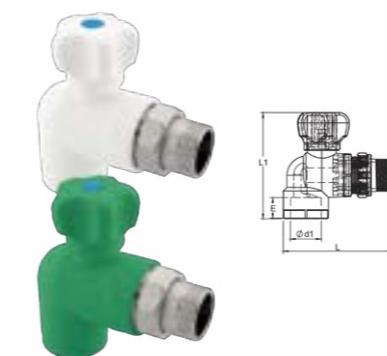
Çap Dia	Basınç Pn	Kod Code	Fiyat (Adet) Price (Pcs)	Koli/Adet Box/Pcs	d1	L1	L	E
20 x 1/2"	16	814 00 2020 2	8,07 €	50	19.5	67	89	14.5
25 x 1/2"	16	814 00 2520 2	10,08 €	50	24.5	67	89	16
25 x 3/4"	16	814 00 2525 2	12,45 €	40	24.5	72	94	16

PP-R Radyatör Vanası - Dirsekli
 PP-R Radiator Valve Elbow

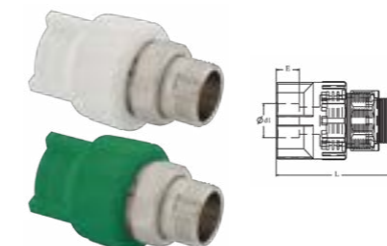
Çap Dia	Basınç Pn	Kod Code	Fiyat (Adet) Price (Pcs)	Koli/Adet Box/Pcs	d1	L1	L	E
20 x 1/2"	16	814 01 2020 2	8,07 €	50	19.5	83	87,5	14.5
25 x 1/2"	16	814 01 2520 2	10,08 €	50	24.5	83	87,5	16
25 x 3/4"	16	814 01 2525 2	12,45 €	40	24.5	90,5	91	16

PP-R Oynar Başlı Radyatör Nipeli
 PP-R Radiator Adaptor

Çap Dia	Basınç Pn	Kod Code	Fiyat (Adet) Price (Pcs)	Koli/Adet Box/Pcs	d1	L	E
20 x 1/2"	16	814 02 2020 2	5,91 €	60	19.5	55	14.5
20 x 3/4"	16	814 02 2025 2	9,67 €	50	19.5	57	14.5
25 x 1/2"	16	814 02 2520 2	6,99 €	60	24.5	57	16
25 x 3/4"	16	814 02 2525 2	9,14 €	50	24.5	57	16

PP-R Oynar Başlı Radyatör Dirseği
PP-R Radiator Elbow Adaptor

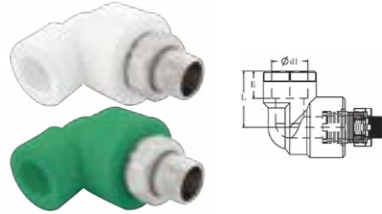

Çap Dia	Basınç Pn	Kod Code	Fiyat (Adet) Price (Pcs)	Koli/Adet Box/Pcs	d1	L	E
20 x 1/2"	16	814 03 2020 2	5,91 €	60	19.5	30	14.5
20 x 3/4"	16	814 03 2025 2	9,67 €	50	19.5	35	14.5
25 x 1/2"	16	814 03 2520 2	6,99 €	60	24.5	40	16
25 x 3/4"	16	814 03 2525 2	9,14 €	50	24.5	40	16

PP-R Kelebek Vana
PP-R Stop Valve

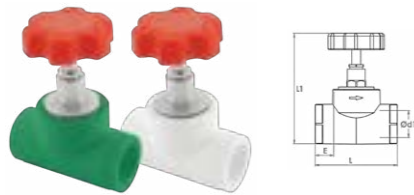

Çap Dia	Basınç Pn	Kod Code	Fiyat (Adet) Price (Pcs)	Koli/Adet Box/Pcs	d1	L	L1	E
20	16	804 90 020 2	6,94 €	40	19.5	73	96	14.5
25	16	804 90 025 2	8,13 €	30	24.5	73	105	16
32	16	804 90 032 2	12,72 €	20	31.5	86	109	18
40	16	804 90 040 2	16,66 €	15	39.4	93	129	20.5

PP-R Lüx Stop Vana
PP-R Lustration Valve

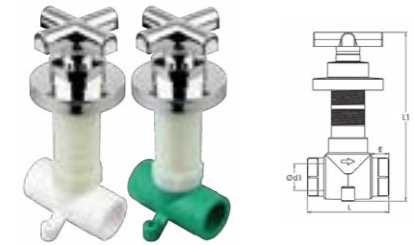

Çap Dia	Basınç Pn	Kod Code	Fiyat (Adet) Price (Pcs)	Koli/Adet Box/Pcs	d1	E	L	L1
20	25	814 04 020 2	13,03 €	15	19.5	14.5	73	138
25	25	814 04 025 2	13,95 €	15	24.5	16	78	138
32	25	814 04 032 2	14,96 €	15	31.5	18	87	143

PP-R Kromlu Ankastr Vana
PP-R Chrome Valve - Plastic Encastre



Çap Dia	Basınç Pn	Kod Code	Fiyat (Adet) Price (Pcs)	Koli/Adet Box/Pcs	d1	L	L1	E
20	25	804 30 020 2	19,05 €	30	19.5	73	93	14.5
25	25	804 30 025 2	22,25 €	25	24.5	73	94	16
32	25	804 30 032 2	28,53 €	25	31.5	86	105	18
40	25	804 30 040 2	33,56 €	20	39.4	93	107	20,5

PP-R Kromlu Vana
PP-R Chrome Valve - Plastic Head



Çap Dia	Basınç Pn	Kod Code	Fiyat (Adet) Price (Pcs)	Koli/Adet Box/Pcs	d1	L	L1	E
20	25	804 20 020 2	22,87 €	25	19.5	73	138	14.5
25	25	804 20 025 2	25,44 €	20	24.5	73	141	16
32	25	804 20 032 2	33,53 €	15	31.5	86	151	18
40	25	804 20 040 2	36,31 €	10	39.4	93	157	20,5

PP-R Kromlu Vana - Mevlana
PP-R Chrome Valve Triangle - Plastic Head



Çap Dia	Basınç Pn	Kod Code	Fiyat (Adet) Price (Pcs)	Koli/Adet Box/Pcs	d1	L	L1	E
20	25	804 10 020 2	22,87 €	25	19.5	73	131	14.5
25	25	804 10 025 2	25,44 €	20	24.5	73	137	16
32	25	804 10 032 2	33,53 €	15	31.5	86	147	18
40	25	804 10 040 2	36,31 €	10	39.4	93	153	20,5

PP-R Kromlu Küresel Vana
PP-R Chrome Ball Valve - Plastic Head



Çap Dia	Basınç Pn	Kod Code	Fiyat (Adet) Price (Pcs)	Koli/Adet Box/Pcs	d1	L	L1	E
20	25	814 05 020 2	16,39 €	25	19.5	67	132	14.5
25	25	814 05 025 2	20,49 €	20	24.5	74	138	16
32	25	814 05 032 2	24,59 €	15	31.5	87	150	18

PP-R Kromlu Küresel Vana - Mevlana
PP-R Chrome Ball Valve Triangle - Plastic Head



Çap Dia	Basınç Pn	Kod Code	Fiyat (Adet) Price (Pcs)	Koli/Adet Box/Pcs	d1	L	L1	E
20	25	814 06 020 2	16,39 €	25	19.5	67	126	14.5
25	25	814 06 025 2	20,49 €	20	24.5	74	133	16
32	25	814 06 032 2	24,59 €	15	31.5	87	148	18

PP-R Bahçe Musluğu
PP-R Garden Tap



Çap Dia	Basınç Pn	Kod Code	Fiyat (Adet) Price (Pcs)	Koli/Adet Box/Pcs	d1	L	L1
1/2"	16	814 07 020 2	7,29 €	40	13.5	74	63

PP-R Çamaşır Makinesi Musluğu
PP-R Washing Machine Tap



Çap Dia	Basınç Pn	Kod Code	Fiyat (Adet) Price (Pcs)	Koli/Adet Box/Pcs	L	L1
1/2-3/4"	16	814 08 2025 2	6,33 €	40	72	39

PP-R Çiftli Musluk Çatalı
PP-R Twin Tap



Çap Dia	Basınç Pn	Kod Code	Fiyat (Adet) Price (Pcs)	Koli/Adet Box/Pcs
3/4"	16	814 09 025 2	2,43 €	100

PP-R Erkek Çekvalf
PP-R Non Return Valve Male



Çap Dia	Basınç Pn	Kod Code	Fiyat (Adet) Price (Pcs)	Koli/Adet Box/Pcs	d1	d2	L	E
20	25	815 00 020 2	3,96 €	75	19.5	20,3	67	14.5
25	25	815 00 025 2	6,18 €	50	24.5	25,3	71	16
32	25	815 00 032 2	10,02 €	25	31.5	32,3	100	18

PP-R Dişi Çekvalf
PP-R Non Return Valve Female



Çap Dia	Basınç Pn	Kod Code	Fiyat (Adet) Price (Pcs)	Koli/Adet Box/Pcs	d1	L	E
20	25	815 01 020 2	3,96 €	75	19.5	67	14.5
25	25	815 01 025 2	6,18 €	50	24.5	71	16
32	25	815 01 032 2	10,02 €	25	31.5	100	18

PP-R Erkek Vana
PP-R Valve Male



Çap Dia	Basınç Pn	Kod Code	Fiyat (Adet) Price (Pcs)	Koli/Adet Box/Pcs	d1	d2	L	E
20	25	815 02 020 2	10,72 €	30	19.5	20.3	78	14.5
25	25	815 02 025 2	12,51 €	30	24.5	25.3	88	16
32	25	815 02 032 2	21,28 €	15	31.5	32.3	106	18

PP-R Dişi Vana
PP-R Valve Female



Çap Dia	Basınç Pn	Kod Code	Fiyat (Adet) Price (Pcs)	Koli/Adet Box/Pcs	d1	L	E
20	25	815 03 020 2	10,72 €	30	19.5	78	14.5
25	25	815 03 025 2	12,51 €	30	24.5	88	16
32	25	815 03 032 2	21,28 €	15	31.5	106	18

PP-R Erkek Filtre
PP-R Male Filter



Çap Dia	Basınç Pn	Kod Code	Fiyat (Adet) Price (Pcs)	Koli/Adet Box/Pcs	d1	d2	L	E
20	25	815 04 020 2	3,96 €	75	20.3	19.5	78	14.5
25	25	815 04 025 2	6,18 €	50	25.3	24.5	88	16
32	25	815 04 032 2	10,02 €	25	32.3	31.5	106	18

PP-R Dişi Filtre
PP-R Female Filter



Çap Dia	Basınç Pn	Kod Code	Fiyat (Adet) Price (Pcs)	Koli/Adet Box/Pcs	d1	L	E
20	25	815 05 020 2	3,96 €	75	19.5	78	14.5
25	25	815 05 025 2	6,18 €	50	24.5	88	16
32	25	815 05 032 2	10,02 €	25	31.5	106	18

PP-R Kuyruklu Erkek Nipel
PP-R Tailed Male Nipple

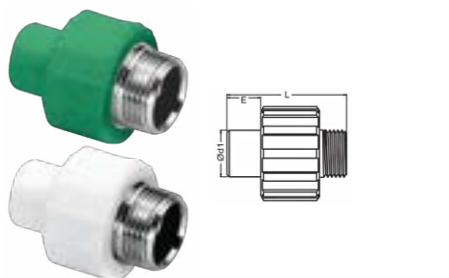

Çap Dia	Basınç Pn	Kod Code	Fiyat (Adet) Price (Pcs)	Koli/Adet Box/Pcs	d1	L	E
20 x 1/2"	25	815 06 2020 2	2,89 €	125	20.3	52	14.5
20 x 3/4"	25	815 06 2025 2	4,87 €	100	20.3	54	14.5
25 x 1/2"	25	815 06 2520 2	3,43 €	125	25.3	52	16
25 x 3/4"	25	815 06 2525 2	4,51 €	75	25.3	54	16

PP-R Kuyruklu Dişi Nipel
PP-R Tailed Female Nipple

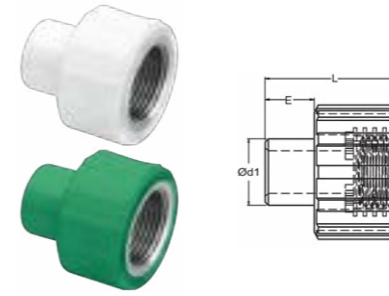

Çap Dia	Basınç Pn	Kod Code	Fiyat (Adet) Price (Pcs)	Koli/Adet Box/Pcs	d1	L	E
20 x 1/2"	25	815 07 2020 2	2,31 €	150	20.3	41	14.5
20 x 3/4"	25	815 07 2025 2	3,37 €	150	20.3	41	14.5
25 x 1/2"	25	815 07 2520 2	2,65 €	150	25.3	41	16
25 x 3/4"	25	815 07 2525 2	3,13 €	150	25.3	41	16

PP-R Hareketli Nipel
PP-R Nipple with Nut



Çap Dia	Basınç Pn	Kod Code	Fiyat (Adet) Price (Pcs)	Koli/Adet Box/Pcs	d1	E
20 x 1/2"	25	815 08 2020 2	4,08 €	175	19.5	14.5
20 x 3/4"	25	815 08 2025 2	4,90 €	125	19.5	14.5
25 x 1/2"	25	815 08 2520 2	4,67 €	125	24.5	16
25 x 3/4"	25	815 08 2525 2	5,42 €	125	24.5	16
25 x 1"	25	815 08 2532 2	8,67 €	80	24.5	16
32 x 3/4"	25	815 08 3225 2	5,96 €	75	31.5	18
32 x 1"	25	815 08 3232 2	10,20 €	60	31.5	18
32 x 1" 1/4"	25	815 08 3240 2	12,75 €	50	31.5	18

PP-R Hareketli Dirsek
PP-R Elbow with Nut

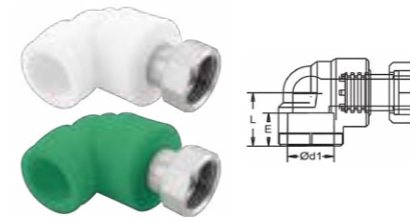

Çap Dia	Basınç Pn	Kod Code	Fiyat (Adet) Price (Pcs)	Koli/Adet Box/Pcs	d1	L	E
20 x 1/2"	25	815 09 2020 2	4,35 €	120	19.5	30	14.5
20 x 3/4"	25	815 09 2025 2	5,17 €	80	19.5	30	14.5
25 x 3/4"	25	815 09 2525 2	5,50 €	80	24.5	32	16
25 x 1"	25	815 09 2532 2	8,94 €	75	24.5	32	16
32 x 3/4"	25	815 09 3225 2	6,15 €	50	31.5	38	18
32 x 1"	25	815 09 3232 2	10,20 €	50	31.5	38	18
32 x 1" 1/4"	25	815 09 3240 2	12,75 €	40	31.5	38	18

PP-R Hareketli Te
PP-R Tee with Nut

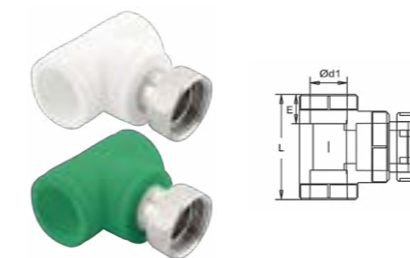

Çap Dia	Basınç Pn	Kod Code	Fiyat (Adet) Price (Pcs)	Koli/Adet Box/Pcs	d1	L	E
20 x 1/2"	25	816 00 2020 2	4,35 €	125	19.5	30	14.5
20 x 3/4"	25	816 00 2025 2	5,17 €	80	19.5	30	14.5
25 x 3/4"	25	816 00 2525 2	5,50 €	80	24.5	32	16
25 x 1"	25	816 00 2532 2	8,94 €	40	24.5	32	16
32 x 1"	25	816 00 3232 2	10,20 €	30	31.5	38	18
32 x 1" 1/4"	25	816 00 3240 2	12,75 €	30	31.5	38	18

PP-R PE-X Nipeli - Kuyruklu
PP-R PE-X Tail Adapter

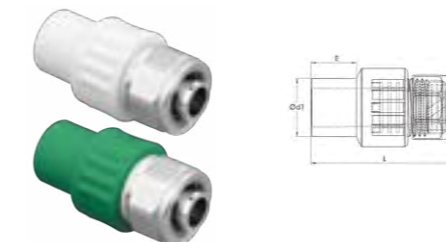

Çap Dia	Basınç Pn	Kod Code	Fiyat (Adet) Price (Pcs)	Koli/Adet Box/Pcs	d1	L	E
20x1/2"x16	25	816 01 2020 2	5,42 €	200	20.3	54	14.5

PP-R Oynar Başlı Erkek Rakor
PP-R Transition Union Male

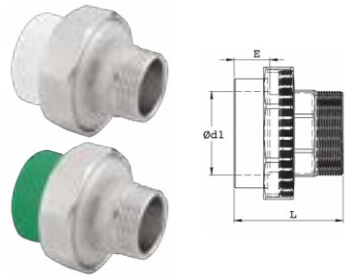

Çap Dia	Basınç Pn	Kod Code	Fiyat (Adet) Price (Pcs)	Koli/Adet Box/Pcs	d1	L	E
20 x 1/2"	25	816 02 2020 2	4,29 €	175	19.5	45	14.5
20 x 3/4"	25	816 02 2025 2	5,66 €	150	19.5	45	14.5
20 x 1"	25	816 02 2032 2	7,29 €	160	19.5	50	14.5
25 x 1/2"	25	816 02 2520 2	7,08 €	120	24.5	46	16
25 x 3/4"	25	816 02 2525 2	7,13 €	100	24.5	49	16
25 x 1"	25	816 02 2532 2	8,84 €	100	24.5	50	16
32 x 1/2"	25	816 02 3220 2	9,16 €	80	31.5	49	18
32 x 3/4"	25	816 02 3225 2	9,76 €	80	31.5	49	18
32 x 1"	25	816 02 3232 2	9,89 €	75	31.5	52	18
32 x 1 1/4"	25	816 02 4032 2	14,20 €	60	31.5	56	18
40 x 1 1/4"	25	816 02 4040 2	16,37 €	40	39.4	59	20.5
50 x 1 1/2"	25	816 02 5050 2	30,46 €	25	49.4	62	23.5
63 x 2"	25	816 02 6363 2	57,58 €	16	62.5	72	27.5
75 x 2 1/2"	25	816 02 7575 2	89,41 €	6	74.2	97	31
90 x 3"	25	816 02 9090 2	166,54 €	3	89.2	117	35.5
110 x 4"	25	816 02 0110 2	249,98 €	2	109	134	41.5

PP-R PE-X Nipel - Dişi
PP-R PE-X Female Adapter

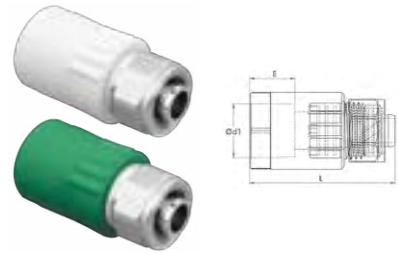

Çap Dia	Basınç Pn	Kod Code	Fiyat (Adet) Price (Pcs)	Koli/Adet Box/Pcs	d1	L	E
20x1/2"x16	25	816 03 2020 2	5,42 €	200	19.5	54	14.5

PP-R Oynar Başlı Dişi Rakor
PP-R Transition Union Female

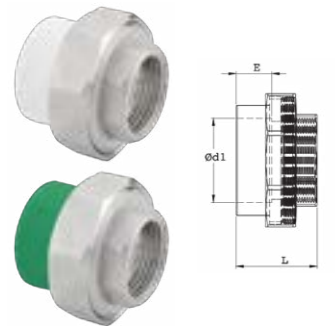

Çap Dia	Basınç Pn	Kod Code	Fiyat (Adet) Price (Pcs)	Koli/Adet Box/Pcs	d1	L	E
20 x 1/2"	25	816 04 2020 2	4,14 €	200	19.5	38	14.5
20 x 3/4"	25	816 04 2025 2	4,90 €	175	19.5	38	14.5
20 x 1"	25	816 04 2032 2	6,18 €	175	19.5	39	14.5
25 x 1/2"	25	816 04 2520 2	6,55 €	125	24.5	37	16
25 x 3/4"	25	816 04 2525 2	6,23 €	125	24.5	38	16
25 x 1"	25	816 04 2532 2	7,10 €	100	24.5	40	16
32 x 1/2"	25	816 04 3220 2	8,44 €	90	31.5	42	18
32 x 3/4"	25	816 04 3225 2	8,83 €	80	31.5	42	18
32 x 1"	25	816 04 3232 2	8,17 €	80	31.5	42	18
32 x 1 1/4"	25	816 04 4032 2	11,54 €	70	31.5	46	18
40 x 1 1/4"	25	816 04 4040 2	14,70 €	50	39.4	48	20.5
50 x 1 1/2"	25	816 04 5050 2	24,14 €	25	49.4	48	23.5
63 x 2"	25	816 04 6363 2	50,32 €	16	62.5	58	27.5
75 x 2 x 1/2"	25	816 04 7575 2	82,33 €	9	74.2	72	31
90 x 3"	25	816 04 9090 2	150,87 €	6	89.2	78	35.5
110 x 4"	25	816 04 0110 2	226,15 €	2	109	89	41.5

PP-R Hareketli Erkek Nipel - Hafif Tip
PP-R Transition Nipple Male

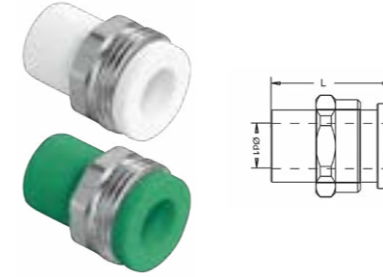

Çap Dia	Basınç Pn	Kod Code	Fiyat (Adet) Price (Pcs)	Koli/Adet Box/Pcs	d1	L
20 x 3/4"	25	816 05 2025 2	1,58 €	200	20.3	38
25 x 1"	25	816 05 2532 2	2,90 €	150	25.3	43

PP-R Hareketli Dişi Nipel - Hafif Tip
PP-R Transition Nipple Female

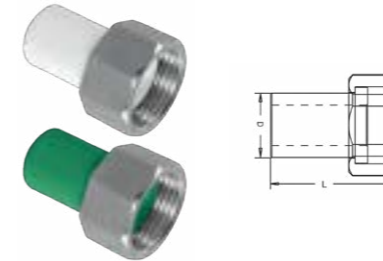

Çap Dia	Basınç Pn	Kod Code	Fiyat (Adet) Price (Pcs)	Koli/Adet Box/Pcs	d1	L
20 x 3/4"	25	816 06 2025 2	2,51 €	200	20.3	38
25 x 1"	25	816 06 2532 2	3,80 €	150	25.3	43

PP-R Su Sayaç Nipel
PP-R Water Meter Nipple

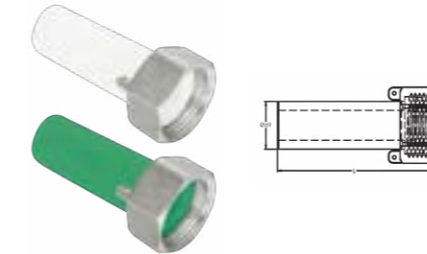

Çap Dia	Basınç Pn	Kod Code	Fiyat (Adet) Price (Pcs)	Koli/Adet Box/Pcs	d1	L
20 x 3/4"	25	816 07 2025 2	2,51 €	200	20.3	68
25 x 1"	25	816 07 2532 2	3,80 €	150	25.3	68

PP-R Çift Taraflı Kaynaklı Rakor
PP-R Transition Union Two Side Welded

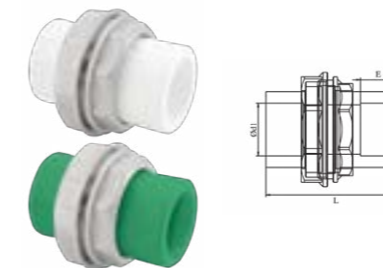

Çap Dia	Basınç Pn	Kod Code	Fiyat (Adet) Price (Pcs)	Koli/Adet Box/Pcs	d1	L	E
20	25	816 08 020 2	6,50 €	100	19.5	14.5	56
25	25	816 08 025 2	9,64 €	75	24.5	16	59
32	25	816 08 032 2	11,94 €	50	31.5	18	60
40	25	816 08 040 2	25,14 €	30	39.4	20.5	59
50	25	816 08 050 2	38,97 €	25	49.4	23.5	59
63	25	816 08 063 2	74,17 €	14	62.5	27.5	72

PP-R Plastik Çift Taraflı Kaynaklı Rakor

PP-R Union

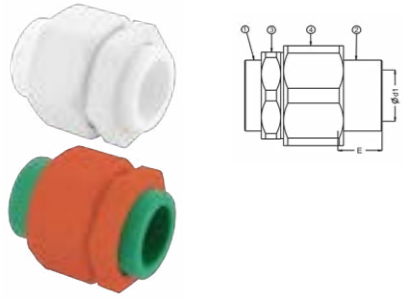

Çap Dia	Basınç Pn	Kod Code	Fiyat (Adet) Price (Pcs)	Koli/Adet Box/Pcs	d1	E
20	25	816 09 020 2	3,28 €	100	19.5	14.5
25	25	816 09 025 2	4,74 €	60	24.5	16
32	25	816 09 032 2	6,56 €	50	31.5	18

PP-R Plastik Çift Taraflı Kaynaklı Rakor PN 16

PP-R Union PN 16

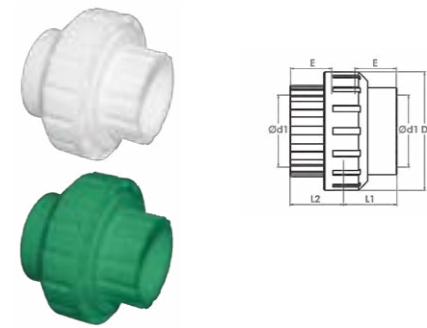

Çap Dia	Basınç Pn	Kod Code	Fiyat (Adet) Price (Pcs)	Koli/Adet Box/Pcs	d1	D	E	L1	L2
20	16	816 10 020 2	2,42 €	200	19.5	43	14.5	21.5	24.3
25	16	816 10 025 2	3,50 €	125	24.5	54	16	27.6	25.7
32	16	816 10 032 2	4,85 €	100	31.5	60	18	25.2	30.1
40	16	816 10 040 2	9,42 €	50	39.4	74	20.5	29	39
50	16	816 10 050 2	13,46 €	30	49.4	92	23.5	34	45
63	16	816 10 063 2	16,82 €	16	62.5	118	27.5	41	55
75	16	816 10 075 2	52,76 €	10	74.2	130	31	47	53
90	16	816 10 090 2	73,41 €	6	89.2	181	35.5	56	61
110	16	816 10 110 2	96,35 €	3	109	210	41.5	65	71

PP-R Plastik Oynar Başlı Erkek Rakor

PP-R Plastic Transition Union Male

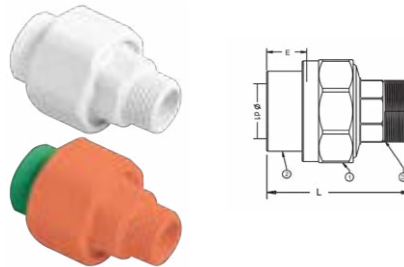

Çap Dia	Basınç Pn	Kod Code	Fiyat (Adet) Price (Pcs)	Koli/Adet Box/Pcs	d1	L	E
20 x 1/2"	25	816 11 020 2	2,75 €	100	19.5	60	14.5
25 x 3/4"	25	816 11 025 2	3,98 €	70	24.5	65	16
32 x 1"	25	816 11 032 2	5,50 €	50	31.5	67	18

PP-R Plastik Oynar Başlı Dişi Rakor

PP-R Plastic Transition Union Female

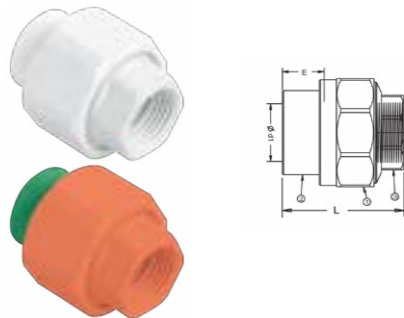

Çap Dia	Basınç Pn	Kod Code	Fiyat (Adet) Price (Pcs)	Koli/Adet Box/Pcs	d1	L	E
20 x 1/2"	25	816 12 020 2	2,75 €	100	19.5	50	14.5
25 x 3/4"	25	816 12 025 2	3,98 €	80	24.5	55	16
32 x 1"	25	816 12 032 2	5,50 €	60	31.5	57	18

YEDEK PARÇALAR SPARE PARTS



U-PVC Kelebek Vana Yedek Parça Listesi
U-PVC Butterfly Valve Spare List

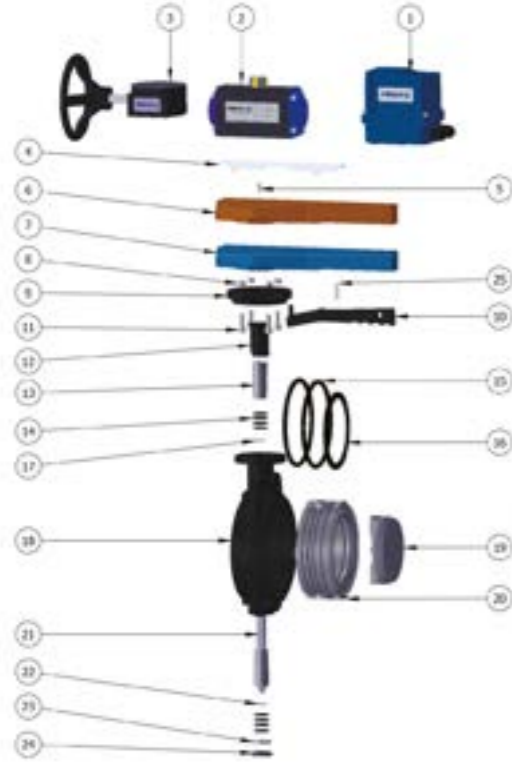

No	Parça Part	Malzeme Material	Adet QTY
1	Elektrikli Aktuatör		1
2	Pnomatik Aktuatör		1
3	Direksiyon		1
4	Kol Kapağı / Lever Clip	PVC	1
5	Civata / Screw	INOX	1
6	Kol / Handle (Su Vanası Kullanımı)	ABS	1
7	Kol / Handle (Asit Vanası Kullanımı)	ABS	1
8	Somun / Nut	INOX	4
9	Çark / Index Plate	PP GF	1
10	Mandal / Lever Catch	PP GF	1
11	Civata / Screw	INOX	4
12	Stop Parçası / End Stop	PP GF	1
13	Pim / Step	U-PVC / PP / C-PVC	1
14	Pim O-Ring / Step O-Ring	EPDM / FPM	8
15	İç Gövde Alın O-Ring	EPDM / FPM	2
16	İç Gövde O-Ring / Inner Seal	EPDM / FPM	1
17	Segman / Retaining Rings	INOX	1
18	Dış Gövde / Body	PP GF	1
19	Klape / Disc	U-PVC / PP / C-PVC	1
20	İç Gövde / Inner Body	U-PVC / PP / C-PVC	1
21	Şaft / Steel Shaft	STEEL	1
22	Segman / Retaining rings	INOX	1
23	Pul / Washer	INOX	1
24	Tapa / Cap	PP GF	1
25	Yay / Spring	INOX	1



No	Ø63 Kod /Code	Fiyat (Adet) Price (Pcs)	Ø75 Kod /Code	Fiyat (Adet) Price (Pcs)	Ø90 Kod /Code	Fiyat (Adet) Price (Pcs)	Ø110 Kod /Code	Fiyat (Adet) Price (Pcs)	Ø125-Ø140 Kod /Code	Fiyat (Adet) Price (Pcs)	
1	700006329	251,90 €	700007529	251,90 €	700009026	251,90 €	700009026	251,90 €	700011026	251,90 €	
2	700040027	260,96 €	700007527	256,96 €	700009027	256,96 €	700009027	256,96 €	700011027	283,88 €	
3	700040028	30,00 €	700007528	30,00 €	700009028	30,00 €	700009028	30,00 €	700011028	30,00 €	
4	202050902	0,90 €	202050902	0,90 €	202050902	0,90 €	202050902	0,90 €	202050902	0,90 €	
5	2021501409	2,10 €	2021501409	2,10 €	2021501409	2,10 €	2021501409	2,10 €	2021501409	2,10 €	
6	291139904	13,00 €	291139904	13,00 €	291139904	13,00 €	291139904	13,00 €	291131104	15,00 €	
7	291130905	13,00 €	29113905	13,00 €	29113905	13,00 €	29113905	13,00 €	291131105	15,00 €	
8	201151969	0,50 €	201151969	0,50 €	201151969	0,50 €	201151969	0,50 €	201151969	0,50 €	
9	400267952	6,80 €	400267952	6,80 €	400267952	6,80 €	400267952	6,80 €	400267952	6,80 €	
10	400267962	6,00 €	400267962	6,00 €	400267962	6,00 €	400267962	6,00 €	400261112	7,00 €	
11	201151979	0,30 €	201151979	0,30 €	201151979	0,30 €	201151979	0,30 €	201151979	0,30 €	
12	400267982	1,50 €	400267982	1,50 €	400267982	1,50 €	400267182	1,50 €	400267182	1,50 €	
13	201019995	0,10 €	201019995	0,10 €	201019995	0,10 €	201011115	0,10 €	201011115	0,10 €	
EPDM	14	201999999	0,75 €	201999999	0,75 €	201999999	0,75 €	201999998	1,00 €	201999998	1,00 €
FPM	14	201999900	5,25 €	201999900	5,25 €	201999900	5,25 €	201999990	7,00 €	201999990	7,00 €
EPDM	15	201030637	1,75 €	201030757	2,50 €	202030909	3,00 €	202031109	4,00 €	K00203779	5,00 €
FPM	15	201030639	12,25 €	201030758	17,50 €	205030909	21,00 €	406031109	28,00 €	K0023770	35,00 €
EPDM	16	201020639	1,75 €	201020759	2,50 €	201020909	3,00 €	201021109	4,00 €	201021409	5,00 €
FPM	16	201020630	12,25 €	201020750	17,50 €	201020900	21,00 €	201021100	28,00 €	201021400	35,00 €
17	102310209	6,80 €	102310209	6,80 €	102310209	6,80 €	102310209	6,80 €	102310209	6,80 €	
18	400267632	13,00 €	400267752	13,00 €	400267942	13,00 €	400110942	14,00 €	401251402	18,00 €	
19	201137634	7,00 €	201137754	7,00 €	201137974	7,00 €	201137104	9,00 €	201137105	11,00 €	
20	201010635	20,00 €	201010755	20,00 €	201010905	20,00 €	201011105	24,00 €	212514005	28,00 €	
21	201040634	13,00 €	201040754	13,00 €	201040904	13,00 €	201041104	15,00 €	201041254	15,00 €	
22	102310248	0,80 €	102310248	0,80 €	102310248	0,80 €	102310248	0,80 €	102310699	1,20 €	
23	102310259	0,15 €	102310259	0,15 €	102310259	0,15 €	102310259	0,15 €	102310259	0,15 €	
24	400267972	2,00 €	400267972	2,00 €	400267972	2,00 €	400267172	4,00 €	400267172	4,00 €	
25	271351979	1,50 €	271351979	1,50 €	271351979	1,50 €	271351979	1,50 €	271351979	1,50 €	

No	Ø160 Kod /Code	Fiyat (Adet) Price (Pcs)	Ø200-Ø225 Kod /Code	Fiyat (Adet) Price (Pcs)	Ø250-Ø280 Kod /Code	Fiyat (Adet) Price (Pcs)	Ø315 Kod /Code	Fiyat (Adet) Price (Pcs)	Ø400 Kod /Code	Fiyat (Adet) Price (Pcs)	
1	700016026	668,08 €	700020026	668,08 €	700025026	750,00 €	700031526	950,00 €	700040026	1.150,00 €	
2	700016027	471,24 €	700020027	519,18 €	700025027	685,95 €	700031527	685,95 €	700040027	785,00 €	
3	700016028	30,00 €	700020028	30,00 €	700025028	50,00 €	700031528				
4	202050902	0,90 €	202051102	2,00 €	202051102	2,00 €	202053152	13,50 €			
5	2021501409	2,10 €	2021501409	2,10 €	2021501409	2,10 €	2021501409	2,10 €			
6	291131104	15,00 €	2911392004	24,00 €	2911392004	24,00 €	2911393154	162,00 €			
7	291131105	15,00 €	291132005	24,00 €	291132005	24,00 €	291133154	162,00 €			
8	201151969	0,50 €	201151969	0,50 €	201151969	0,50 €	201151969	0,50 €			
9	400267952	6,80 €	400267952	6,80 €	400267952	6,80 €	400267952	6,80 €			
10	400261112	7,00 €	400262002	11,00 €	400262002	11,00 €	400263152	74,25 €			
11	201151979	0,30 €	201151979	0,30 €	201151979	0,30 €	201151979	0,30 €			
12	400267182	1,50 €	400267200	1,50 €	400267200	1,50 €	400267200	1,50 €			
13	201011115	0,10 €	201012005	0,50 €	202502805	1,35 €	201019991	3,38 €			
EPDM	14	201999998	1,00 €	2010322542	1,50 €	2010322542	1,50 €	201031595	10,13 €		
FPM	14	201999990	7,00 €	2010322000	15,00 €	2010322000	15,00 €	201031590	33,00 €		
EPDM	15	K002037799	6,00 €	2010322549	7,00 €	2010325050	18,90 €	2010331549	47,25 €		
FPM	15	K002037790	42,00 €	2010322540	49,00 €	2010325040	115,00 €	2010331540	260,81 €		
EPDM	16	201021609	6,00 €	2010322544	7,00 €	201032899	18,90 €	2010331544	47,25 €		
FPM	16	201021600	42,00 €	2010322500	49,00 €	201032800	115,00 €	201033150	260,81 €		
17	102310209	6,80 €	1023101029	13,00 €	1023101029	13,00 €	1023101029	13,00 €			
18	40160942	29,00 €	401252002	48,00 €	401252502	129,60 €	400315942	324,00 €			
19	201137106	18,00 €	20137205	21,00 €	20132804	56,70 €	201133154	141,75 €			
20	201016005	45,00 €	212520005	75,00 €	201028005	202,50 €	201013156	506,25 €			
21	201041604	24,00 €	201042004	24,00 €	201042804	64,80 €	201043154	162,00 €			
22	102310699	1,20 €	1023101129	2,10 €	1023101129	2,10 €	1023101139	14,18 €			
23	102310259	0,15 €	201120225	0,15 €	201120225	0,15 €	2011200315	1,01 €			
24	400267172	4,00 €	400267225	8,00 €	400267225	8,00 €	400267315	54,00 €			
25	271351979	1,50 €	271351979	1,50 €	271351979	1,50 €	271351979	1,50 €	271351979	1,50 €	

U-PVC Küresel Vana Yedek Parça Listesi
 U-PVC True Union Ball Valves Spare Parts List

No	Parça Part	Malzeme Material	Adet QTY
1	Pnömatik Akuator		1
2	Elektrikli Akuator		1
3	Kol Kapağı / Handle Cover	PVC	1
4	Civata / Screw	INOX	1
5	Kol / Handle (ASİT VANA KOL)	ABS	1
6	Kol / Horle / (SU VANA KOL)	ABS	1
7	Somun / Nut	INOX	4
8	Çark / Index Plate	PP GF	1
9	Mandal / Lever Catch	PP GF	1
10	Adaptör Ara Parça	U-PVC	1
11	ISO 4762 M8 x 25 --- 255	INOX	4
12	Kol Kapağı / Handle Cover	ABS	1
13	Civata / Screw	INOX	1
14	Kol Handle (ASİT)	ABS	1
15	Kol Handle (SU)	ABS	1
16	Pim Uzatma Parçası	U-PVC	1
17	Pim / Step	U-PVC	1
18	Pim O-Ringi / Step O-Ring	EPDM / FPM	2
19	Vida / Screw	INOX	4

No	Parça Part	Malzeme Material	Adet QTY
20	Flanş / Flange	U-PVC	2
21	Kole Ara Parça	U-PVC	2
22	Somun / Union Nut	U-PVC	2
23	Adaptör	U-PVC	4
24	Gövde O-Ringi / Body O-Ring	EPDM / FPM	2
25	Gövde / Body	U-PVC	1
26	Conta / Gasket	HDPE	2
27	Küre / Ball	U-PVC	1
28	Conta Altı O-Ring / Backing Seals	EPDM / FPM	2
29	Dayama O-Ring	EPDM / FPM	1
30	Küre Dayama / Union Brush	U-PVC	1
31	Dış Dış Adaptör	BRASS	1
32	İç Dış Adaptör	BRASS	1
33	İç Dişli Adaptör	U-PVC	1
34	Dış Dişli Adaptör	U-PVC	1
35	Adaptör	HDPE	1
36	Dış Yapıştırma Adaptör	U-PVC	1
37	Hortum Adaptörü	U-PVC	1



No	Ø20 Kod /Code	Fiyat (Adet) Price (Pcs)	Ø25 Kod /Code	Fiyat (Adet) Price (Pcs)	Ø32 Kod /Code	Fiyat (Adet) Price (Pcs)	Ø40 Kod /Code	Fiyat (Adet) Price (Pcs)	Ø50 Kod /Code	Fiyat (Adet) Price (Pcs)
1	700002026	89,70 €	700002526	89,70 €	700003226	89,70 €	700004026	104,65 €	700006326	149,50 €
2	700002027	269,1 €	700002527	269,1 €	700003227	269,10 €	700004027	269,10 €	700005027	269,10 €
3										
4										
5										
6										
7										
8										
9										
10										
11										
12	202050202	0,50 €	202050202	0,50 €	202050322	0,60 €	202050402	0,82 €	202050502	0,86 €
13	100304199	0,50 €	100304199	0,50 €	100304199	0,50 €	100304199	0,50 €	100300749	0,80 €
14	205040202	1,10 €	205040202	1,10 €	205040322	1,25 €	205040402	1,50 €	205040502	1,60 €
15	202040202	1,10 €	202040202	1,10 €	202040322	1,25 €	202040402	1,50 €	202040502	1,60 €
16	202090251	1,10 €	202090251	1,10 €	202090321	1,60 €	202090321	1,80 €	202090501	1,90 €
17	202090202	0,70 €	202090202	0,70 €	202090322	0,72 €	202090322	0,72 €	202090502	0,80 €
18	202100209	0,10 €	202100209	0,10 €	202100329	0,30 €	202100329	0,30 €	202100509	0,55 €
18	205100209	0,50 €	205100209	0,50 €	205100329	1,50 €	205100329	1,50 €	205100509	2,75 €
19										
20	513000202	1,15 €	513000252	1,15 €	513000322	1,30 €	513000402	1,50 €	513000502	1,50 €
21	201610202	0,60 €	201610252	0,70 €	201610322	0,90 €	201610402	1,00 €	201610502	1,10 €
22	202010202	1,10 €	202010252	1,10 €	202010322	1,20 €	202010402	1,45 €	202010502	1,55 €
23	512000202	0,55 €	512000252	0,55 €	512000322	0,70 €	512000402	0,79 €	512000502	0,79 €
24	202030209	0,50 €	202030259	0,60 €	202030329	0,70 €	202030409	0,79 €	202030509	0,79 €
24	205030209	1,50 €	205030259	1,80 €	205100909	2,10 €	205030409	2,37 €	205030509	2,37 €
25	202060202	1,14 €	202060252	1,26 €	202060322	1,30 €	202060402	0,70 €	202060502	0,80 €
26	202080202	0,30 €	202080252	0,72 €	202080322	0,72 €	202080402	0,90 €	202080502	0,95 €
27	202110202	1,00 €	202110252	0,40 €	202110322	0,49 €	202110402	0,60 €	202110502	0,72 €
28	202070209	0,20 €	202070259	0,30 €	202070329	0,40 €	202070409	0,40 €	202070509	0,50 €
28	205070209	0,60 €	205070259	0,90 €	205070329	1,20 €	205120259	1,20 €	205070509	1,50 €
29	202120209	0,20 €	202070409	0,40 €	202120329	0,70 €	202120409	0,60 €	202070639	0,70 €
29	205120209	0,60 €	205120259	1,20 €	205120329	2,10 €	205120409	1,80 €	205070639	2,10 €
30	202130202	0,80 €	202130253	0,50 €	202130323	0,70 €	202130403	0,70 €	202130503	0,80 €
31	202170202		202170252		202170322		202170402		202170502	
32	202180202		202180252		202180322		202180402		202180502	
33	512020202	0,95 €	512020252	1,15 €	512020322	1,35 €	512020402	1,55 €	512020502	2,00 €
34	229060202		229060252		229060322		229060402		229060502	
35	900900202		900900252		900900322		900900402		900900502	
36	512300202		512300252		512300322		512300402		512300502	
37	512600202		512600252		512600322		512600402		512600502	

No	Ø63 Kod /Code	Fiyat (Adet) Price (Pcs)	Ø75 Kod /Code	Fiyat (Adet) Price (Pcs)	Ø90 Kod /Code	Fiyat (Adet) Price (Pcs)	Ø110 Kod /Code	Fiyat (Adet) Price (Pcs)
1	700006326	179,40 €	700007526	208,00 €	700009026	269,10 €	700011026	328,90 €
2	700006327	269,10 €	700007527	269,10 €	700009027	269,10 €	700011027	418,60 €
3	202050902		202050902		202050902		202050902	
4	100301371	0,90 €	100301371	0,90 €	100301371	0,90 €	100301371	0,90 €
5	291130905		291130905		291130905		291130905	
6	291139904		291139904		291139904		291139904	
7	201151969		201151969		201151969		201151969	
8	400267952		400267952		400267952		400267952	
9	400267962		400267962		400267962		400267962	
10	201600752		201600752		201600902		201600902	
11	K00201479		K00201479		K00201479		K00201479	
12	202050632	0,95 €	202050752	1,73 €	202050902	2,90 €	202051102	5,00 €
13	100300749	0,80 €	100300749	0,80 €	100300749	0,80 €	100300749	0,80 €
14	205040632	2,00 €	205040752	3,78 €	205040902	2,27 €	205041102	4,00 €
15	202040632	2,00 €	202040752	3,78 €	202040902	2,27 €	202041102	4,00 €
16	202090631	2,10 €	202090631	2,10 €	202090901	5,00 €	202090901	5,00 €
17	202090632	1,19 €	202090632	1,19 €	202090902	1,80 €	202090902	1,80 €
18	202100639	1,30 €	202100639	1,80 €	202030329	0,70 €	202030329	0,70 €
18	205100639	6,50 €	205100639	9,00 €	205100909	3,50 €	205100909	3,50 €
19	201150639	0,50 €	201150759	0,50 €	201150909	0,70 €	201150909	0,70 €
20	513000632	1,65 €	513000752	2,15 €	513000902	2,40 €	513001102	2,55 €
21	201610632	1,20 €	201610752	1,40 €	201610902	1,60 €	201611102	2,00 €
22	202010632	1,80 €	202010752	2,80 €	202010902	2,50 €	202011102	3,40 €
23	512000632	0,81 €	512000752	1,00 €	512000902	1,20 €	512001102	1,80 €
24	202030639	0,81 €	202030759	1,90 €	202030909	5,00 €	202031109	8,00 €
24	205030639	2,43 €	205030759	5,70 €	205030909	15,00 €	205031109	24,00 €
25	202060632	1,30 €	202060752	4,50 €	202060902	7,93 €	202061102	11,90 €
26	202080632	1,24 €	202080752	10,00 €	202080902	14,00 €	202081102	20,00 €
27	202110632	0,70 €	202110752	1,20 €	202110902	1,20 €	202111102	2,50 €
28	202070639	0,70 €	202070759	4,20 €	202070909	6,00 €	202071109	8,00 €
28	205070639	2,10 €	205070759	12,60 €	205070909	18,00 €	205071109	24,00 €
29	202120639	0,70 €	202120759	1,50 €	202120909	2,00 €	202121109	3,10 €
29	205120639	2,10 €	205120759	4,50 €	205120909	6,00 €	205121109	9,30 €
30	202130633	2,80 €	202130753	3,50 €	202130903	3,70 €	202131102	8,10 €
31	202170632							
32	202180632							
33	512020632	2,25 €	512020752	3,95 €	512020902	4,35 €	512021102	5,00 €
34	229060632		229060752		229060902		229061102	
35	900900632		900900752		900900902		900901102	
36	512300632							
37	512600632							

U-PVC Rakor Yedek Parça Listesi
 U-PVC Union Spare Parts List

No	Parça Part	Malzeme Material	Adet QTY
1	Rakor Gövde	U-PVC	1
2	Adaptör	U-PVC	1
3	Gövde O-Ring / Body O-Ring	EPDM / FPM	1
4	Somun / Nut	U-PVC	1
5	İç Diş Adaptör	U-PVC	1
6	Dış Diş Adaptör	U-PVC	1
7	Dış Yapıştırma Adaptör	U-PVC	1
8	Hortum Adaptörü	U-PVC	1
9	İç Diş Adaptör	BRASS	1
10	Dış Diş Adaptör	BRASS	1
11	İç Dişli Rakor Gövde	U-PVC	1
12	Dış Diş Rakor Gövde	U-PVC	1

U-PVC Çıplak Çalparalı Çekvalf Yedek Parça Listesi
 U-PVC Wafer Check Valve Spare Parts List

No	Parça Part	Malzeme Material	Adet QTY
1	Gövde / Body	U-PVC	1
2	Klape O-Ringi / Carrier O-Ring	EPDM / FPM	1
3	Klape / Clack	U-PVC	1
4	Yay / Spring	Stainless Steel	1
5	Gövde O-Ringi / Body O-Ring	EPDM / FPM	2
6	Klape Tapası / Clack Plug	U-PVC	2

No	Ø20 Kod /Code	Fiyat (Adet) Price (Pcs)	Ø25 Kod /Code	Fiyat (Adet) Price (Pcs)	Ø32 Kod /Code	Fiyat (Adet) Price (Pcs)	Ø40 Kod /Code	Fiyat (Adet) Price (Pcs)	Ø50 Kod /Code	Fiyat (Adet) Price (Pcs)
1	227050202	1,23 €	227050252	2,50 €	227050322	3,75 €	227050402	4,10 €	227050502	5,67 €
2	512000202	0,55 €	512000252	0,55 €	512000322	0,70 €	512000402	0,79 €	227010502	0,79 €
3	202030209	0,50 €	202030259	0,60 €	202030329	0,70 €	202030409	0,79 €	202030509	0,79 €
4	202010202	1,10 €	202010252	1,10 €	227020322	1,35 €	202010402	1,45 €	227020502	2,50 €
5	512020202	0,95 €	512020252	1,15 €	512020322	1,35 €	512020402	1,55 €	502020502	2,00 €
6			229060252		229060322		229060402		22906502	2,00 €
7	512300202	1,15 €	512300252	1,35 €	512300322	1,55 €	512300402	1,75 €	512300502	2,20 €
8	512600202	0,95 €	512600252	1,15 €	512600322	1,60 €	512600402	1,80 €	512600502	2,50 €
9	202180202		202180252		202180322		202180402		202180502	
10	202170202		202170252		202170322		202170402		202170502	
11	229050202	1,40 €	229050252	2,20 €	229050322	2,90 €	229050402	3,10 €	229050502	3,90 €
12	229090202		229090252		229090322		229090402		229090502	

No	Ø63 Kod /Code	Fiyat (Adet) Price (Pcs)	Ø75 Kod /Code	Fiyat (Adet) Price (Pcs)	Ø90 Kod /Code	Fiyat (Adet) Price (Pcs)	Ø110 Kod /Code	Fiyat (Adet) Price (Pcs)
1	227050632	6,54 €	227050752	10,00 €	227050902	11,20 €	227051102	13,77 €
2	227010632	0,85 €	512000752	1,00 €	512000902	1,30 €	228011102	2,07 €
3	202030639	0,81 €	202030759	1,90 €	202030909	5,00 €	202031109	8,00 €
4	227020632	2,43 €	205030759"	5,70 €	205030909	15,00 €	205031109"	24,00 €
5	227020632	3,30 €	227010752	7,10 €	227020902	10,00 €	227021102	12,00 €
6	512020632	2,25 €	512020752	3,95 €	512020902	4,35 €	512021102	5,00 €
7	229060632	2,25 €	229060752		229060902		229061102	
8	512300632	2,45 €	512300752	4,15 €	512300902	4,55 €	512301102	5,20 €
9	512600632	3,30 €	512600752	6,60 €	512600902	9,00 €	512601102	11,00 €
10	202180632		202180752		202180902		202181102	
11	202170632		202170752		202170902		202171102	
12	229050632	4,95 €	229050752	11,00 €	229050902	14,30 €	229051102	17,20 €
13	229090632		229090752		229090902		229091102	

No	Ø63 Kod /Code	Fiyat (Adet) Price (Pcs)	Ø75 Kod /Code	Fiyat (Adet) Price (Pcs)	Ø90 Kod /Code	Fiyat (Adet) Price (Pcs)	Ø110 Kod /Code	Fiyat (Adet) Price (Pcs)	Ø125 Kod /Code	Fiyat (Adet) Price (Pcs)
1	221020632	10,00 €	221020752	14,50 €	221020902	15,00 €	221021102	18,00 €	221021252	20,00 €
2	221160908	1,10 €	221160759	1,30 €	221160909	1,60 €	221161109	1,90 €	221161259	2,50 €
3	221160631	5,50 €	221160751	6,50 €	221160901	8,00 €	221161101	8,75 €	221161251	12,50 €
4	221030632	11,00 €	221030752	13,00 €	221030902	15,00 €	221031102	18,50 €	221031252	21,00 €
5	221170639	5,00 €	221170759	5,00 €	221170909	6,00 €	221171109	6,00 €	221171259	7,00 €
6	221150908	1,65 €	221150759	1,95 €	221150909	2,40 €	221151109	2,85 €	221151259	3,75 €
7	2211506631	8,00 €	221150751	9,75 €	221150901	10,00 €	221151101	12,75 €	221151251	18,75 €
8	221120902	1,00 €	221120902	1,00 €	221120902	1,00 €	221121102	1,00 €	221121102	1,00 €

No	Ø140 Kod /Code	Fiyat (Adet) Price (Pcs)	Ø160 Kod /Code	Fiyat (Adet) Price (Pcs)	Ø200 Kod /Code	Fiyat (Adet) Price (Pcs)	Ø225 Kod /Code	Fiyat (Adet) Price (Pcs)
1	221021402	23,50 €	221021602	26,00 €	221022002	32,00 €	221022252	36,00 €
2	221161409	3,75 €	221161609	4,50 €	221162009	6,00 €	221162259	8,00 €
3	221161401	12,50 €	221161601	15,50 €	221162001	20,00 €	221162251	21,00 €
4	221031402	23,00 €	221031602	26,00 €	221032002	32,00 €	221032252	36,00 €
5	221171409	7,00 €	221171609	7,00 €	221172009	8,00 €	221172259	8,00 €
6	221151409	4,75 €	221151609	6,75 €	221152009	9,00 €	221152259	12,00 €
7	221151401	18,75 €	221151601	22,50 €	221152001	29,00 €	221152251	30,00 €
8	221121102	1,00 €	221121102	1,00 €	221121102	1,00 €	221121102	1,00 €

No	Ø250 Kod /Code	Fiyat (Adet) Price (Pcs)	Ø280 Kod /Code	Fiyat (Adet) Price (Pcs)	Ø315 Kod /Code	Fiyat (Adet) Price (Pcs)	Ø400 Kod /Code	Fiyat (Adet) Price (Pcs)
1	221022502	70,00 €	221022502	110,00 €	22102315252	150,00 €	221024002	300,00 €
2	221162509	11,00 €	221162509	18,00 €	221163151	28,00 €	221164009	36,00 €
3	221162501	45,00 €	221162501	45,00 €	221163151	65,00 €	221164001	180,00 €
4	221032502	80,00 €	221032502	115,00 €	22103315252	150,00 €	221034002	300,00 €
5	221172509	15,00 €	221172509	15,00 €	221173159	20,00 €	221174009	40,00 €
6	221152509	16,50 €	221152509	30,00 €	221153159	42,00 €	221154009	54,00 €
7	221152501	66,00 €	221152501	66,00 €	221153151	150,00 €	221154001	200,00 €
8	221122502	1,00 €	221122502	1,00 €	221122502	2,00 €	221122502	5,00 €

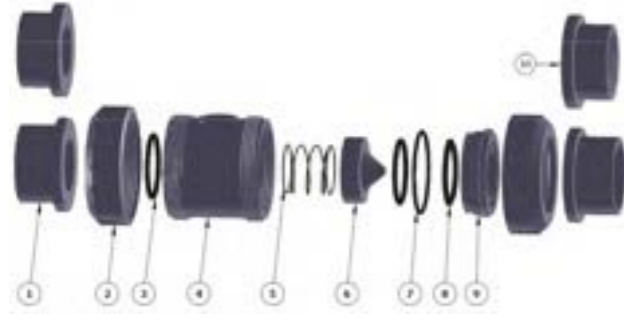
U-PVC Yaylı Çekvalfler Yedek Parça Listesi
 U-PVC True Union Spring Checkvalve Spare Parts List

No	Parça Part	Malzeme Material	Adet QTY
1	Kole	U-PVC	2
2	Somun / Union Nut	U-PVC	2
3	Gövde O-Ring	EPDM	2
4	Gövde / Body	U-PVC	1
5	Yay / Sprino	Stainless Stell 316	1
6	Klape / Valve	U-PVC	1
7	Dayama O-Ring	EPDM	1
8	Klape O-Ringi / Valve O-Ring	EPDM	1
9	Küre Dayama / Union Bush	U-PVC	1
10	İç Dişli Kole	U-PVC	2

No	Ø20 Kod /Code	Fiyat (Adet) Price (Pcs)	Ø25 Kod /Code	Fiyat (Adet) Price (Pcs)	Ø32 Kod /Code	Fiyat (Adet) Price (Pcs)	Ø40 Kod /Code	Fiyat (Adet) Price (Pcs)	Ø50 Kod /Code	Fiyat (Adet) Price (Pcs)
1	512000202	0,55 €	512000252	0,55 €	512000322	0,70 €	512000402	0,79 €	512000502	0,79 €
2	202010202	1,10 €	202010252	1,10 €	202010322	1,20 €	202010402	1,45 €	202010502	1,55 €
3	202030209	0,50 €	202030259	0,60 €	202030329	0,70 €	202030409	0,79 €	202030509	0,79 €
4	214040202	1,05 €	214040252	1,26 €	214040322	1,30 €	214040402	0,70 €	214040502	0,80 €
5	214050209	1,50 €	214050259	1,94 €	214040329	2,50 €	214040409	3,21 €	214040509	4,05 €
6	214060202	1,10 €	214060252	1,20 €	214060322	1,70 €	214060402	2,00 €	214060502	2,43 €
7	202120209	0,20 €	202070409	0,40 €	202120329	0,70 €	202120409	0,60 €	202070639	0,70 €
8	214060209	0,59 €	214060259	0,65 €	214060329	0,90 €	214060409	1,00 €	214060509	1,03 €
9	202130202	0,80 €	202130253	0,50 €	202130323	0,70 €	202130403	0,70 €	202130503	0,80 €
10	512020202	0,95 €	512020252	1,15 €	512020322	1,35 €	512020402	1,55 €	512020502	2,00 €

No	Ø63 Kod /Code	Fiyat (Adet) Price (Pcs)	Ø75 Kod /Code	Fiyat (Adet) Price (Pcs)	Ø90 Kod /Code	Fiyat (Adet) Price (Pcs)	Ø110 Kod /Code	Fiyat (Adet) Price (Pcs)
1	512000632	0,81 €	512000752	1,00 €	512000902	1,20 €	512001102	1,80 €
2	202010632	1,80 €	202010752	2,80 €	202010902	2,50 €	202011102	3,40 €
3	202030639	0,81 €	202030759	1,90 €	202030909	5,00 €	202031109	8,00 €
4	214040632	1,30 €	214040752	4,50 €	214040902	4,50 €	214041102	17,00 €
5	214040639	5,77 €	214040759	15,00 €	214040909	14,35 €	214041109	19,67 €
6	214060632	2,90 €	214060752	9,60 €	214060902	9,00 €	214061102	13,00 €
7	202120639	0,70 €	202120759	1,50 €	202120909	2,00 €	202121109	3,10 €
8	214060639	1,05 €	214060759	4,47 €	214060909	4,47 €	214061109	10,00 €
9	202130633	2,80 €	202130753	3,50 €	202130903	3,70 €	202131102	8,10 €
10	512020632	2,25 €	512020752	3,95 €	512020902	4,35 €	512021102	5,00 €

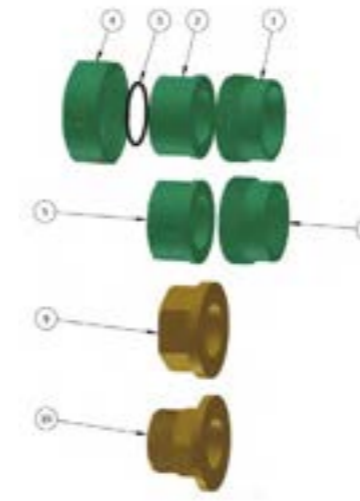
PP Rakor Yedek Parça Listesi
 PP Union Spare Parts List

No	Parça Part	Malzeme Material	Adet QTY
1	Rakor Gövde	PP	1
2	Adaptör	PP	1
3	Gövde O-Ring / Body O-Ring	EPDM / FPM	1
4	Somun / Nut	PP	1
5	İç Diş Adaptör	PP	1
9	İç Diş Adaptör	BRASS	1
10	Dış Diş Adaptör	BRASS	1
11	İç Dişli Rakor Gövde	PP	1

No	Ø20 Kod /Code	Fiyat (Adet) Price (Pcs)	Ø25 Kod /Code	Fiyat (Adet) Price (Pcs)	Ø32 Kod /Code	Fiyat (Adet) Price (Pcs)	Ø40 Kod /Code	Fiyat (Adet) Price (Pcs)	Ø50 Kod /Code	Fiyat (Adet) Price (Pcs)
1	406050202	1,10 €	406050252	2,70 €	406050322	2,70 €	406050402	2,90 €	406050502	3,70 €
2	512030202	0,66 €	512030252	0,66 €	512030322	0,84 €	512030402	0,95 €	406010502	0,95 €
3	202030209	0,50 €	202030259	0,60 €	202100909	0,70 €	202030409	0,70 €	202030509	0,90 €
4	2050302096	1,80 €	205030259	1,90 €	205100909	2,00 €	205030409	2,00 €	205030509	2,90 €
5	400010202	1,20 €	400010252	1,50 €	400010322	1,90 €	400010402	2,10 €	406020502	2,50 €
9	512240202	1,14 €	512240252	1,38 €	512240322	1,62 €	512240402	1,86 €	512240502	2,40 €
10	202180202	2,55 €	202180252	4,10 €	202180322	5,20 €	202180402	8,00 €	202180502	14,50 €
11	408050202	1,40 €	408050252	2,20 €	408050322	2,90 €	408050402	3,10 €	408050502	3,90 €

No	Ø63 Kod /Code	Fiyat (Adet) Price (Pcs)	Ø75 Kod /Code	Fiyat (Adet) Price (Pcs)	Ø90 Kod /Code	Fiyat (Adet) Price (Pcs)	Ø110 Kod /Code	Fiyat (Adet) Price (Pcs)
1	406050632	4,35 €	406050752	9,70 €	406050902	13,85 €	406051102	16,60 €
2	406010632	0,97 €	512030752	1,20 €	512030902	1,56 €	512031102	2,48 €
3	202030639	1,30 €	202030759	2,20 €	202030909	2,90 €	202031109	5,00 €
4	205030639	3,10 €	205030759	3,80 €	205030909	4,20 €	406031109	6,50 €
5	406020632	3,30 €	400010752	7,50 €	406020902	11,50 €	400010902	14,30 €
9	512240632	2,70 €	512240752	4,74 €	512240902	5,22 €	512241102	6,00 €
10	202180632	28,75 €						
11	408050632	4,95 €	408050752	11,00 €	408050902	14,30 €	408051102	17,20 €

PP Küresel Vana Yedek Parça Listesi
 PP True Union Ball Valves Spare Parts List



No	Parça Part	Malzeme Material	Adet QTY
1	Pnomatik Aktuatör		1
2	Elektrikli Aktuatör		1
3	Kol Kapağı / Handle Cover	PVC	1
4	Civata / Screw	INOX	1
5	Kol / Handle (ASİT VANA KOL)	ABS	1
6	Kol / Handle (SU VANA KOL)	ABS	1
7	Somun / Nut	INOX	4
8	Çark / Index Plate	PP GF	1
9	Mandal / Lever Catch	PP GF	1
10	Adaptör Ara Parça	PP	1
11	ISO 4762 M8 x 25 --- 25S	INOX	4
12	Kol Kapağı / Handle Cover	ABS	1
13	Civata / Screw	INOX	1
14	Kol / Handle (ASİT)	ABS	1
15	Kol / Handle (SU)	ABS	1
16	Pim Uzatma Parçası	PP	1
17	Pim / Step	PP	1
18	Pim O-Ringi / Step O-Ring	EPDM / FPM	2
19	Vida / Screw	INOX	4

No	Parça Part	Malzeme Material	Adet QTY
20	Flaş / Flange	PP	2
21	Kole Ara Parça	PP	2
22	Somun / Union Nut	PP	2
23	Adaptör	PP	4
24	Gövde O-Ringi / Body O-Ring	EPDM / FPM	2
25	Gövde / Body	PP	1
26	Conta / Gasket	TEFLON	2
27	Küre / Ball	PP	1
28	Conta Altı O-Ring / Backing Seals	EPDM / FPM	2
29	Dayama O-Ring	EPDM / FPM	1
30	Küre Dayama / Union Bush	PP	1
31	Dış Dış Adaptör	BRASS	1
32	İç Dış Adaptör	BRASS	1
33	İç Dişli Adaptör	PP	1
34	Dış Dişli Adaptör	PP	1
35	Adaptör	HDPE	1
36	Dış Yapıştırma Adaptör	PP	1
37	Hortum Adaptörü	PP	1

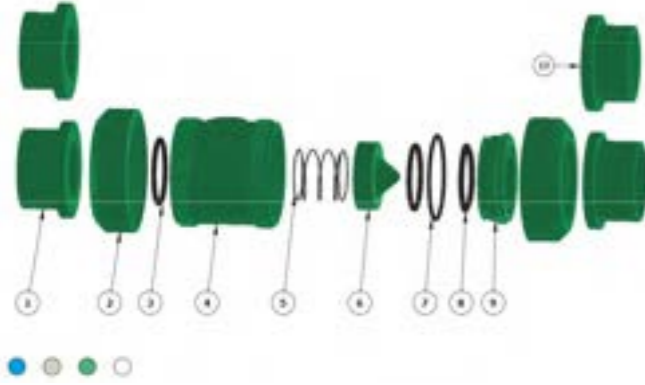

No	Ø20 Kod /Code	Fiyat (Adet) Price (Pcs)	Ø25 Kod /Code	Fiyat (Adet) Price (Pcs)	Ø32 Kod /Code	Fiyat (Adet) Price (Pcs)	Ø40 Kod /Code	Fiyat (Adet) Price (Pcs)	Ø50 Kod /Code	Fiyat (Adet) Price (Pcs)
1	700002026	202,40 €	700002526	202,40 €	700003226	202,40 €	700004026	212,10 €	700006326	240,10 €
2	700002027	225,10 €	700002527	225,10 €	700003227	225,10 €	700004027	245,20 €	700005027	245,20 €
3										
4										
5										
6										
7										
8										
9										
10	201600202	2,00 €	201600202	2,00 €	201600322	3,00 €	201600322	3,00 €	201600502	3,50 €
11	K00201479	1,50 €	K00201479	1,50 €	K00201479	1,50 €	K00201479	1,50 €	K00201479	1,50 €
12	202050202	0,50 €	202050202	0,50 €	202050322	0,73 €	202050402	0,82 €	202050502	0,86 €
13	100304199	0,50 €	100304199	0,50 €	100304199	0,50 €	100304199	0,50 €	100304199	0,50 €
14	205040202	1,10 €	205040202	1,10 €	205040322	1,60 €	205040402	1,80 €	205040502	1,90 €
15	202040202	1,10 €	202040202	1,10 €	202040322	1,60 €	202040402	1,80 €	202040502	1,90 €
16	202090251	1,50 €	202090251	1,50 €	202090321	1,60 €	202090321	1,60 €	202090501	1,90 €
17	400090202	0,90 €	400090202	0,90 €	400090322	1,00 €	400090322	1,00 €	400090502	1,25 €
18	202100209	0,10 €	202100209	0,10 €	202100329	0,20 €	202100329	0,20 €	202100509	0,30 €
19	205100209	0,90 €	205100209	0,90 €	205100329	1,10 €	205100329	1,20 €	205100509	1,30 €
20	513010202	1,38 €	513010252	1,38 €	513010322	1,56 €	513010402	1,80 €	513010502	1,80 €
21	201310202	1,80 €	201310252	1,80 €	201310322	2,20 €	201310402	2,40 €	201310502	2,60 €
22	400010202	1,20 €	400010252	1,50 €	400010322	1,90 €	400010402	2,10 €	400010502	3,00 €
23	512030202	0,66 €	512030252	0,66 €	512030322	0,84 €	512030402	0,95 €	512030502	0,95 €
24	202030209	0,50 €	202030259	0,60 €	202100909	0,70 €	202030409	0,70 €	202030509	0,90 €
25	205030209	1,20 €	205030259	1,30 €	202100909	1,40 €	205030409	1,40 €	205030509	1,90 €
26	400060202	2,20 €	400060252	2,36 €	400060322	3,30 €	400060402	4,40 €	400060502	8,55 €
27	205080209	2,50 €	205080259	3,50 €	205080329	5,50 €	205080409	7,00 €	205080509	9,00 €
28	400110202	1,20 €	400110252	1,30 €	400110322	1,70 €	400110402	2,70 €	400110502	4,15 €
29	202070209	1,30 €	202070259	1,20 €	202070329	1,40 €	202120259	1,30 €	202070509	1,70 €
30	205070209	2,10 €	205070259	2,30 €	205070329	2,60 €	205120259	2,60 €	205070509	2,70 €
31	202120209	0,40 €	202120259	0,50 €	202120329	0,70 €	202120409	0,70 €	202070639	0,85 €
32	205120209	1,10 €	205120259	1,20 €	205120329	1,30 €	205120409	1,30 €	205070639	1,85 €
33	400130202	1,00 €	400130252	1,20 €	400130322	1,90 €	400130402	1,95 €	400130502	2,15 €
34	202170202	3,05 €	202170252	5,90 €	202170322	7,80 €	202170402	11,40 €	202170502	17,50 €
35	202180202	2,55 €	202180252	4,90 €	202180322	6,30 €	202180402	9,90 €	202180502	15,55 €
36	512040202	1,14 €	512040252	1,38 €	512040322	1,62 €	512040402	1,86 €	512040502	2,40 €
37	229100202		229100252		229100322		229100402		229100502	
38	758160209		758160259		758160329		758160409		758160509	
39	512310202		512310252		512310322		512310402		512310502	
40	512610202		512610252		512610322		512610402		512610502	

No	Ø63 Kod /Code	Fiyat (Adet) Price (Pcs)	Ø75 Kod /Code	Fiyat (Adet) Price (Pcs)	Ø90 Kod /Code	Fiyat (Adet) Price (Pcs)	Ø110 Kod /Code	Fiyat (Adet) Price (Pcs)
1	700006326	244,40 €	700007526	306,14 €	700009026	326,72 €	700011026	372,41 €
2	700006327	286,14 €	700007527	315,00 €	700009027	343,24 €	700011027	361,50 €
3	2022050632	0,90 €	2022050752	0,90 €	2022050902	0,90 €	2022051102	0,90 €
4	202501499	2,10 €	202501499	2,10 €	202501499	2,10 €	202501499	2,10 €
5	291130905	13,00 €	291130905	13,00 €	291130905	13,00 €	291131105	15,00 €
6	291139904	13,00 €	291139904	13,00 €	291139904	13,00 €	291131104	15,00 €
7	201151969	0,80 €	201151969	0,80 €	201151969	0,80 €	201151969	0,80 €
8	400267952	6,80 €	400267952	6,80 €	400267952	6,80 €	400267952	6,80 €
9	400267962	6,00 €	400267962	6,00 €	400267962	6,00 €	400267962	6,00 €
10	201600752	4,50 €	201600752	4,50 €	201600902	5,00 €	201600902	5,00 €
11	K00201479	4,50 €	K00201479	1,50 €	K00201479	1,50 €	K00201479	1,50 €
12	202050632	0,95 €	202050752	1,73 €	202050902	2,27 €	202051102	3,41 €
13	100300749	0,80 €	100300749	0,80 €	100300749	0,80 €	100300749	0,80 €
14	205040632	2,10 €	205040752	3,80 €	205040902	5,00 €	205041102	7,50 €
15	202040632	2,10 €	202040752	3,80 €	202040902	5,00 €	202041102	7,50 €
16	202090631	2,10 €	202090631	3,80 €	202090901	5,00 €	202090901	7,50 €
17	400090632	1,55 €	400090632	1,55 €	400090902	3,00 €	400090902	3,00 €
18	202100639	0,50 €	202100639	0,50 €	202100909	0,70 €	202100909	0,70 €
19	205100639	1,50 €	205100639	1,50 €	205100909	1,70 €	205100909	1,70 €
20	201150639	0,50 €	201150759	0,50 €	201150759	0,70 €	201150909	0,70 €
21	513010632	1,98 €	513010752	2,58 €	513010902	2,88 €	513011102	3,06 €
22	201310632	3,80 €	201310752	3,80 €	201310902	4,20 €	201311102	4,60 €
23	400010632	3,70 €	400010752	7,50 €	400010902	11,50 €	40011102	14,30 €
24	512030632	0,97 €	512030752	4,20 €	512030902	1,56 €	512031102	2,48 €
25	202030639	1,30 €	202030759	2,20 €	202030909	2,90 €	202031109	5,00 €
26	205030639	2,30 €	205030759	3,20 €	205030909	3,90 €	205031109	6,00 €
27	400060632	8,45 €	400060752	28,00 €	400060902	32,00 €	400061102	42,00 €
28	205080639	11,00 €	205080759	14,00 €	205080909	18,00 €	205081109	24,00 €
29	400110632	6,15 €	400110752	13,30 €	400110902	19,30 €	400111102	24,00 €
30	202070639	1,70 €	202070759	2,10 €	202070909	2,30 €	202071109	3,10 €
31	205070639	2,70 €	205070759	3,10 €	205070909	3,30 €	205071109	4,10 €
32	202120639	0,90 €	202030909	3,00 €	202120909	3,90 €	202121109	5,60 €
33	205120639	1,90 €	205030909	4,00 €	205120909	4,90 €	205121109	6,60 €
34	400130632	2,35 €	400130752	4,25 €	400130902	5,35 €	400131102	8,20 €
35	202170632	40,05 €						
36	202180632	34,55 €						
37	512040632	2,70 €	512040752	4,74 €	512040902	5,22 €	512041102	6,00 €
38	229100632		229100752		229100902		229101102	
39	758160639		758000012		758160909		758161109	
40	512310632		512310752		512310902		512311102	
41	512610632		512610752		512610902		512611102	

PP Yaylı Çekvalfler Yedek Parça Listesi
 PP True Union Spring Checkvalve Spare Parts List

No	Parça Part	Malzeme Material	Adet QTY
1	Somun / Union Nut	PPRC	2
2	Bağl. Parçası / End Connector	PPRC	2
3	Bağl. Parçası / End Connector Thr.	PPRC	2
4	Gövde O-Ringi / Body O-Ring	EPDM	2
5	Gövde / Body	PPRC	1
6	Yay / Spring	INOX	1
7	Subap / Subap	PPRC	1
8	Subap O-Ringi / Carrier O-Ring	EPDM	1
9	Subap Dayama / Valve Bush	PPRC	1
10	Sıkıştırma O-Ringi / Carrier O-Ring	EPDM	1

No	Ø20 Kod /Code	Fiyat (Adet) Price (Pcs)	Ø25 Kod /Code	Fiyat (Adet) Price (Pcs)	Ø32 Kod /Code	Fiyat (Adet) Price (Pcs)	Ø40 Kod /Code	Fiyat (Adet) Price (Pcs)	Ø50 Kod /Code	Fiyat (Adet) Price (Pcs)
1	400010202	1,20 €	400010252	1,50 €	400010322	1,90 €	400010402	2,10 €	400010502	3,00 €
2	512030202	0,66 €	512030252	0,66 €	512030322	0,84 €	512030402	0,95 €	512030502	0,95 €
3	512040202	1,14 €	512040252	1,38 €	512040322	1,62 €	512040402	1,86 €	512040502	2,40 €
4	202030209	0,50 €	202030259	0,60 €	202100909	0,70 €	202030409	0,70 €	202030509	0,90 €
5	403040202	2,55 €	403040252	3,85 €	403040322	4,85 €	403040402	6,90 €	403040502	11,00 €
6	214050209	1,95 €	214050259	2,15 €	214050329	2,50 €	214050409	2,90 €	214050509	3,10 €
7	403060202	1,50 €	403060252	1,80 €	403060322	2,00 €	403060402	2,50 €	403060502	4,00 €
8	202070209	1,13 €	202070259	0,20 €	202070329	0,40 €	202070409	0,50 €	202070509	0,70 €
9	400130202	1,00 €	400130252	1,20 €	400130322	1,90 €	400130402	1,95 €	400130502	2,15 €
10	202120209	0,40 €	212120259	0,50 €	202120329	0,70 €	202120409	0,70 €	202070639	0,85 €

No	Ø63 Kod /Code	Fiyat (Adet) Price (Pcs)	Ø75 Kod /Code	Fiyat (Adet) Price (Pcs)	Ø90 Kod /Code	Fiyat (Adet) Price (Pcs)	Ø110 Kod /Code	Fiyat (Adet) Price (Pcs)
1	400010632	3,70 €	400010752	7,50 €	400010902	11,50 €	400011102	14,30 €
2	512030632	0,97 €	512030752	1,20 €	512030902	1,56 €	512031102	2,48 €
3	512040632	2,70 €	512040752	4,74 €	512040902	5,22 €	512041102	6,00 €
4	202030639	1,30 €	202030759	2,20 €	202030909	2,90 €	202031109	5,00 €
5	403040632	12,50 €	403040752	29,00 €	403040902	39,00 €	403041102	50,00 €
6	214050639	3,75 €	214050759	5,25 €	214050909	6,50 €	221171109	7,80 €
7	403060632	6,00 €	403060752	11,00 €	403060902	13,00 €	403061102	17,00 €
8	202070639	0,70 €	202070759	13,00 €	202070909	1,70 €	202071109	2,20 €
9	400130632	2,35 €	400130752	4,25 €	400130902	5,35 €	400131102	8,20 €
10	202120639	1,25 €	202030909	3,00 €	202120909	3,90 €	202121109	5,60 €

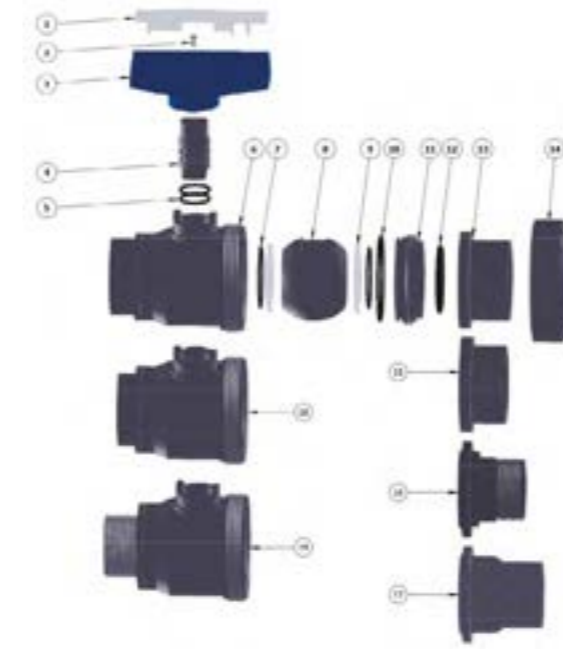
Tek Taraflı Tek Taraf Dişli Vana
 Single Union One Side Threaded Ball Valve

No	Parça Part	Malzeme Material	Adet QTY
1	Kol Kapağı / Handle Cover	U-PVC	1
2	Civata / Screw	INOX	1
3	Kol / Handle	ABS	1
4	Pim / Step	U-PVC	1
5	Pim O-Ring / Step O-Ring	EPDM	2
6	Gövde / Body	U-PVC	1
7	Conta Altı O-Ring / Backing Seals	EPDM	2
8	Küre / Ball	U-PVC	1
9	Küre Contası / Ball Gasket	HDPE	2
10	Dayama O-Ring	EPDM	1
11	Küre Dayama / Union Bush	U-PVC	1
12	Gövde O-Ring / Body O-Ring	EPDM	1
13	Adaptör	U-PVC	1
14	Somun / Union Nut	U-PVC	1
15	İç Dişli Adaptör	U-PVC	1
16	Dıştan Dişli Adaptör	U-PVC	1
17	İç Diş Yapıştırma Adaptör	U-PVC	1
18	İç Diş Gövde / Body	U-PVC	1
19	Dış Diş Gövde / Body	U-PVC	1

No	Ø20 Kod /Code	Fiyat (Adet) Price (Pcs)	Ø25 Kod /Code	Fiyat (Adet) Price (Pcs)	Ø32 Kod /Code	Fiyat (Adet) Price (Pcs)	Ø40 Kod /Code	Fiyat (Adet) Price (Pcs)	Ø50 Kod /Code	Fiyat (Adet) Price (Pcs)
1	202050202	0,50 €	202050202	0,50 €	202050322	0,70 €	202050402	0,80 €	202050502	0,80 €
2	100304199	1,10 €	100304199	1,10 €	100304199	1,60 €	100304199	1,80 €	202150329	1,90 €
3	202040202	1,10 €	202040202	1,10 €	202040322	1,60 €	202040402	1,80 €	202040502	1,90 €
4	202090202	0,70 €	202090202	0,70 €	202090322	0,80 €	202090322	0,80 €	202090502	1,00 €
5	202100209	0,10 €	202100209	0,10 €	202100329	0,20 €	202100329	0,20 €	202100509	0,30 €
6	232060202	1,80 €	232060252	2,10 €	232060322	2,90 €	232060402	3,80 €	232060502	7,00 €
7	202070209	0,20 €	202070259	0,20 €	202070329	0,40 €	202120259	0,50 €	202070509	0,70 €
8	202110202	1,00 €	202110252	1,10 €	202110322	1,40 €	202110402	2,20 €	202110502	3,50 €
9	202080202	0,30 €	202080252	0,40 €	202080322	0,50 €	202080402	0,60 €	202080502	0,70 €
10	202120209	0,40 €	202120259	0,50 €	202120329	0,70 €	202120409	0,70 €	202070639	0,85 €
11	202130202	0,80 €	202130252	1,00 €	202130322	1,60 €	202130402	1,75 €	202130502	1,95 €
12	202030209	0,50 €	202030259	0,60 €	202100909	0,70 €	202030409	0,70 €	202030509	0,90 €
13	512000202	0,55 €	512000252	0,55 €	512000322	0,70 €	512000402	0,79 €	512000502	0,79 €
14	202010202	1,10 €	202010252	1,30 €	202010322	1,60 €	202010402	1,80 €	202010502	2,50 €
15	512020202	0,95 €	512020252	1,11 €	512020322	1,35 €	512020402	1,55 €	512020502	2,00 €
16	229060202		229060252		229060322		229060402		229060502	
17	512110202		512110252		512110322		512110402		512110502	
18	232260202	1,80 €	232260252	2,10 €	232260322	2,90 €	232260402	3,80 €	232260502	7,00 €
19	232660202	1,80 €	232660252	2,10 €	232660322	2,90 €	232660402	3,80 €	232660502	7,00 €

No	Ø63 Kod /Code	Fiyat (Adet) Price (Pcs)	Ø75 Kod /Code	Fiyat (Adet) Price (Pcs)	Ø90 Kod /Code	Fiyat (Adet) Price (Pcs)	Ø110 Kod /Code	Fiyat (Adet) Price (Pcs)
1	202050632	0,80 €	202050752	0,90 €	202050902	1,10 €	202051102	2,10 €
2	202150329	2,10 €	202150329	3,80 €	202150329	5,00 €	202150329	7,50 €
3	202040632	2,10 €	202040752	3,80 €	202040902	5,00 €	202041102	7,50 €
4	202090632	1,30 €	202090632	1,30 €	202090902	2,50 €	202090902	2,50 €
5	202100639	0,50 €	202100639	0,50 €	202100909	0,70 €	202100909	0,70 €
6	232060632	15,00 €	232060752	20,00 €	232060902	25,00 €	232061102	35,00 €
7	202070639	0,70 €	202070759	1,30 €	202070909	1,70 €	202071109	2,20 €
8	202110632	5,20 €	202110752	11,50 €	202110902	15,00 €	202111102	20,00 €
9	202080632	0,70 €	202080752	1,00 €	202080902	1,20 €	202081102	1,40 €
10	202120639	2,80 €	202030909	3,00 €	202120909	3,90 €	202121109	5,60 €
11	202130632	2,10 €	202130752	3,80 €	202130902	4,90 €	202131102	6,50 €
12	202030639	1,30 €	202030759	2,20 €	202030909	2,90 €	202031109	5,00 €
13	512000632	0,81 €	512000752	1,00 €	512000902	1,30 €	512001102	1,75 €
14	202010632	3,30 €	202010752	6,60 €	202010902	9,00 €	202011102	11,00 €
15	512020632	2,25 €	512020752	3,95 €	512020902	4,35 €	512021102	5,00 €
16	229060632		229060752		229060902		229061102	
17	512110632		512110752		512110902		512111102	
18	232260632	15,00 €	232260752	20,00 €	232260902	25,00 €	232261102	35,00 €
19	232660632	15,00 €	232660752	20,00 €	232660902	25,00 €	232661102	35,00 €

Kaplin Yedek Parça Listesi PN 16
 Spare Parts For Compression Fittings PN 16

SOMUN / NUT

Çap Dia	Kod Code	Fiyat (Adet) Price (Pcs)	Poşet Adet Bag Pcs
20	EX232300202	0,18 €	1
25	EX232300252	0,24 €	1
32	EX232300322	0,25 €	1
40	EX232300402	0,55 €	1
50	EX232300502	0,86 €	1
63	EX232300632	0,94 €	1
75	EX232300752	2,32 €	1
90	EX232300902	2,64 €	1
110	EX232301102	5,40 €	1

POM KAPLİN SIKMA PARÇASI / LOCKING RING

Çap Dia	Kod Code	Fiyat (Adet) Price (Pcs)	Poşet Adet Bag Pcs
20	EX232110202	0,05 €	1
25	EX232110252	0,06 €	1
32	EX232110322	0,06 €	1
40	EX232110402	0,14 €	1
50	EX232110502	0,22 €	1
63	EX232110632	0,23 €	1
75	EX232110752	0,58 €	1
90	EX232110902	0,66 €	1
110	EX232111102	1,35 €	1

İÇ KOLE / O-RING HOLDER

Çap Dia	Kod Code	Fiyat (Adet) Price (Pcs)	Poşet Adet Bag Pcs
20	EX70100020	0,02 €	1
25	EX70100025	0,03 €	1
32	EX70100032	0,03 €	1
40	EX70100040	0,06 €	1
50	EX70100050	0,10 €	1
63	EX70100063	0,11 €	1
75	EX70100075	0,26 €	1
90	EX70100090	0,30 €	1
110	EX70100110	0,61 €	1

CONTA / O-RING

Çap Dia	Kod Code	Fiyat (Adet) Price (Pcs)	Poşet Adet Bag Pcs
20	EX70000209	0,14 €	100
25	EX70000259	0,18 €	100
32	EX70000329	0,19 €	100
40	EX70000409	0,41 €	100
50	EX70000509	0,65 €	100
63	EX70000639	0,70 €	100
75	EX70000759	1,74 €	50
90	EX70000909	1,98 €	50
110	EX700001109	4,05 €	50

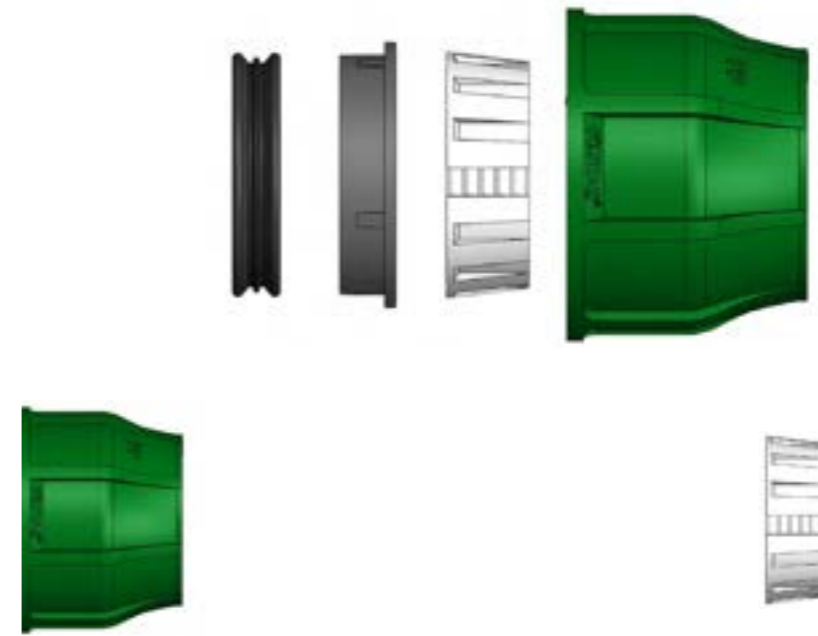
Kaplin Yedek Parça Listesi PN10
 Spare Parts For Compression Fittings PN10

SOMUN / NUT

Çap Dia	Kod Code	Fiyat (Adet) Price (Pcs)	Poşet Adet Bag Pcs
20	GR232300202	0,16 €	1
25	GR232300252	0,21 €	1
32	GR232300322	0,22 €	1
40	GR232300402	0,48 €	1
50	GR232300502	0,58 €	1
63	GR232300632	0,82 €	1
75	GR232300752	2,01 €	1
90	GR232300902	2,29 €	1
110	GR232301102	4,70 €	1

POM KAPLİN SIKMA PARÇASI / LOCKING RING

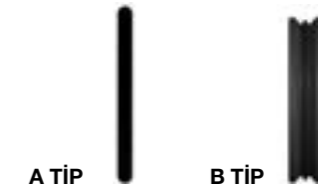
Çap Dia	Kod Code	Fiyat (Adet) Price (Pcs)	Poşet Adet Bag Pcs
20	GR232110202	0,04 €	1
25	GR232110252	0,05 €	1
32	GR232110322	0,05 €	1
40	GR232110402	0,12 €	1
50	GR232110502	0,15 €	1
63	GR232110632	0,20 €	1
75	GR232110752	0,50 €	1
90	GR232110902	0,57 €	1
110	GR232111102	1,17 €	1

İÇ KOLE / O-RING HOLDER

Çap Dia	Kod Code	Fiyat (Adet) Price (Pcs)	Poşet Adet Bag Pcs
20	GR70100020	0,02 €	1
25	GR70100025	0,02 €	1
32	GR70100032	0,02 €	1
40	GR70100040	0,05 €	1
50	GR70100050	0,07 €	1
63	GR70100063	0,09 €	1
75	GR70100075	0,23 €	1
90	GR70100090	0,26 €	1
110	GR70100110	0,53 €	1

CONTA / O-RING

Çap Dia	Kod Code	Fiyat (Adet) Price (Pcs)	Poşet Adet Bag Pcs
20	GR70000209	0,12 €	100
25	GR70000259	0,16 €	100
32	GR70000329	0,16 €	100
40	GR70000409	0,36 €	100
50	GR70000509	0,44 €	100
63	GR70000639	0,61 €	100
75	GR70000759	1,51 €	50
90	GR70000909	1,72 €	50
110	GR700001109	3,52 €	50

Since 1977



PIMTAS®

PLASTİK İNŞ. MALZ.SAN. VE TİC. A.Ş.



Gebze Plastikçiler Organize San. Böl. Cumhuriyet Cad. No:52 Gebze/KOCAELİ/TÜRKİYE

+90 262 751 24 24 +90 262 751 42 04 pimtas@pimtas.com

www.pimtas.com / www.pimtasshop.com